

EagleCals  
EC#47

1/72  
 1/48  1/32

eagle  
EDITIONS LTD.

Messerschmitt  
Bf 109 G-6 Trop  
JG 27, JG 51

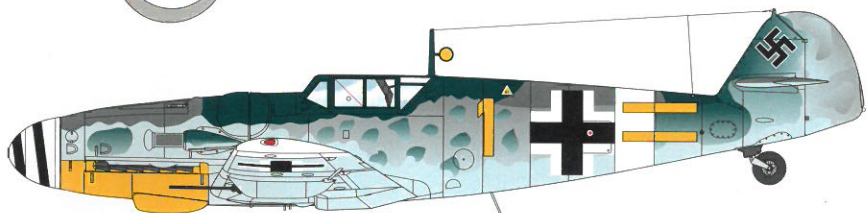

Bf 109 G-6 Trop  
Obt. Dietrich Boesler 12./JG 27

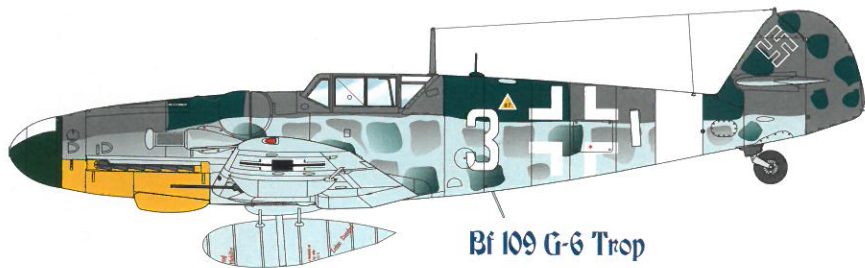

Bf 109 G-6 Trop  
Uffz. Franz Stadler 7./JG 27

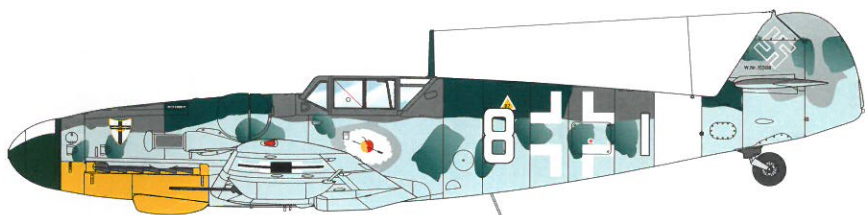

Bf 109 G-6 Trop  
7./JG 27

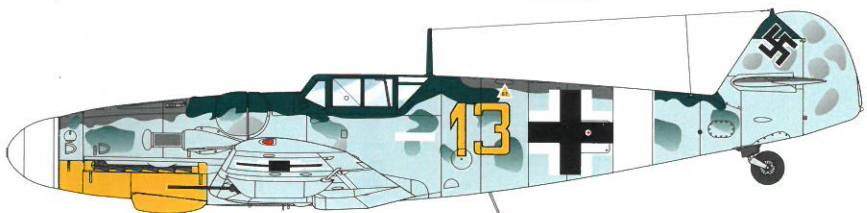

Bf 109 G-6 Trop  
II./JG 51

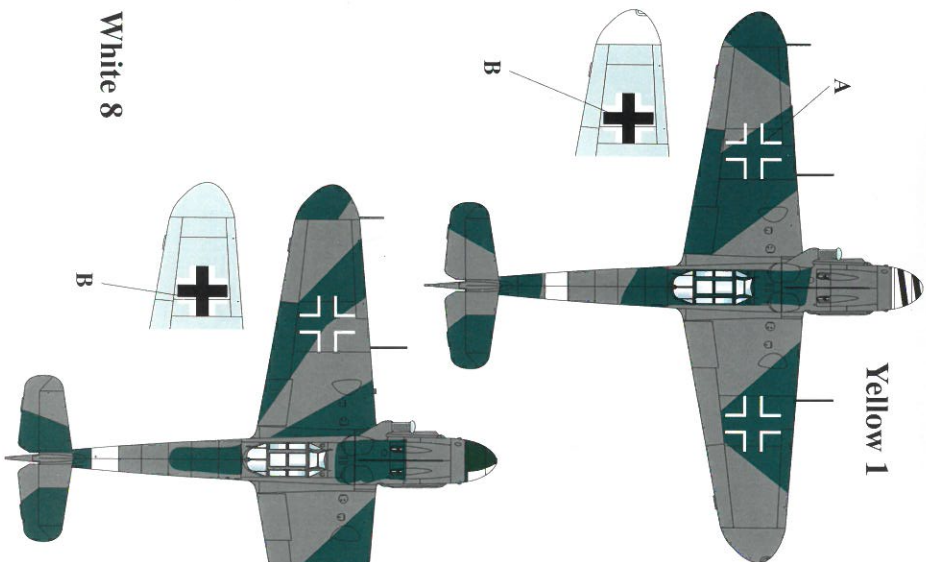

Yellow 1

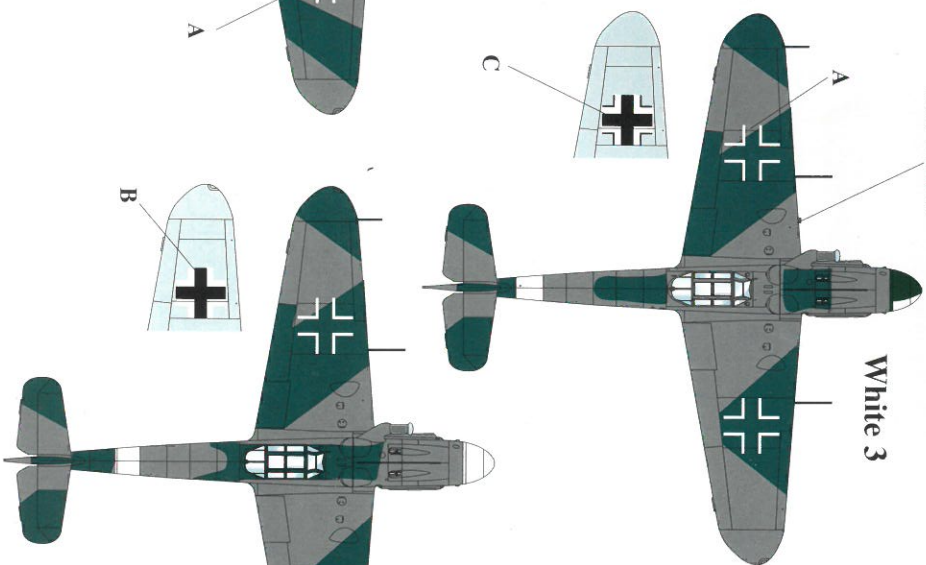

White 3

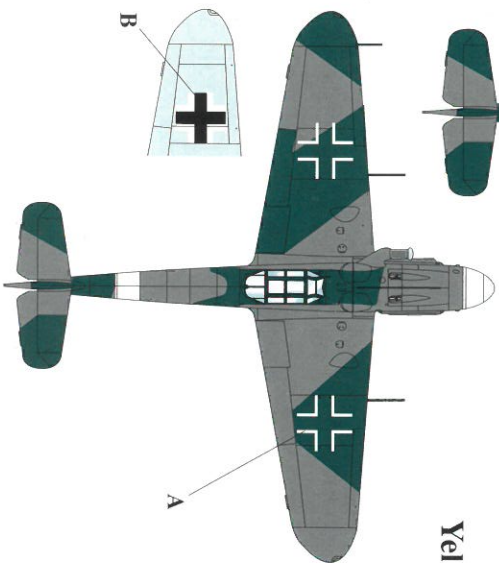

Yellow 13

○ 1/48  
○ 1/72  
○ 1/32

Templates for  
'Yellow 1' Pennant

White 8

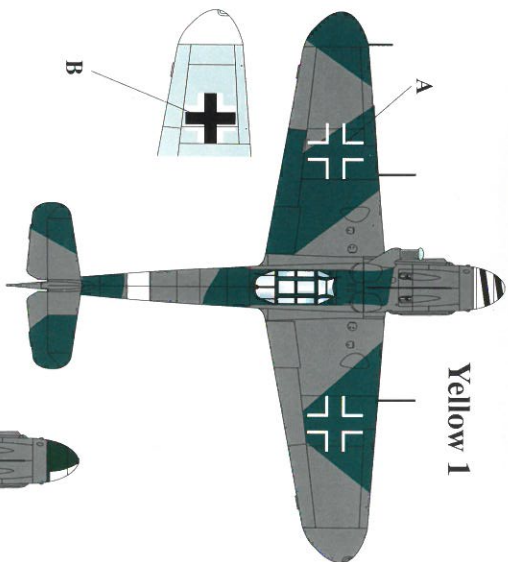
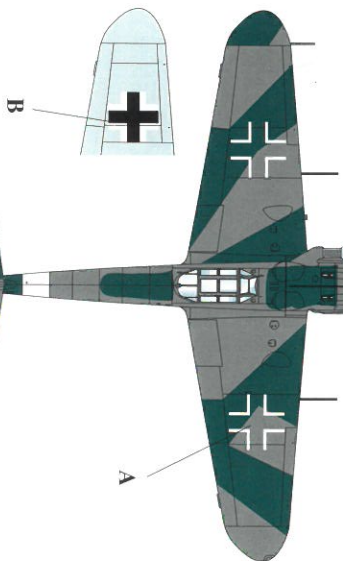

Gun camera

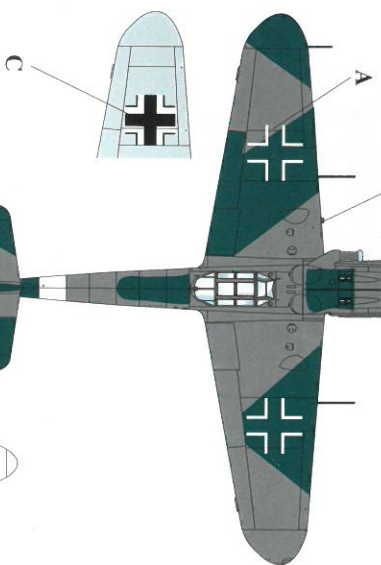

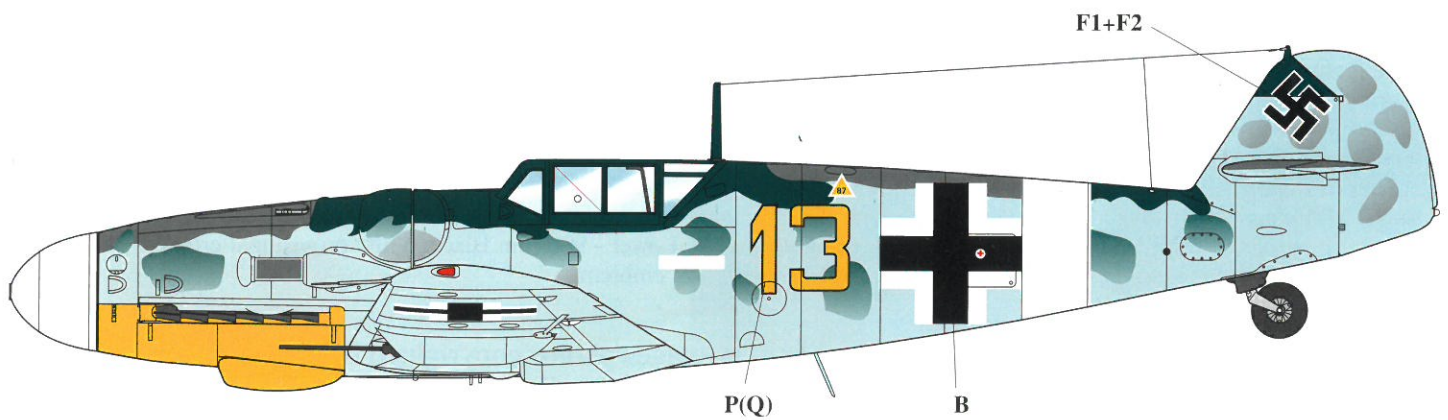
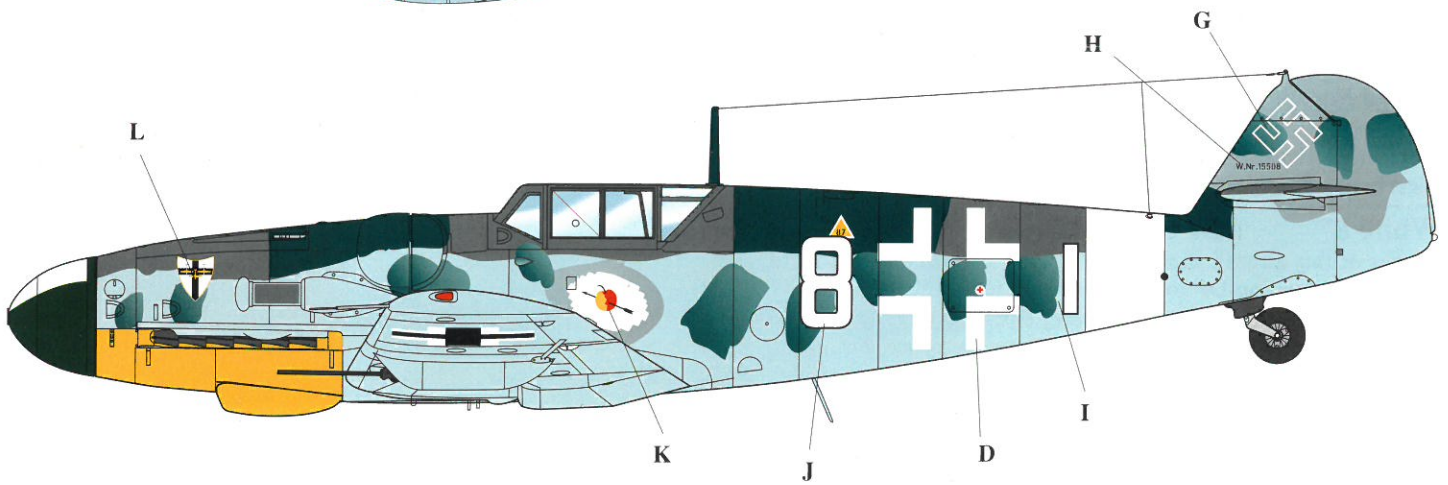
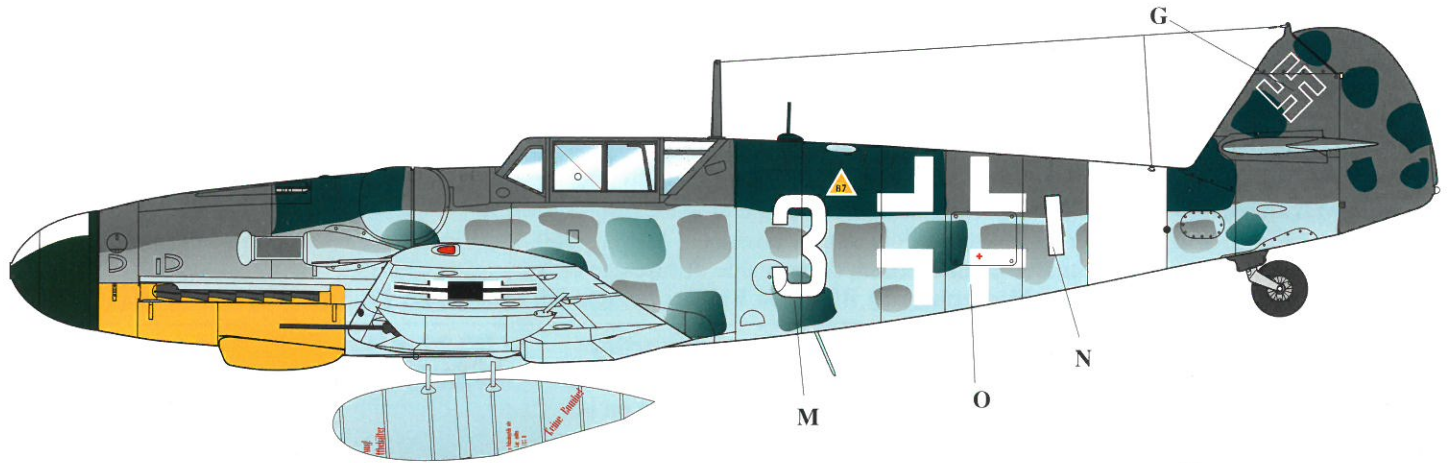
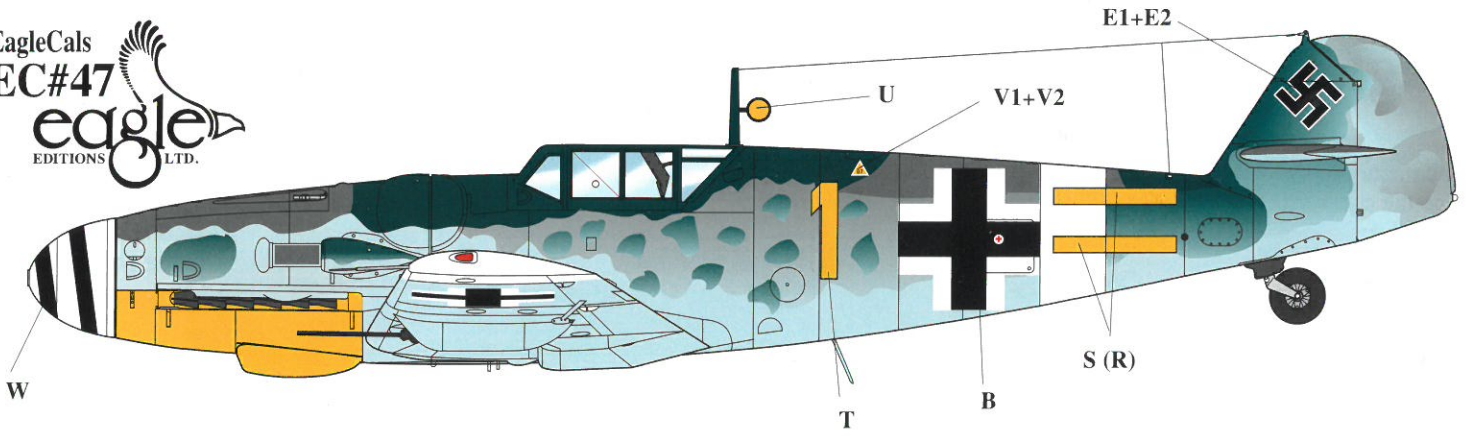

Manufactured in greater numbers than any other Messerschmitt 109 variant, the G-6 has always been very popular with the modelers considered to be the classic Bf 109 by many. Luftwaffe pilots complained the *Beule* or bumps covering the breaches of the MG 131 13 mm machine guns reduced speed, nevertheless, they contribute to the distinctive personality of the Bf 109. Too the bigger guns were heavier affecting performance.

**For accurate color reference we recommend the Luftwaffe Color Chart published by Eagle Editions Ltd. featuring paint chips prepared by Warnecke and Böhm available from your local hobby shop or Eagle Editions Ltd.**

**Resin EagleParts for the Bf 109: EP#20-32 Corrected spinner for the Hasegawa "G" series  
EP#21-32 Corrected drop tank for the Hasegawa "G" series  
EP#22-32 Battery Box for G-6 and G-14  
EP#23-32 Corrected ETC rack for drop tanks**

**"Yellow 1"**                      **Bf 109 G-6 Trop**                      **12.JG 27**                      **Summer 1943**                      **Tanagra, Greece**  
*Staffelkapitän* Oblt. Dietrich Boesler's Bf 109 G-6 was equipped at times with MG 151, 20 mm cannon underwing gondolas. Note the Yellow circle with Black trim and *Staffelkapitän's* pennant mounted on antenna mast. *Werknummer* unknown, overpainted. This G-6 Trop appears to have an extra shield over the exhaust to keep exhaust gasses from the tropical filter. FuG 25 a antenna mast installed.  
**Colors:** Undersurfaces, 76 Light Blue; Uppersurfaces 75 Gray-Violet/74 Gray-Green. White underwing tips and 04 Yellow undercowling  
 Note JG 27 emblem appears to be oversprayed on port side of engine cowling. White fuselage band; IV./JG 27 was utilizing the double bar IV. *Gruppe* marking at this time, in this case the *Staffel* color, 04 Yellow.  
 Spinner: White with Black spiral. Prop Blades: 70 Black-Green.  
 For pennant, cut a circle in card stock or thin plastic, after painting it Black, use our supplied decal, U.

**National Markings:** 900 mm Black with White outlined fuselage crosses. Black with White outline *Hakenkreuz*  
 Wings: Upper - 1000 mm White outline crosses Lower - 900 mm Black with White outline crosses .

**Stencilling:** Factory standard. Note Red cross marking on port side of fuselage cross.

**Reference:** Prien, Rodeike, Stemmer; **Messerschmitt Bf 109 in Einsatz bei der III. and IV./JG 27.** Struve Druck, Germany page 378.

**"White 3"**                      **Bf 109 G-6 Trop**                      **Pilot: Uffz. Franz Stadler**                      **7./JG 27**                      **April 1944**                      **Crete**  
 Features include tall antenna mast, underwing 20 mm cannon gondolas, no umbrella holders, DF loop, FuG 25 a antenna intact, solid headrest and overhead armor in canopy. Tropical filter and unusual gun camera on leading edge of port wing (see photo). Note vertical White bar tilted. II./JG 27 emblem both sides of aircraft. Cockpit fresh air scoop removed and faired over.  
**Colors:** Undersurfaces, 76 Light Blue; Uppersurfaces 75 Gray-Violet/74 Gray-Green. Note large spots of mottling 74 circled with 76 (see Photo). Upper camouflage line along fuselage in line with canopy. Yellow undercowling, White fuselage band, filler panel light. Spinner; 2/3 RLM 70 Black Green, 1/3 White. Prop blades RLM 70 Black-Green.

**National Markings:** Oversized White outlined fuselage crosses. White outline *Hakenkreuz*  
 Wings: Upper -1000 mm White outline crosses Lower - 900 mm Black/White with Black outline crosses.

**Stencilling:** Factory standard

**Reference:** Photos printed on instructions

**"White 8"**                      **Bf 109 G-6 Trop**                      **W. Nr. 15508**                      **7./JG 27**                      **December 1943**                      **Crete**  
 Features of this aircraft include underwing 20 mm cannon, solid head rest and overhead armor, umbrella holders intact. Tropical filter, tall antenna mast, no DF loop or base and FuG 25 a intact (provisional)  
**Colors:** Undersurfaces, 76 Light Blue; Uppersurfaces 75 Gray-Violet/74 Gray-Green. Unusual upper surface camouflage along upper portion of fuselage in line with canopy. Heavy mottling of 74/75. Possible Yellow undercowling, White fuselage band.  
 Spinner: 2/3 RLM 70 Black Green, 1/3 White. Prop blades RLM 70 Black-Green. Note upper wing camo pattern.

**National Markings:** 900 mm White outline fuselage crosses. White outline *Hakenkreuz*  
 Wings: Upper - 1000 mm White outline crosses Lower - 900 mm Black/White with Black outline crosses.  
 II./JG 27 emblem on both sides of cowling. 7. Staffel emblem under cockpit, port side only.

**Stencilling:** Factory standard

**Reference:** Prien, Rodeike, Stemmer, **III and IV JG 27**, page 256, 257.

**"Yellow 13"**                      **Bf 109 G-6 Trop**                      **II./JG 51**                      **April 1943**                      **Tunisia**  
 Notable features include tropical filter, tall antenna mast, no DF loop or base, FuG 25 a intact (provisional) and solid headrest with overhead armor. Umbrella holders intact. Note replaced fin tip, see photo. Photo does not show 20 mm underwing gondolas but they could have been installed at various times.  
**Colors:** Undersurfaces, 76 Light Blue; Uppersurfaces 75 Gray-Violet/74 Gray-Green. Yellow undercowling, White fuselage band with White bar in front of Yellow 13. Spinner: White. Prop blades RLM 70 Black-Green  
**National Markings:** 900 mm Black/White crosses. Black/White *Hakenkreuz*. Note two different sizes due to replaced fin tip.  
 Wings: Upper - 1000 mm White outline crosses Lower - 900 mm Black/White provisional crosses.  
**Stencilling:** Factory standard, note spot of RLM 75 over painting on unit emblem.

**Reference:** Photo printed on instructions

© 2002 Eagle Editions Ltd. All images/photos copyrighted by

Eagle Editions Ltd. P.O. Box 580 Hamilton MT 59840

1-800-255-1830 orders (406) 375-9270 Fax or (406) 363-5415 office

No copies may be reproduced without written consent from publisher Eagle Editions Ltd.

The color schemes depicted are the artist's interpretations of the available photographic references only. The final decision resides with the modeler.



“White 3” of Uffz. Frans Stadler 7./JG 27, with unusual camouflage pattern of RLM 75/RLM 74. The underwing cannons are visible. White 1/3 segment on the spinner is barely visible.



Close-up showing this unusual large spots of RLM 74/RLM 75 and the fuselage. The slightly larger than standard (900 mm) White outline fuselage cross is interesting.

Another view of the cockpit area illustrating the large spots and the unusual number ‘3’. Note the flares around Stadler’s waist.



continued on next page

NOTE: Stencil diagram drawings are representational only. Check your references for the specific details and differences between variants.

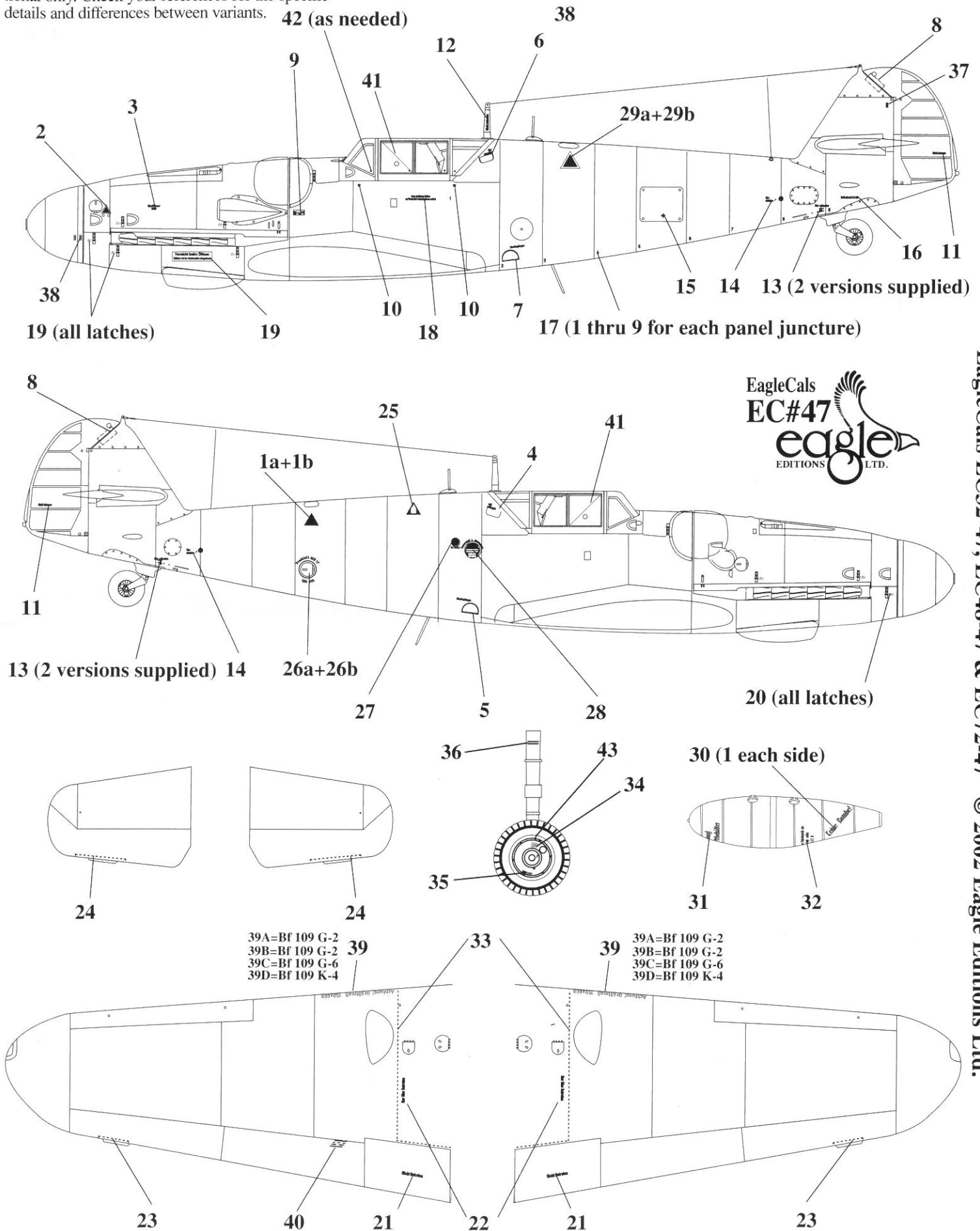



The tropical filter and lack of umbrella holders can be seen. Note the factory data plate. The gun camera aperture on the port wing is capped over.

## “Yellow 13” II./JG 51



“Yellow 13”, G-6 trop of II./JG 51 now in American custody. The tropical filter and umbrella holders are clear. Note the White II. *Gruppe* bar in front of the number ‘13’ typical of II. *Gruppe* JG 51. No DF loop antenna or base. JG 51 Hawk’s head emblem may have been painted over on the port cowl. The fin tip has been replaced from another aircraft with a different sized *Hakenkreuz*. No 20 mm cannon gondolas installed in this image but were used at times as profile illustrates.

Courtesy Fort Missoula Military Museum

# Bf 109 G 6 Tropf

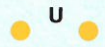
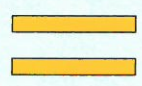
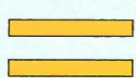
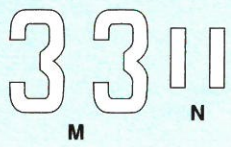
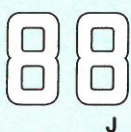
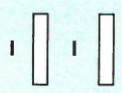

A

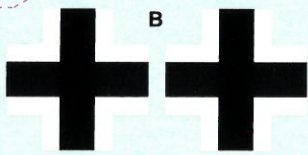

D

B

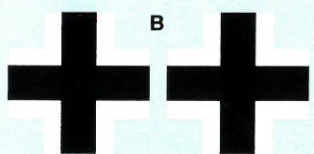

D

D

A



C

B

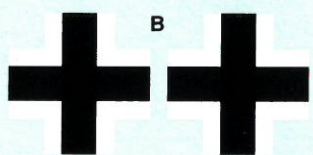

1a	1a	1a	1b	1b	1b	2	2	3	4	5	6	7	8	9				
10	11	12	13	13	14	15	16	17	17	17	17	17	26a	26b	27	28		
18	19	20	21	21	22	23	24	25	25	25	25	25	29a	29a	29a	29b	29b	29b
37	38	39A	39B	39B	39C	39C	39C	39C	39C	39C	39C	39C	39C	39C	39C	39C	39C	39C
39D	40	41	41	41	41	41	41	41	41	41	41	41	41	41	41	41	41	41
31	32	32	32	32	32	32	32	32	32	32	32	32	32	32	32	32	32	32



E2 E1 E2 E1 F1 F2 F1 F2 G G