

? 選擇 (Select)

! 鑽孔 (Make hole)

■ 填充部分切除 (Cut the Shadow)

○ 蝕刻零件號 (PE Part No.)

🖱️ 水貼紙 (Decals)

↗️ 折彎 (Sharp Bend)

📐 卷曲 (Ro11)

➡️ 替換原零件 (Replace Original Part)

↔️ 另一側相同制作 (Same another side)

□ 原零件號 (Original Part No.)

👤 樹脂零件 (RESIN PART)

**1** 一号炮塔 (First Turret)  
三号炮塔 (Third Turret)  
五号炮塔 (Fifth Turret)

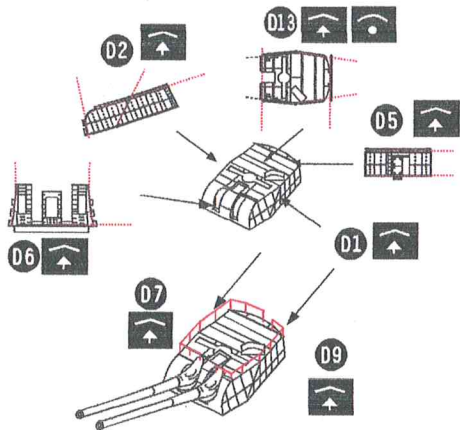

建議:制作順序  
Advice:Production order D6 D5 D1 D2 D13

二号炮塔 (Second Turret)  
四号炮塔 (Fourth Turret)

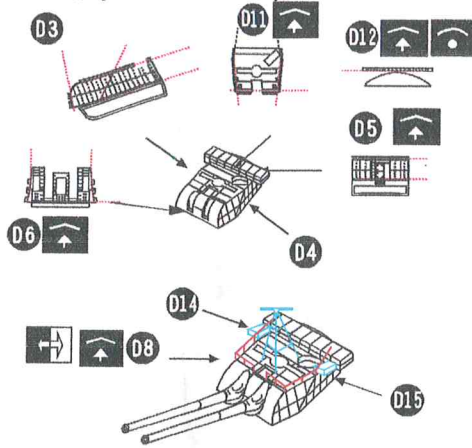

建議:制作順序  
Advice:Production order D6 D5 D3 D4 D13

20.3公分50倍徑主砲  
20.3cm 50Cal Main Gun

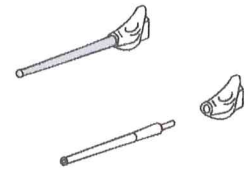

3rd Year Type Metal Barrel

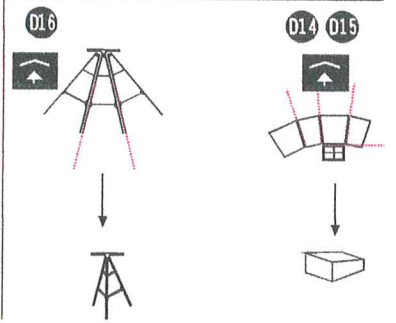

**2** B6 B7 B9 B10

E6 E10 E21  
E7 E18 E22  
E9 E19 E23 E24

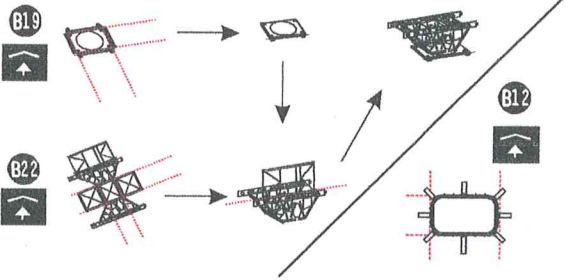
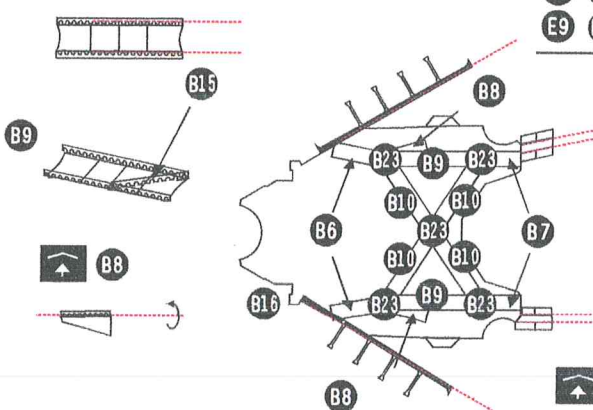

MITSUBISHI F1M2 'PETE' 1942-1945

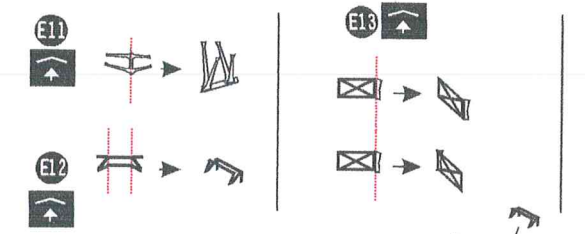

Aichi E13A1 'JAKE' 1942-1945

