

AeroMasterTM

PRODUCTS

IGG 1 Butcher Birds Pt. XI

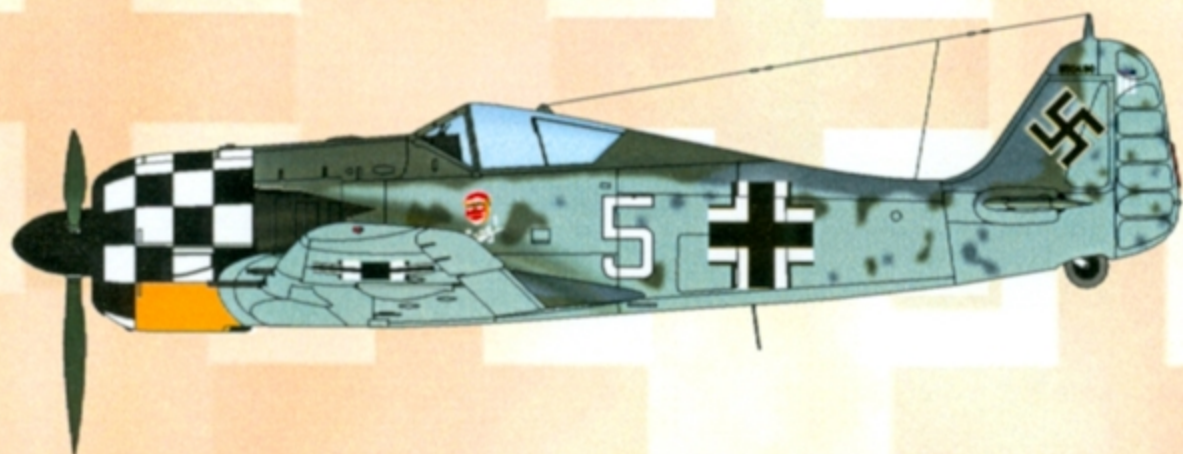

Suggested Kit: Tamiya Fw-190

Butcher Birds

Pt. XI

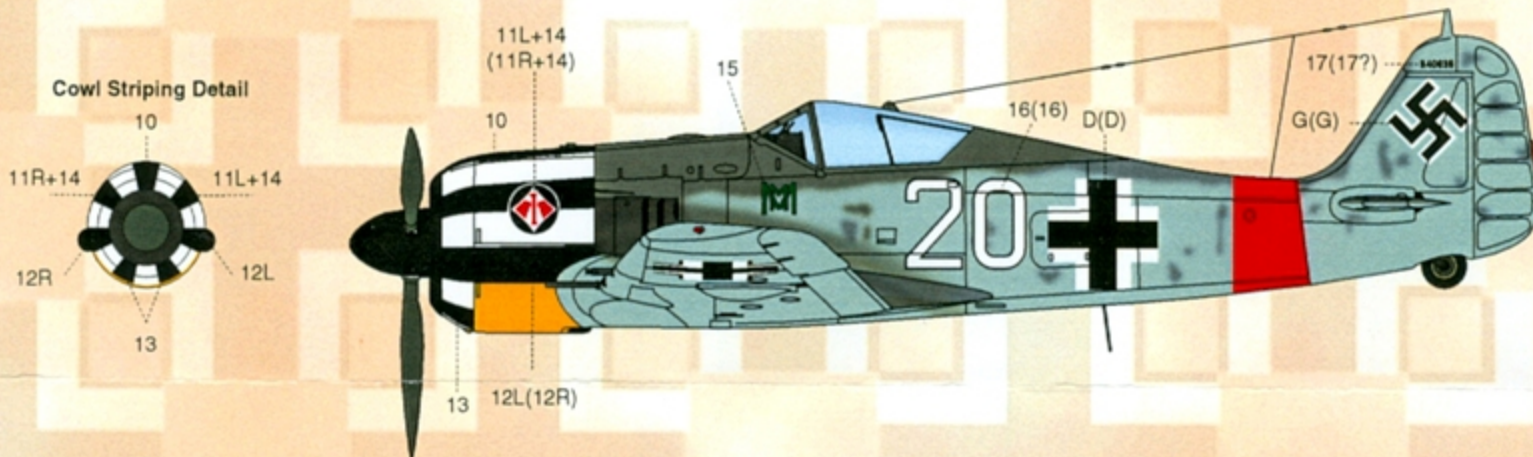
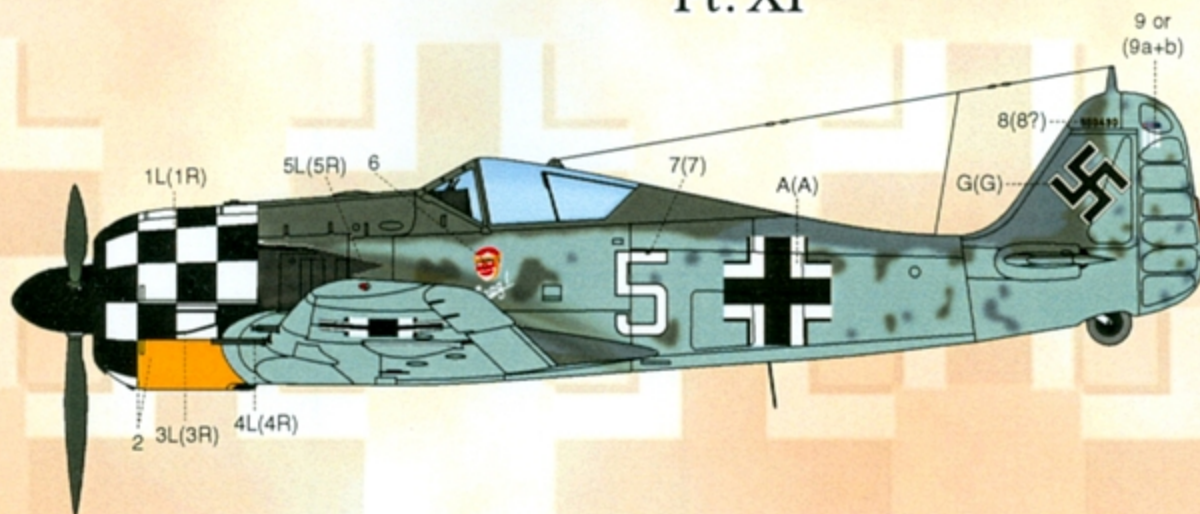

Cowl Striping Detail

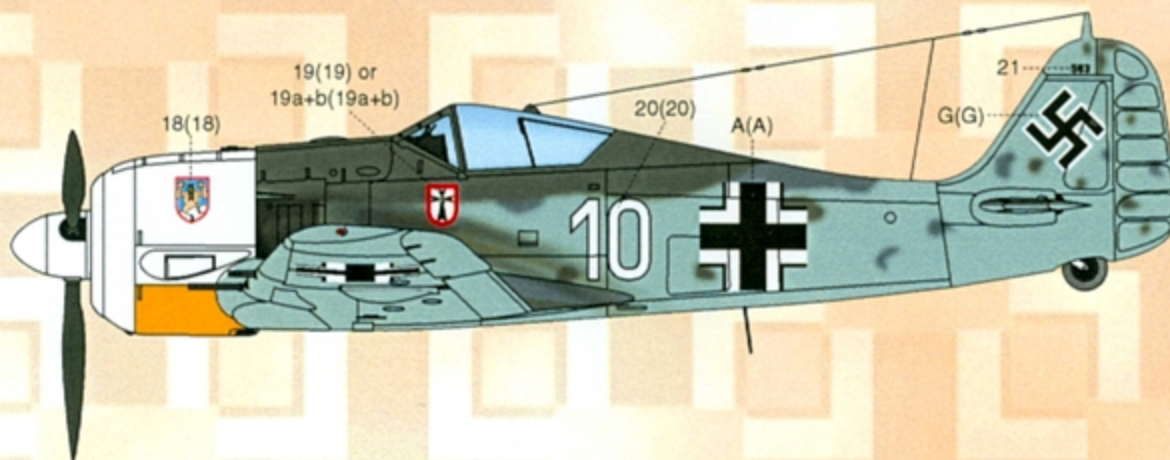
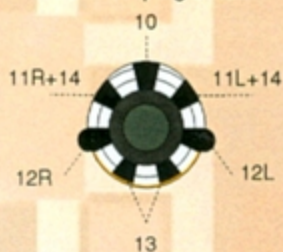

White 5, the mount of Uffz. Rudolf Hübl, of I/JG 1 was an Fw-190A-6. It was destroyed after combat with US B-17's. Wearing standard RLM 74/75/76 camouflage colors, this colorful A/C had a checkerboard cowling with Yellow undersurfaces and Black spinner/cowl ring combination. The serial number was 550490 and it had Hübl's personal markings depicting the famous prewar German comedian "Grog".

White 20, Fw-190A-7, W.Nr 340035. Major Emil Rudolf Schnoor flew this A/C to achieve 23 victories. This machine was belly landed near Detmold on April 16, 1944. Wearing the same camouflage as A/C 1, it had stripes rather than checkers on the front cowling. Schnoor was the Gruppen-Kommandeur of I/JG 1 during March/April 1944. His personal markings, a double M, refers to his wife. He still shows it today on his car!

White 10, an early Fw-190A-4, W.Nr 583, was flown by Ofw Fritz Husser of I/JG 1. This A/C was lost on July 8, 1943, also fighting B-17's. It is camouflaged as A/C 1, but without the checkers.

RLM 04	RLM 74	RLM 75	RLM 76
FS 33538	FS 34086	FS 36122	FS 36473

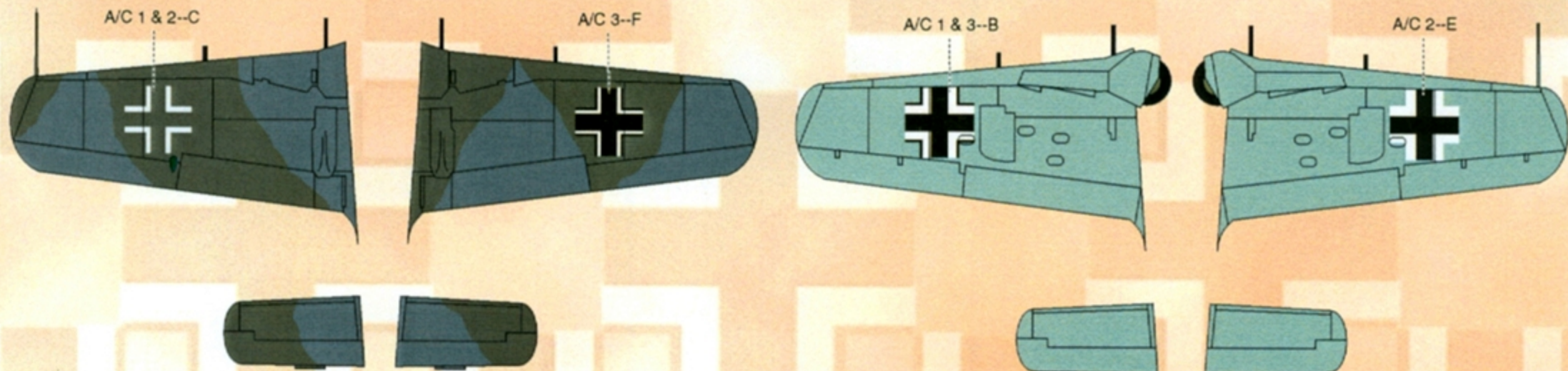

Suggested 1:48 Scale Kits:

Tamiya Fw-190 Family
Hasegawa/DML Fw-190 Family

References:

1. Luftwaffe Aces in WWII, Green Arrow, Japan, 1992
2. Sundin, C & Bergstrom, C: Luftwaffe Fighter Aircraft in Profile, Schieffer, 1997
3. Nohara, S: Luftwaffe Camouflage & Markings Vol. 1 Day Fighters, Model Art
4. Weal, J: Fw190 Aces of the Western Front, Osprey, 1996
5. Revi magazines have also been used.

Decaling the checkered cowlings:

1. Paint White and Yellow area of the cowling White. Mask of the White area and paint the lower panel Yellow (RLM 04). Finish your paint job, remove all the masking. Gloss over the entire area.
2. Now you are ready for decaling. Apply decals 1L and 1R, carefully aligning them with the panel/hinge line above the cowl side blister. Your top checks will fit perfectly overlapping each other.
3. Next apply 3L and 3R, edging the forward portion of the blister. Align the top and bottom section to completely enclose the forward part of the blister.
4. Repeat the same procedure with parts 4L and 4R, but at the rear of the blister. At this time your cowl blister should be enclosed by parts 3L and 11L and 3R and 11R.
5. Apply the three parts #2 on the lower cowl ring, spacing them evenly. Allow to dry. Wash your model.
6. With a fine brush, Black paint and a steady hand, fill in the blisters front and rear checks.
7. Finish decaling your model. These checks have been measured to perfectly fit the Tamiya kit. Happy Modeling.

AeroMaster Warbird Colors		Enamels	
9001	Black	9012	Flat Clear
9002	White	9013	Semi-Gls Clr
9003	Yellow	9014	Gloss Clear
9004	Blue	1025	RLM 74 Graugrün
9005	Red	1026	RLM 75 Grauviolett
9010	Tire Black	1027	RLM 76 Lichtblau
9011	Glaze		

AeroMaster Warbird Colors		Acrylics	
1001	Gloss Clear	1014	RLM 23 Red
1002	Semi-Gls Clr	1015	RLM 24 Blue
1003	Flat Clear	1016	RLM 25 Green
1004	Tire Black	1025	RLM 74 Graugrün
1011	RLM 04 Yellow	1026	RLM 75 Grauviolett
1012	RLM 21 White	1027	RLM 76 Lichtblau
1013	RLM 22 Black		

Aeromaster Decals™

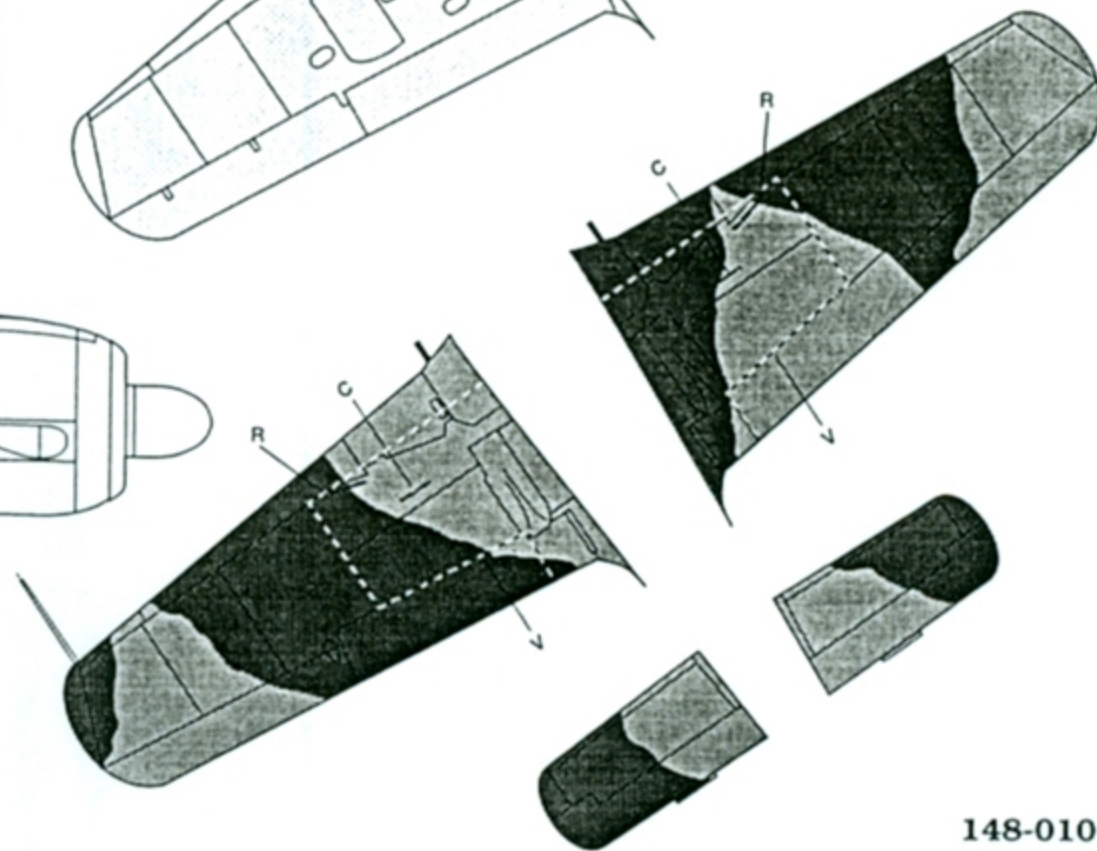
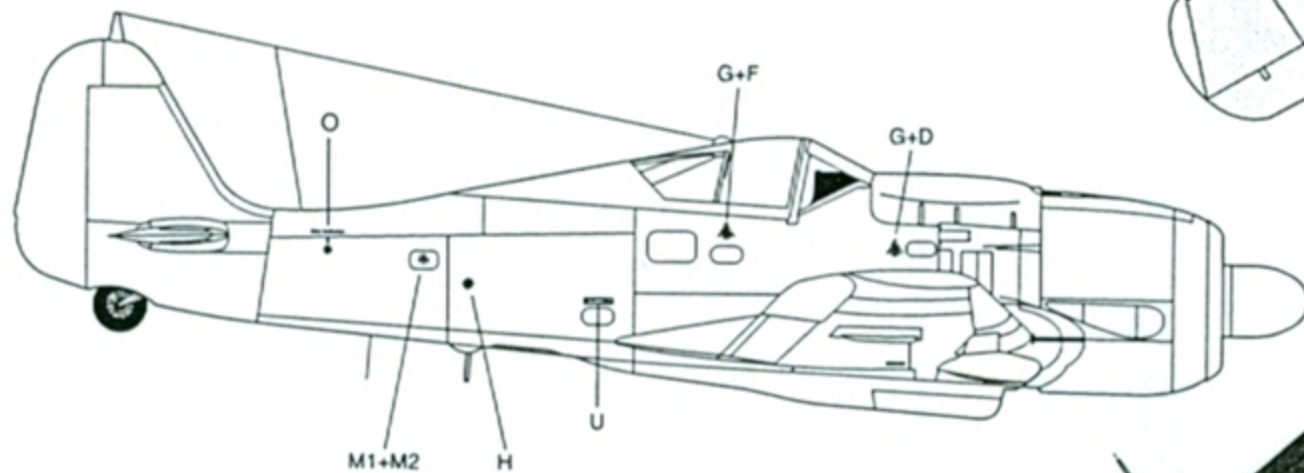
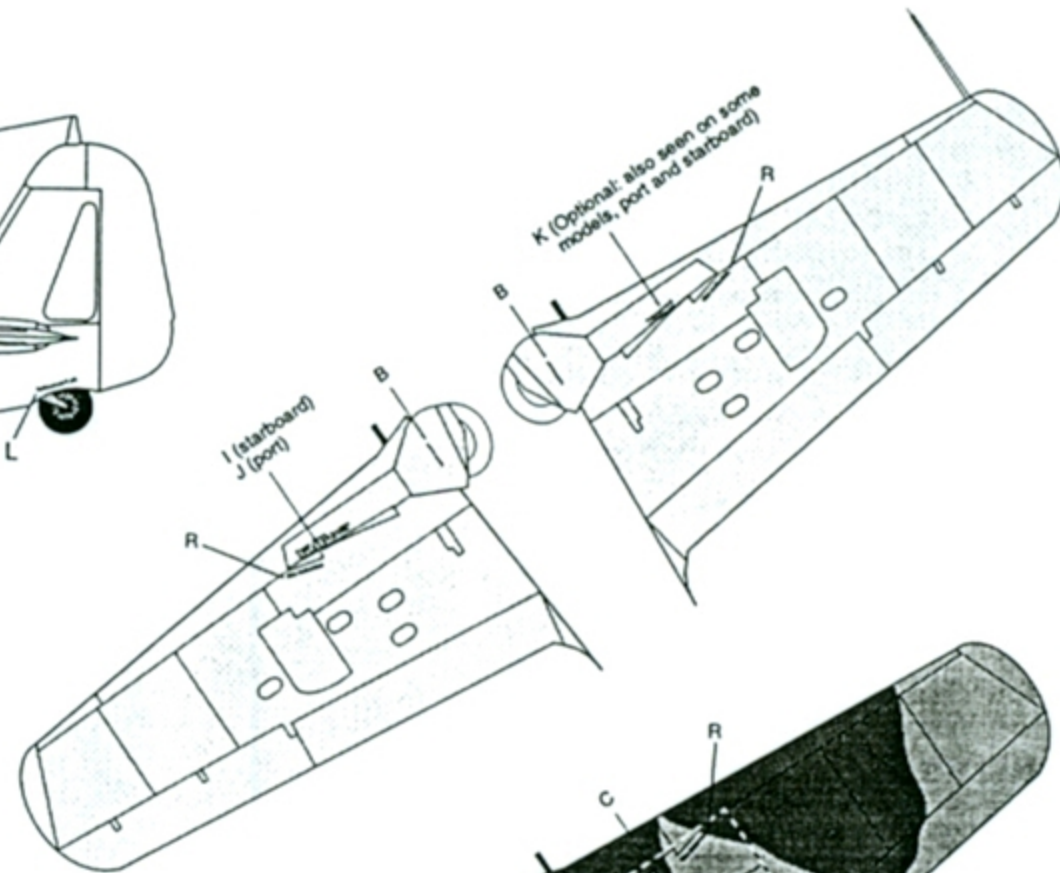
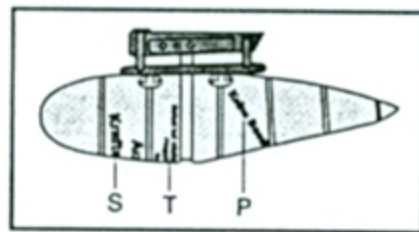
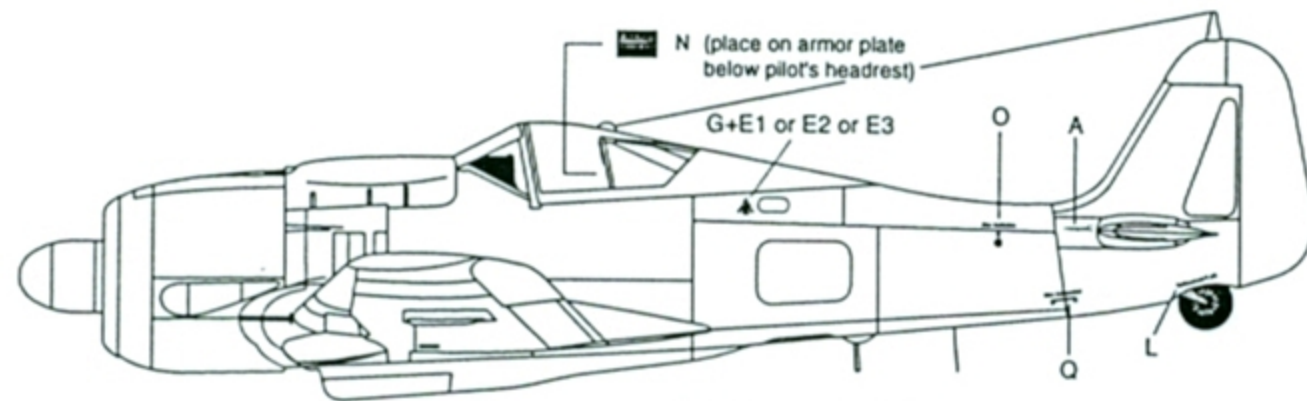

Fw-190
GENERAL STENCIL PLACEMENT &
CAMOUFLAGE PATTERN