

Decal Art. 72/510 - 72/554

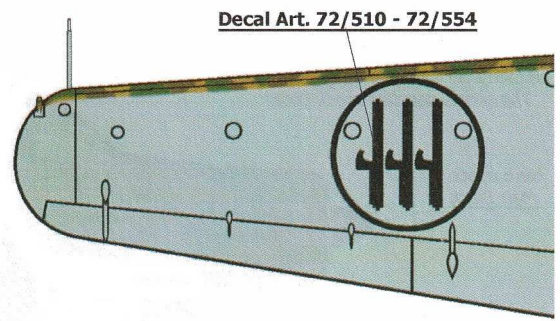

Decal Art. 72/510 - 72/554

SAVOIA MARCHETTI SM 79 MM 23881
278ª Sq.Aut. Aerosiluranti
(Berka-Bengasi 1941)

Pil. Cap. O.Cimolini, M.Ilo C. Barro, Srg. Magg. A. De Luca,
Av. Q. Jonello, Av. G. Romanini, St. V. F. Franchi

Grigio Azzurro Chiaro
Light grey Fs 36307

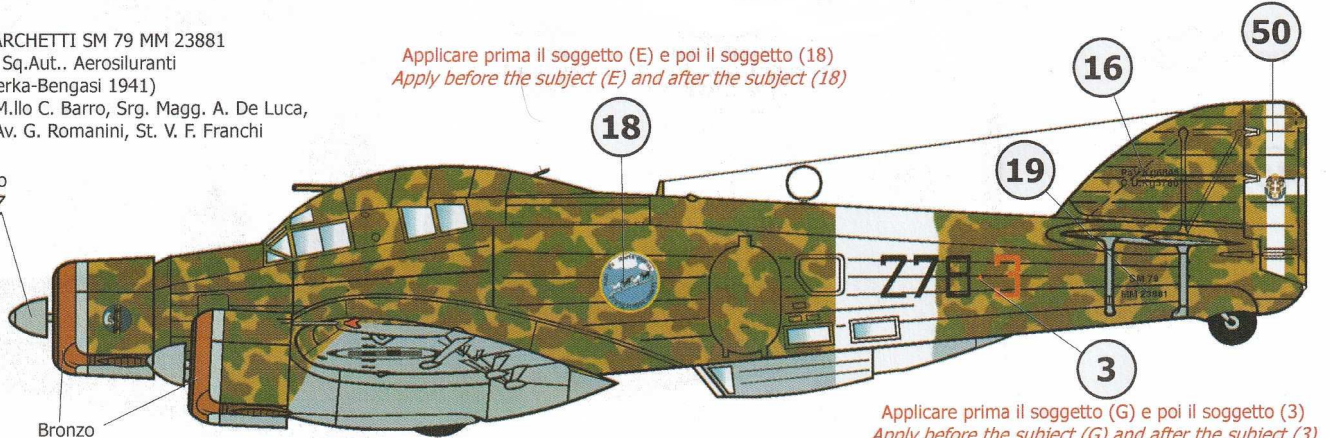

Applicare prima il soggetto (E) e poi il soggetto (18)
Apply before the subject (E) and after the subject (18)

Applicare prima il soggetto (G) e poi il soggetto (3)
Apply before the subject (G) and after the subject (3)

Giallo Cromo 7
Yellow Fs 13655

Bronzo
Bronze

Nero Opaco
Matt Black Fs 37038

Superfici superiori: fondo Giallo Mimetic 3, macchie Verde 53192 e Marrone 53193.
Superfici inferiori: Grigio Azzurro Chiaro 1
Upper surface: Green Fs 34227 and Brown Fs 30140 on Yellow Ocre Fs 33434
Under surface: Light Grey Fs 36307

Superfici superiori: fondo Verde Oliva Scuro 2, macchie Grigio Azzurro Chiaro 1 più diffuse sulla parte anteriore
Superfici inferiori: Grigio Azzurro Chiaro 1
Upper surface: Light Grey Fs 36307 on Olive Green Fs 34052
Under surface: Light Grey Fs 36307

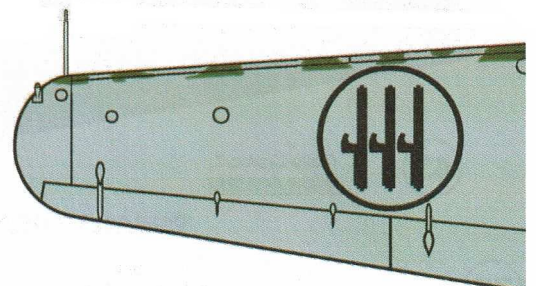
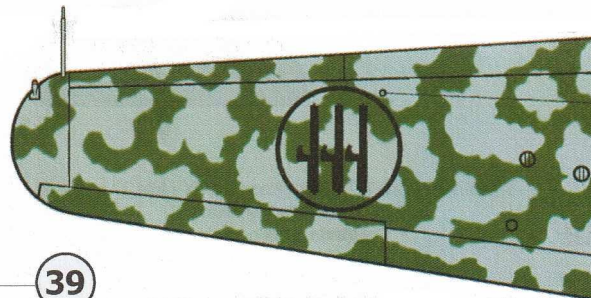
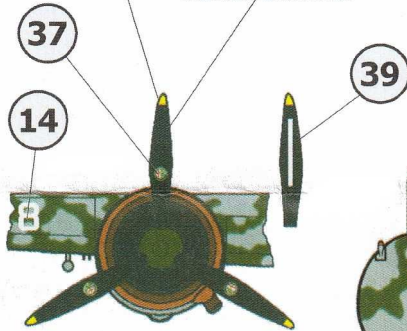

SAVOIA MARCHETTI SM 79 - MM ??
253ª Sq., 104ª Gr. Aerosiluranti
(Gadurrà Rodi 1942)

Le matricole fornite sono di fantasia
The serials supplied are fictional

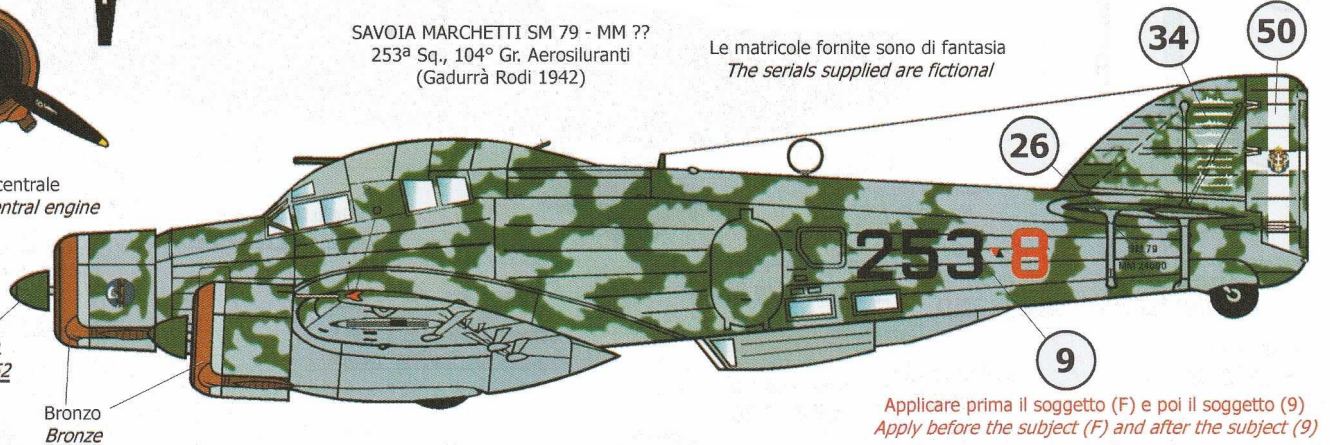
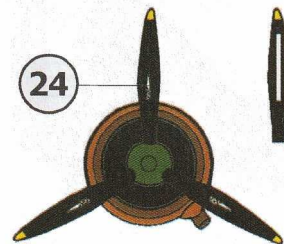

Applicare prima il soggetto (F) e poi il soggetto (9)
Apply before the subject (F) and after the subject (9)

Verde Oliva Scuro 2
Olive Green Fs 34052

Bronzo
Bronze

Elica motore centrale
propeller of the central engine



PRONTO MODEL
di De Paoli Walter

TAURO MODEL DECAL LINE

Via SAN DOMENICO 16 - 10022 CARMAGNOLA (TO) ITALY
<http://www.tauromodel.it>
<http://www.prontomodel.com>

E Mail: info@prontomodel.com

DECAL ART. N° 72/535
Regia Aeronautica
National Insigna - 1/72

Utilizzabili per i seguenti modelli: *Suitable for the following model kits:*

CR 32: Supermodel, Italeri
CR 42: Revell, Matchbox, Italeri, Pavla. SM 79: Italeri, Airfix
SM 81: Italeri, Supermodel



DRAWINGS: DE PAOLI ANTONIO E VALTER - RIPRODUZIONE FOTOMECCANICA, ELETTRONICA E MANUALE DEI PROFILI E DELLE DECALCOMANIE, ANCHE PARZIALE, VIETATA
No part of this item can be reproduced by electronic, mechanical, photocopying, recording or otherwise, without prior permission of Pronto Model.

SAVOIA MARCHETTI SM 79 - MM ??
101° Stormo B. V.
(Spagna 1938)

Le matricole fornite sono di fantasia
The serials supplied are fictional

Nero opaco
Matt Black

Azzurro Chiaro
Light Blue Fs 15450

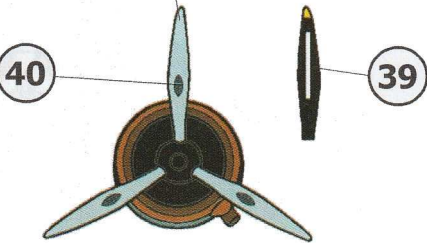

40

39

Applicare prima il soggetto (C) e poi il soggetto (42)
Apply before the subject (C) and after the subject (42)

42

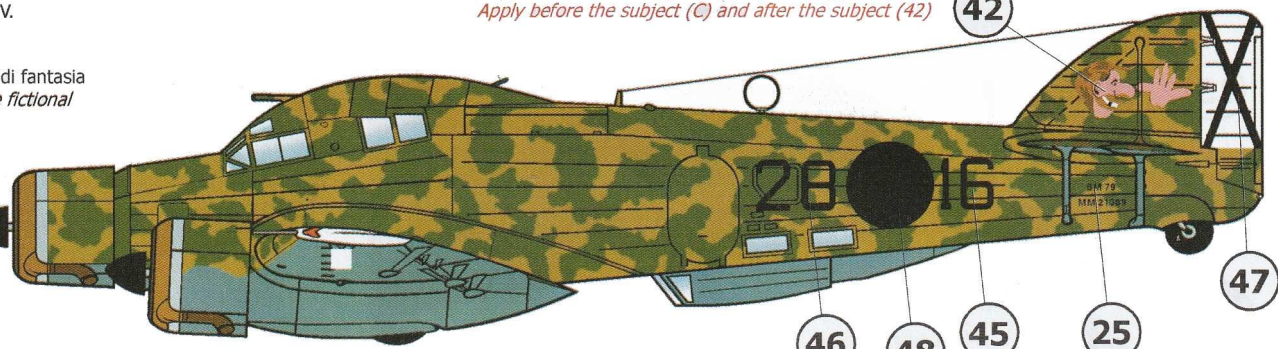

Superfici superiori: fondo Giallo Mimetico 3, macchie Verde Mimetico 1
Superfici inferiori: Grigio Mimetico.
Upper surface: Green Fs 34258 on Yellow Ocre Fs 33434
Under surface: Mimetic Grey Fs 36293

46

48

45

25

47

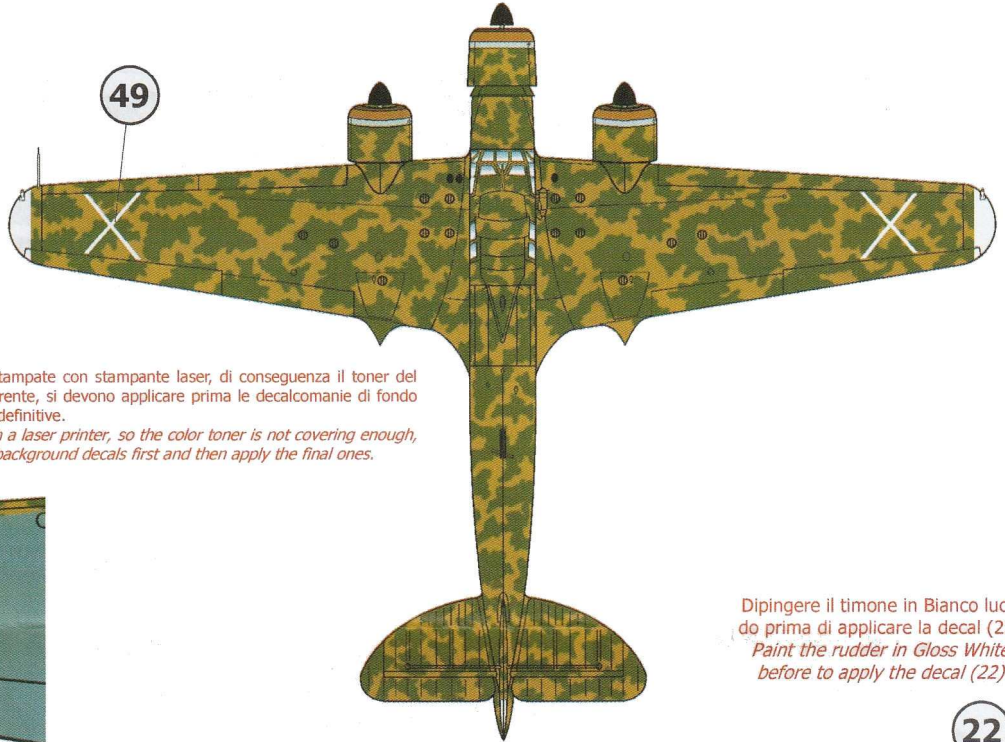

49

Queste decalcomanie sono stampate con stampante laser, di conseguenza il toner del colore non è abbastanza coprente, si devono applicare prima le decalcomanie di fondo bianco e poi applicare quelle definitive.
These decals are printed with a laser printer, so the color toner is not covering enough, you have to apply the white background decals first and then apply the final ones.

44

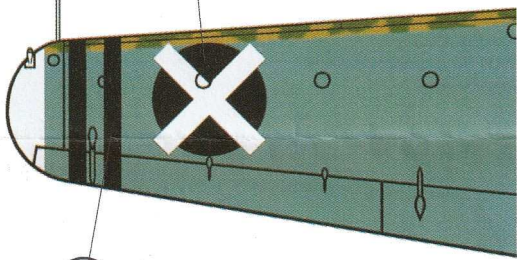

Dipingere il timone in Bianco lucido prima di applicare la decal (22)
Paint the rudder in Gloss White before to apply the decal (22)

43

Giallo Cromo 7
Yellow Fs 23655

Decal Art. 72/510-72/554

SAVOIA MARCHETTI SM 81 Piaggio P IX - MM ??
Scuola Volo Senza Visibilità.
(Littoria 1939)

22

38

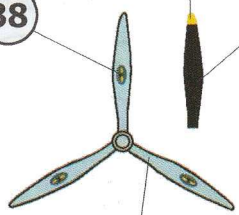

Nero Opaco
Matt Black Fs 37038

Marrone Mimetico 2
Brown Fs 10076

Giallo Mimetico 3
Yellow Ocre Fs 33434

12

10

Le matricole fornite sono di fantasia
The serials supplied are fictional

Azzurro Chiaro
Light Blue Fs 15450

Giallo Cromo 7
Yellow Fs 23655

Grigio Mimetico
Mimetic Grey Fs 36293

Decal Art. 72/510-72/554

Colorazione Bianco Avorio 5
Ivory White Fs 33613 painted

Decal Art. 72/510-72/554

Metallo naturale
Natural metal

Lato posteriore
Rear side

Metallo naturale
Natural metal

Nero Opaco
Matt Black Fs 37038

Rosso 8
Red Fs 11105

Le matricole fornite sono di fantasia
The serials supplied are fictional

1

8

Decal Art. 72/510-72/554

SAVOIA MARCHETTI SM 81 Piaggio P IX
62ª Sq., 29° Gr., 9° St. B.T.
(Gura-Etiopia 1935-36)

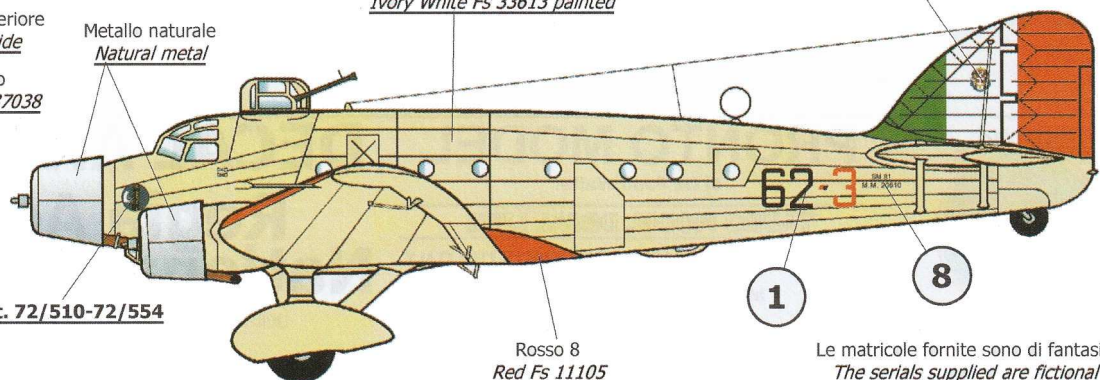

FIAT CR 42 MM 4326
85ª Sq., 18° Gr., 56° St. CT
(Maldegem-Belgio 1940)

Azzurro Chiaro
Light Blue Fs 15450

Giallo Cromo 7
Yellow Fs 13655

Nero Opaco
Matt Black Fs 37038

36

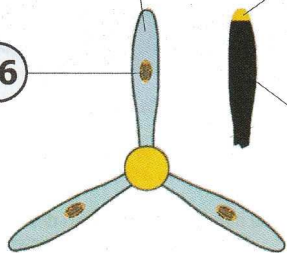

Giallo Cromo 7
Yellow Fs 13655

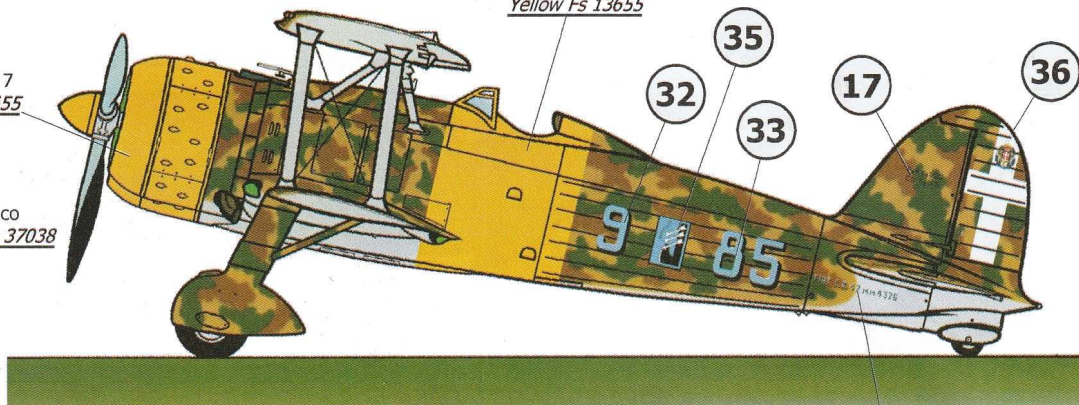

Per le insegne nazionali (Fasce) usare l'art. 72/503
For national insignias (fasces) use the item 72/503

29

FIAT CR 42 MM 5701
95ª Sq., 18° Gr., 56° St. CT (Maldegem-Belgio 1940)
Pil. Serg. Pietro Salvatori

Azzurro Chiaro
Light Blue Fs 15450

Giallo Cromo 7
Yellow Fs 13655

Nero Opaco
Matt Black Fs 37038

Bianco Neve 6
White Fs 137886

36

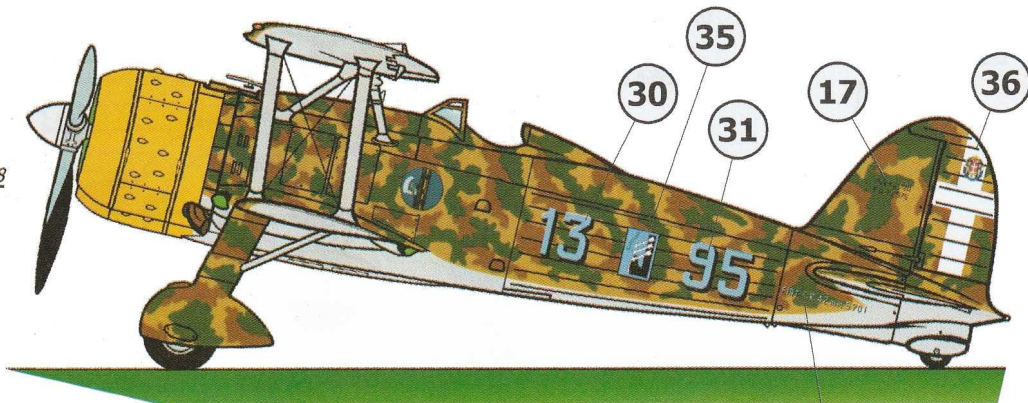
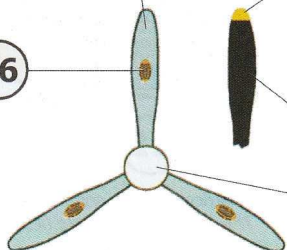

Superfici superiori: fondo Giallo Mimetico 3, macchie Verde Mimetico 3 e Marrone Mimetico 2
Superfici inferiori: Alluminio
Upper surface: Green Fs 34102 and Brown Fs 10076 on Yellow Ocre Fs 33434
Under surface: Matt Silver

Per le insegne nazionali (Fasce) usare l'art. 72/503
For national insignias (fasces) use the item 72/503

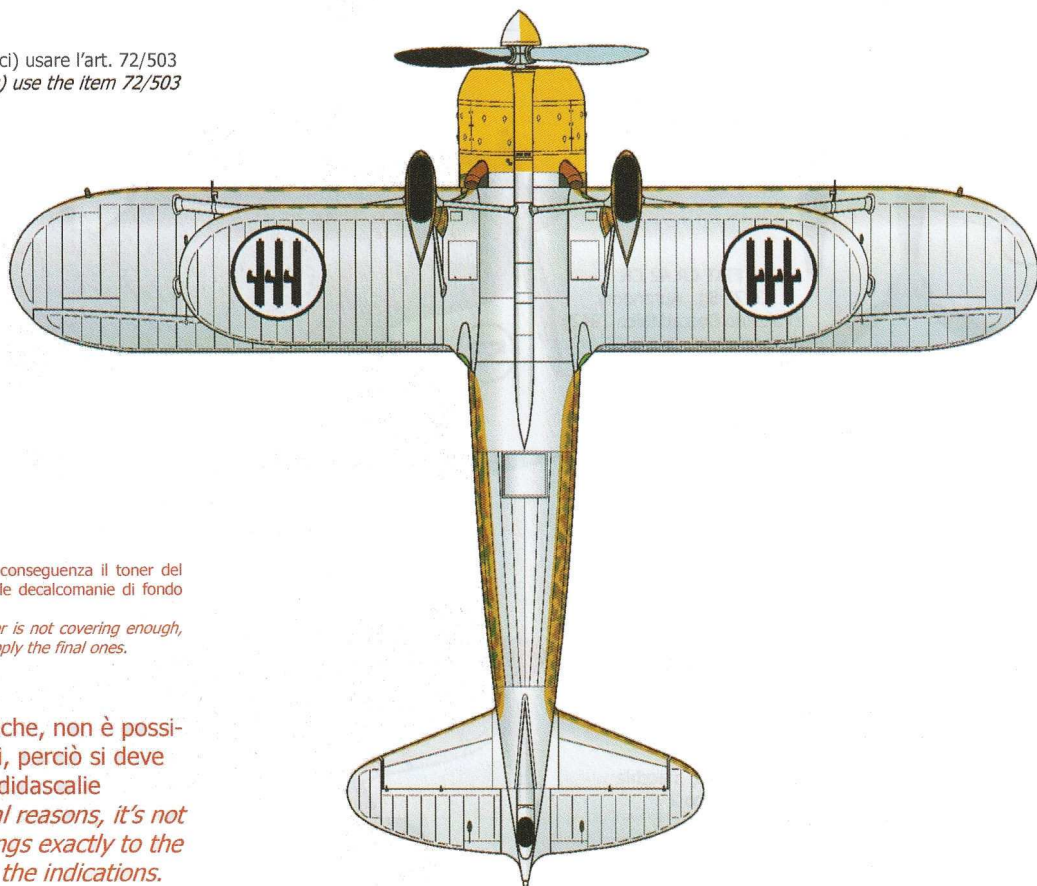

Queste decalcomanie sono stampate con stampante laser, di conseguenza il toner del colore non è abbastanza coprente, si devono applicare prima le decalcomanie di fondo bianco e poi applicare quelle definitive.
These decals are printed with a laser printer, so the color toner is not covering enough, you have to apply the white background decals first and then apply the final ones.

Si avvisa il modellista che, per ragioni tecniche, non è possibile stampare i colori identici a quelli reali, perciò si deve tener conto dei colori indicati sulle didascalie
We advise the modellers that, for technical reasons, it's not possible to print the colours of the drawings exactly to the real colours, therefore, it's well to follow the indications.

Applicare prima il soggetto (B) e poi il soggetto (6)
Apply before the subject (B) and after the subject (6)

SAVOIA MARCHETTI SM 81 ALFA 125 - MM ??
214ª Sq., 52º Gr., 34º St. B.T.
(Catana Fontanarossa 1937)

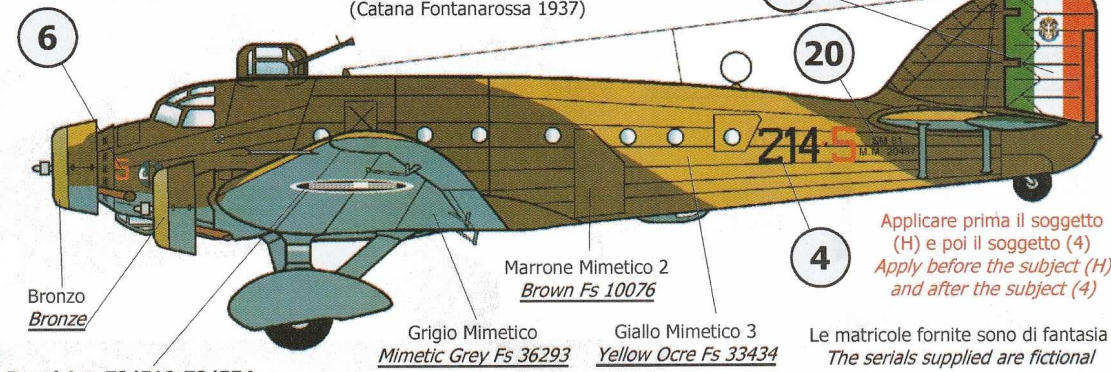
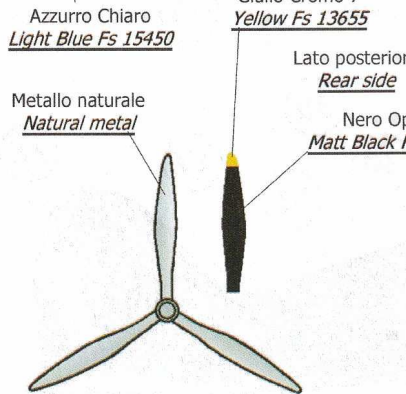
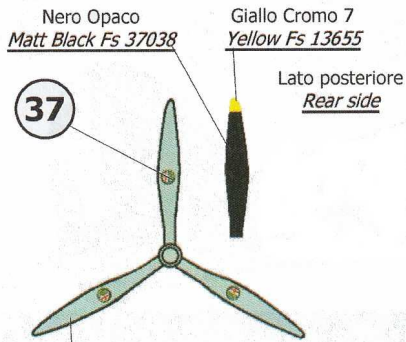

Decal Art. 72/510-72/554

Applicare prima il soggetto (H) e poi il soggetto (4)
Apply before the subject (H) and after the subject (4)

Le matricole fornite sono di fantasia
The serials supplied are fictional

SAVOIA MARCHETTI SM 81 ALFA 125 - MM ??
Unità sconosciuta.
Unknown unit

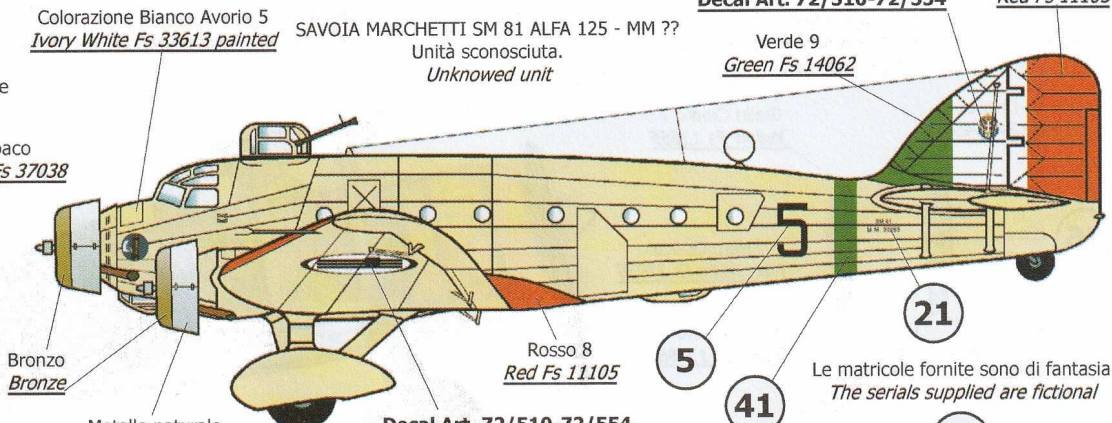

Decal Art. 72/510-72/554

Le matricole fornite sono di fantasia
The serials supplied are fictional

SAVOIA MARCHETTI SM 81 Gnome Rhône K 14 - MM ??
600ª Sq. Trasporto (Libia 1941)

Superfici superiori: fondo Giallo Mimetico 3, macchie
Marrone Mimetico 2
Superfici inferiori: Grigio Mimetico
Upper surface: Brown Fs 10076 on Yellow Ocre Fs 33434
Under surface: Mimetic Grey Fs 36293

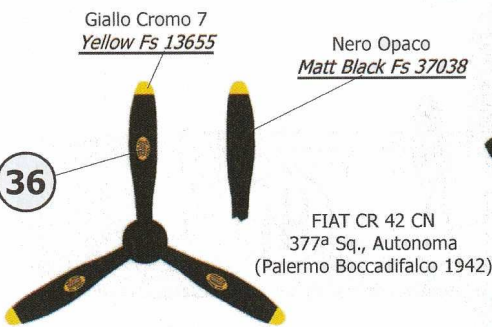

Il velivolo è verniciato completamente in Nero Fumo.
Aircraft is all in Matt Black.

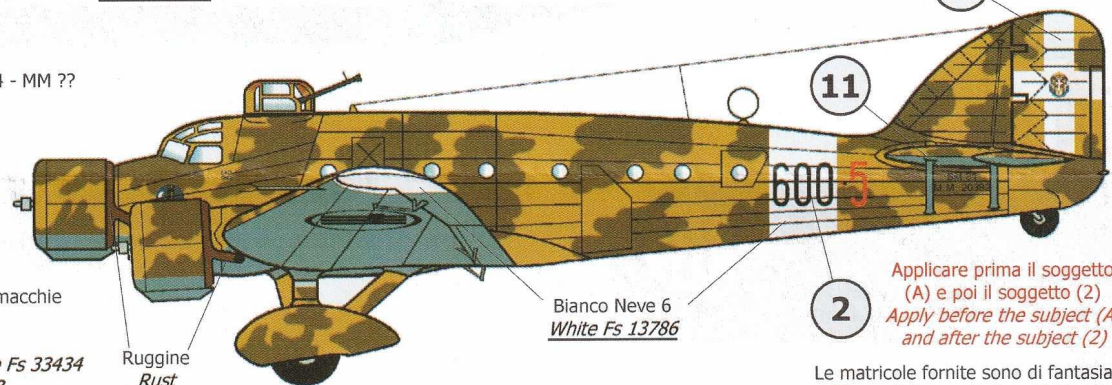

Applicare prima il soggetto (A) e poi il soggetto (2)
Apply before the subject (A) and after the subject (2)

Le matricole fornite sono di fantasia
The serials supplied are fictional

Applicare prima il soggetto (D) e poi il soggetto (7)
Apply before the subject (D) and after the subject (7)

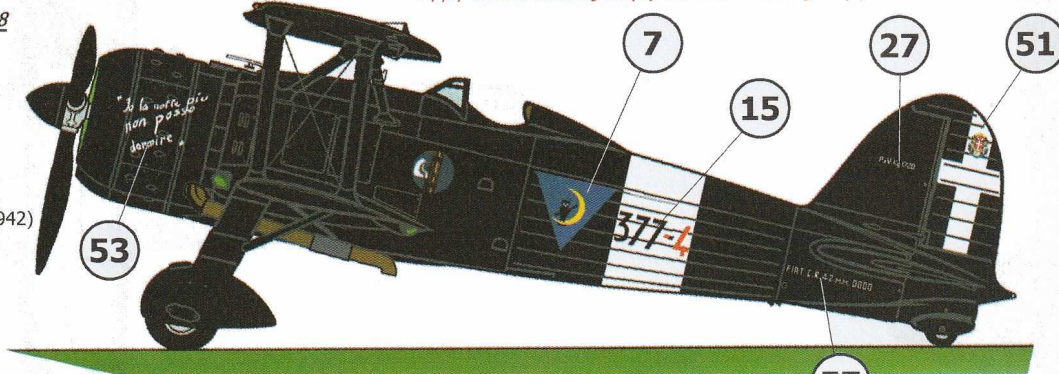

Le matricole fornite sono di fantasia
The serials supplied are fictional

FIAT CR 42 MM ??
83ª Sq., 18º Gr., 3º St. C.T. (Mondovì - May 1940)

Rosso 8
Red FS 31105

Per le insegne nazionali (Fasce) usare l'art. 72/503
For national insignias (fasces) use the item 72/503

Superfici superiori: fondo Giallo Mimetico 3, macchie
Verde Mimetico 3 e Marrone Mimetico 2
Superfici inferiori: Alluminio
Upper surface: Green Fs 34102 and Brown Fs 10076
on Yellow Ocre Fs 33434
Under surface: Matt Silver

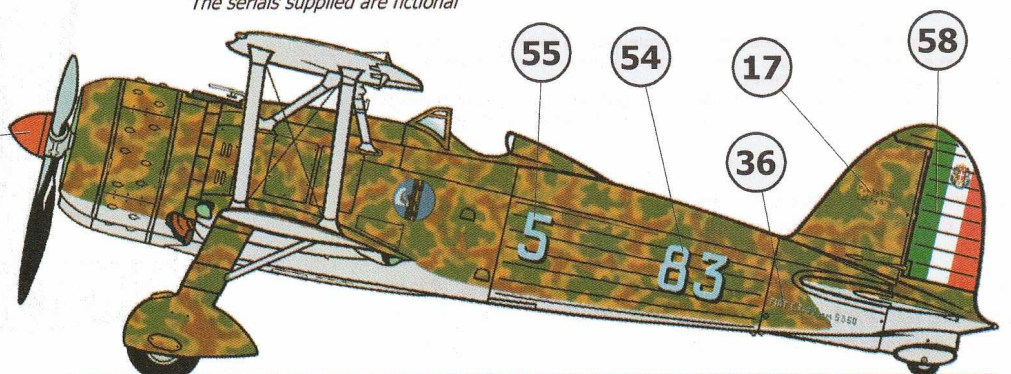

62-3¹ 62-3 600-5-5^A 5-5-600 5
 278-3³ 278-3 214-5⁴ 214-5⁵
 5 5 7 8 253-8⁹ 253-8

S.V.S.V.
 S.V.S.V.

377-4 15 377-4

P.Y. G. 6845 C.U. G. 3780

P.Y. G. 6845 C.U. G. 3780



P.Y. G. 6845 C.U. G. 3780

P.Y. G. 6845 C.U. G. 3780

P.Y. G. 1920 C.U. G. 379

P.Y. G. 1920 C.U. G. 379



P.Y. G. 1920 C.U. G. 379

P.Y. G. 1920 C.U. G. 379

F.M. G. 43 and 4333

F.M. G. 43 and 4333

F.M. G. 43 and 4333

F.M. G. 43 and 4333

F.M. G. 43 and 4333

F.M. G. 43 and 4333

F.M. G. 43 and 4333

F.M. G. 43 and 4333

F.M. G. 43 and 4333

F.M. G. 43 and 4333

F.M. G. 43 and 4333

F.M. G. 43 and 4333

F.M. G. 43 and 4333

F.M. G. 43 and 4333

F.M. G. 43 and 4333

F.M. G. 43 and 4333

F.M. G. 43 and 4333

F.M. G. 43 and 4333

F.M. G. 43 and 4333

F.M. G. 43 and 4333

F.M. G. 43 and 4333

F.M. G. 43 and 4333

F.M. G. 43 and 4333

F.M. G. 43 and 4333

F.M. G. 43 and 4333

F.M. G. 43 and 4333

F.M. G. 43 and 4333

F.M. G. 43 and 4333

F.M. G. 43 and 4333

F.M. G. 43 and 4333

F.M. G. 43 and 4333

F.M. G. 43 and 4333

F.M. G. 43 and 4333

F.M. G. 43 and 4333

F.M. G. 43 and 4333

F.M. G. 43 and 4333

F.M. G. 43 and 4333

F.M. G. 43 and 4333

F.M. G. 43 and 4333

F.M. G. 43 and 4333

F.M. G. 43 and 4333

F.M. G. 43 and 4333

F.M. G. 43 and 4333

F.M. G. 43 and 4333

F.M. G. 43 and 4333

F.M. G. 43 and 4333

F.M. G. 43 and 4333

F.M. G. 43 and 4333

F.M. G. 43 and 4333

F.M. G. 43 and 4333

F.M. G. 43 and 4333

F.M. G. 43 and 4333

TAURO MODEL DECAL LINE ART. 72/535 - SCALA 1/72
 REGIA AERONAUTICA INSIGNA - SM79, SM 81, Cr 42

II°0121

