

MONOGRAM®

Piper Tri-Pacer

SPORT PLANE

KIT NO. 6822



The name "Piper" has long been famous as one of the outstanding builders of sport planes. Today's Piper Tri-Pacer 150 is the latest in a long line of small planes designed for personal, sports or business use.

The Tri-Pacer is a four passenger monoplane, powered by a four-cylinder 150 h.p. Lycoming engine. It has a cruising speed of 123 m.p.h. and a service ceiling of 15,000 feet. It's wingspan is 29 feet, 4 inches and overall length is 20 feet, 7 inches. Additional baggage space is provided behind the seats, reached through an access door in the right side of the fuselage.

With its tricycle landing gear and excellent handling characteristics, the Tri-Pacer is said to be one of the easiest planes to fly. The deluxe interior is styled much like the interiors of modern automobiles,

with dual controls, individually adjustable front seats, ash trays, arm rests, cabin heater and ventilator, radio and complete instruments for all-weather flying.

ABOUT YOUR MODEL

Your Monogram model of the Piper Tri-Pacer is an accurate reproduction, scaled from actual factory blueprints supplied by the Piper Aircraft Corporation. It incorporates such deluxe features as working doors, fully detailed interior, removable cowling and realistic model Lycoming engine. Two sculptured figures are provided to add realism and scale proportion to your model. Since the Tri-pacer is a favorite of sportsmen all over the country, the figures are garbed in hunting clothes and equipment, and posed with a mountain lion trophy of the hunt.

ABOUT THE CIVIL AIR PATROL

The Civil Air Patrol is a civilian auxiliary of the United States Air Force. CAP was established in the Office of Civilian Defense in 1941 to organize and direct the activities of volunteer civilian airmen who made their time, airplanes and equipment available for war-time tasks. CAP volunteers flew anti-submarine coastal patrol, courier service and performed other national defense services during WWII.

CAP activities include (1) a national program of aerospace education (2) participation in USAF-authorized search and rescue missions; (3) participation in disaster emergency services, nationally and locally; and (4) cooperation with and support of Civil Defense and the American Red Cross disaster relief programs. CAP insignia are included on the decal sheet in this kit for application to your model.

USE CEMENT SPARINGLY

All plastic cements contain solvents that dissolve the plastic, forming a weld between two parts. Avoid getting cement on the outside surfaces. If too much cement is used, it will

damage the surface or may soften the plastic and cause it to shrivel. Use only enough cement to stick parts together. You will have a much neater model and will preserve the fine finish.

COLOR FINISHING SUGGESTIONS

The suggested colors given below are intended for the less experienced builders. The painting is kept to a minimum while adding some additional color to the model, to enhance its appearance. For the experienced builder, the full exterior color scheme is shown in step sixteen of the assembly instructions. The official Piper Tri-Pacer trim colors represented by the gray areas in step sixteen are Cadillac Red, Key West Blue or Pasadena Rose. Use one of these colors for your trim. The cabin interior can be painted in contrasting colors to suit the individual. Paint the interior details before assembling the model.

- SILVER — Propeller blades, engine mounts and rudder pedals.
- BLACK — Dashboard, control wheels, tires, camera, barrel of rifle, engine, and grill on front of cowling.
- BROWN — Hunters' boots and rifle stock.
- TAN — Lion, pants, jacket and base of hunter with camera, and pants of hunter with rifle.
- RED — Lion's tongue, hunters' hats, jacket of hunter with rifle.
- WHITE — Scarf around neck of hunter with rifle.
- FLESH — Hunters' faces and hands.



MONOGRAM MODELS, INC.

Morton Grove, Ill. Copyright © 1957 & 1967

All rights reserved.

Made in U.S.A.

READ THIS BEFORE YOU BEGIN ASSEMBLY

Study the exploded drawing and the sketches on the following pages to become familiar with all of the parts of the model and how they fit together. Then follow carefully the procedure shown and you will be rewarded with a beautiful scale model. Be sure to check the fit of each part before you cement it in place.

Before starting assembly, remove all plastic parts from the "trees" to which they are attached and carefully trim away any excess bits of plastic with a sharp knife.

Use a cement for styrene plastic to join the parts of your model. Use the cement sparingly. Too much will ooze out of the joints and could cause the plastic to soften.

If you are going to paint the details on your model, refer to the suggested colors and the paragraph on painting.

Before applying decals read the directions "How To Apply Decals" and be careful in handling the model so decals do not shift.

Study this Exploded Drawing . . . and become familiar with the name of every part, where it goes and how it fits with other parts before you begin assembly.

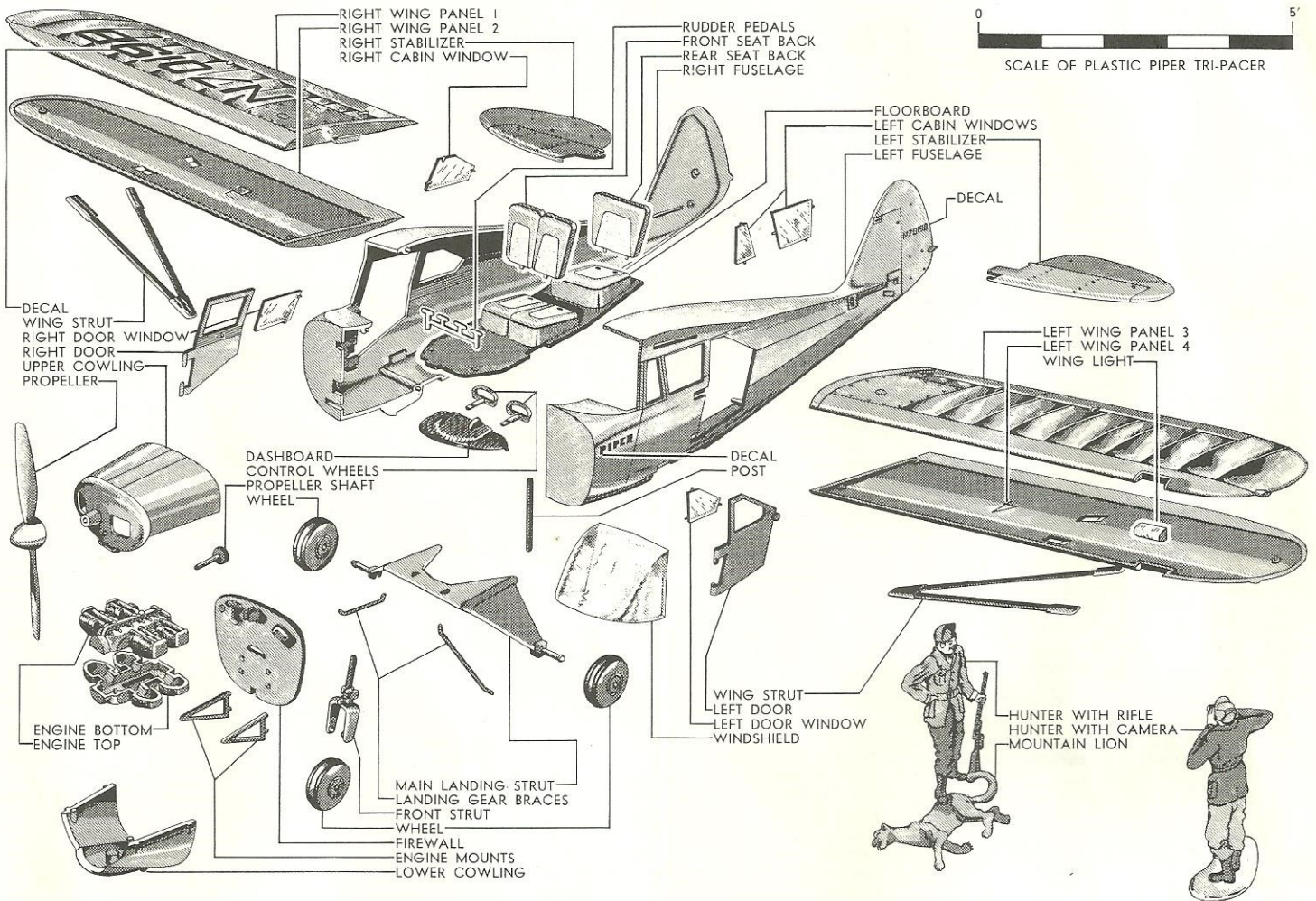

HOW TO APPLY DECALS

Cut the decal apart with scissors inside the dotted line. For a neat job, trim right close to color outline with scissors. Work with one subject at a time. Dip it in water for a few moments until it slides easily on the paper backing. Study drawings for correct location. Slide the decal partly off of the paper backing, holding decal in correct place on model while sliding backing out from underneath. The decal can be shifted on the model into the correct position after lifting it and applying a little water around the edges with your finger. Press out bubbles and blot with a soft rag.

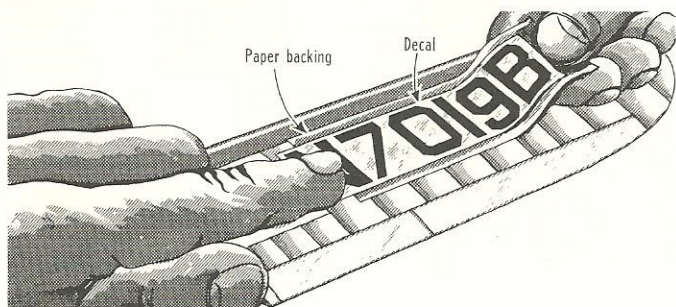

PAINTING YOUR MODEL

If you are going to paint your model, read the assembly instructions before you begin assembly and plan your work because it is easier to paint some parts **before** they are attached to the model and before decals are applied. Follow the suggested colors on the front page. Only **enamel** or **paint for plastics** should be used. Use a small pointed brush for details. Do **not** paint surfaces that will be cemented because cement will not hold well to a painted surface. Allow time for paint to dry thoroughly before handling parts. Clean and wipe brushes thoroughly before using another color.

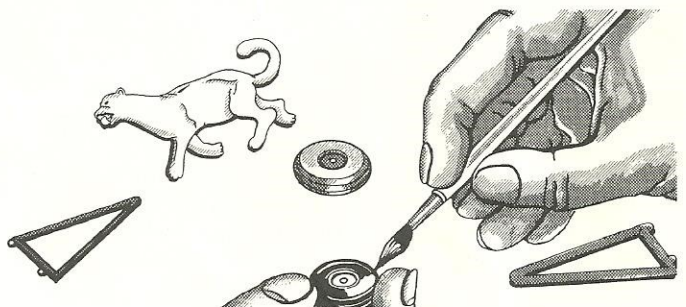

TRI-PACER ASSEMBLY DIRECTIONS

CAUTION: WHEN USING CEMENT, USE SPARINGLY. TOO MUCH WILL CAUSE PLASTIC TO SOFTEN

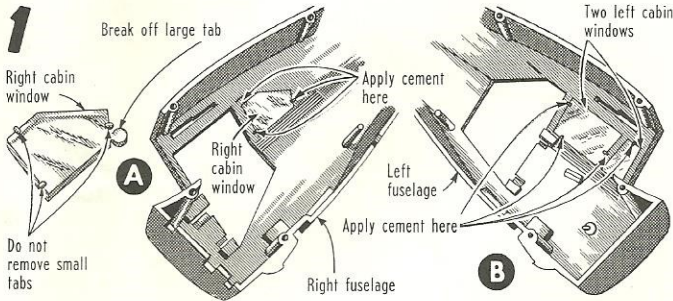

(A) Break **large tab** off of right cabin window. Trim away any surplus taking care **not** to cut away small tabs. Insert window into opening in right fuselage with small tabs on **inside** and apply cement sparingly to small tabs. (B) Break large tabs off of two left cabin windows. Insert windows into left fuselage and apply cement.

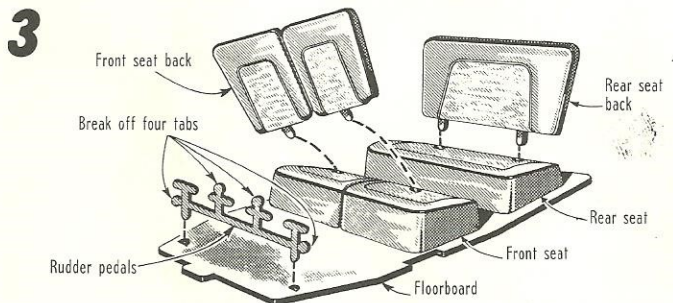

Break off four large tabs on rudder pedals. Apply a drop of cement to each hole at front of floorboard and insert rudder pedals. Apply a drop of cement to four holes in seats. Insert pegs on front seat back into holes in front seat. Attach rear seat back to rear seat.

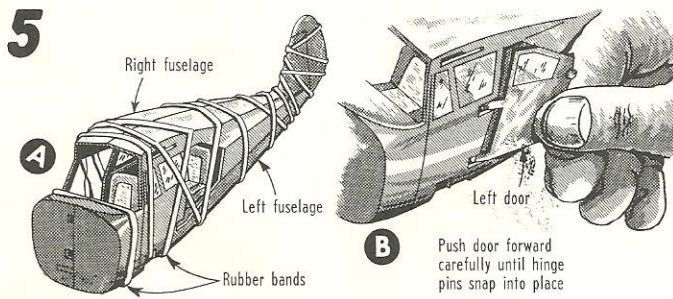

(A) Apply cement along edge of floorboard and edge of left fuselage. Join the fuselage halves making sure rear of floorboard fits **under** peg in left fuselage. Bind fuselage with rubber bands for a tight cement joint. Remove bands when dry. (B) Hold left door in slightly open position and snap door hinges forward into place. **Do not use cement.** Also insert right door.

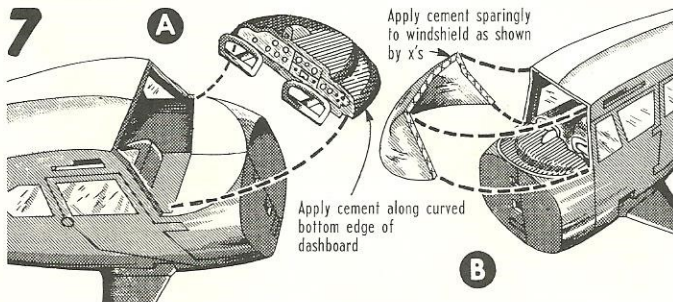

(A) Apply cement along **curved** bottom edge of dashboard. Do not apply any cement to **straight** edge of dashboard. Insert dashboard into fuselage and pull it towards the **front** of fuselage as far as it will go. (B) Apply cement **sparingly** to back edge of windshield only. Attach windshield to fuselage.

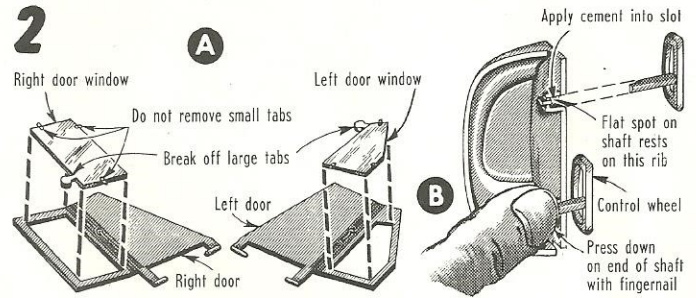

(A) Break **large tabs** off right and left door windows. Trim off any surplus taking care **not** to cut away small tabs. Insert windows into doors as shown and apply cement to small tabs on windows. (B) Apply cement sparingly into two slots in bottom of dashboard and attach control wheels. Flat spot on end of shaft rests on rib in end of slot.

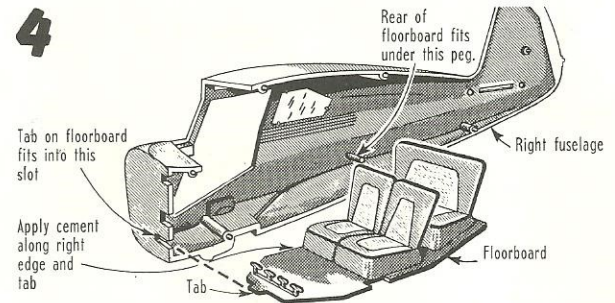

Apply cement along **right** edge of floorboard and to tab on front of floorboard. Insert floorboard into right fuselage. Make sure tab on floorboard fits into slot in front of fuselage and that rear of floorboard fits **under** peg in fuselage as indicated above. Press floorboard against side of fuselage.

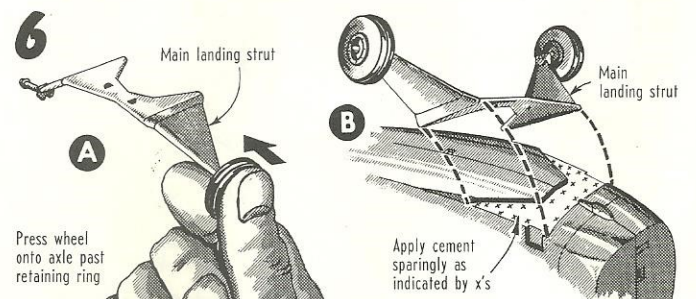

(A) Snap wheels onto axles of main landing strut past retaining rings on ends of axles. Do not cement. (B) Apply cement sparingly to area in bottom of fuselage as indicated by x's. Place main landing strut into recess in fuselage and keep it pressed down tightly against fuselage until cement sets.

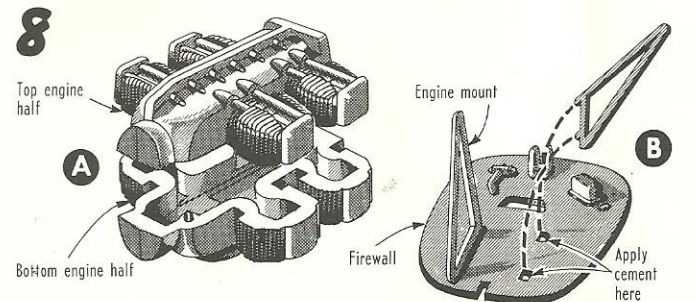

(A) Cement top and bottom engine halves together. (B) Apply cement to four holes in firewall as shown above. Insert pegs on engine mounts into holes in firewall. Note the shape of the pegs on the engine mounts and make sure they fit into the correct holes in firewall. The flat side of the engine mounts should face toward the inside.

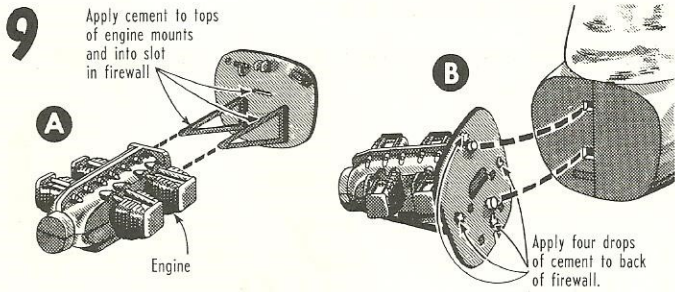

(A) Apply cement to tops of engine mounts and into slot in firewall. Place engine onto engine mounts and push tab on back of engine into slot in firewall. (B) Apply four drops of cement to back of firewall as shown and attach it to front of fuselage.

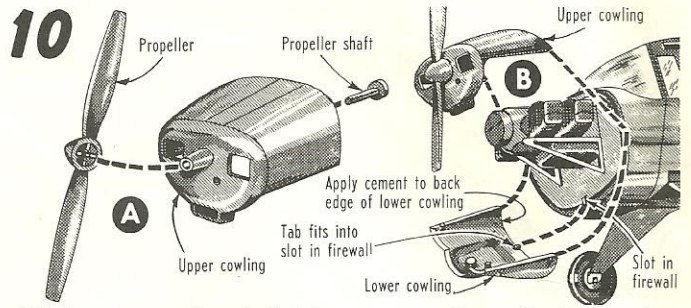

(A) Insert propeller shaft into upper cowling. Apply tiny drop of cement to end of propeller shaft and press propeller onto shaft. (B) Cement lower cowling to fuselage. Press upper cowling in place. **Do not cement.** Rib inside cowling fits between two tabs on firewall. Upper cowling is removable so that engine may be displayed.

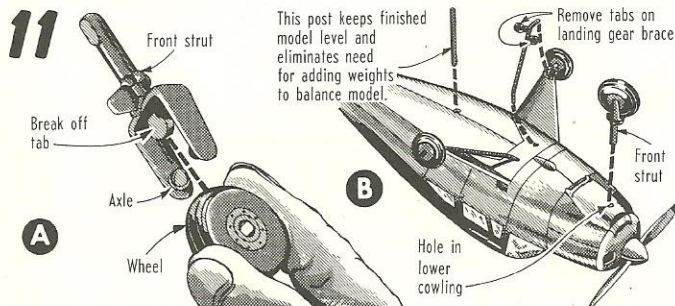

(A) Break off tab on front strut. Snap wheel onto axle of front strut. (B) Apply a tiny drop of cement into hole in lower cowling and insert front strut into hole. Remove tabs from landing gear braces. Cement landing gear braces to landing gear as shown. Apply cement to end of post and insert it through hole in fuselage.

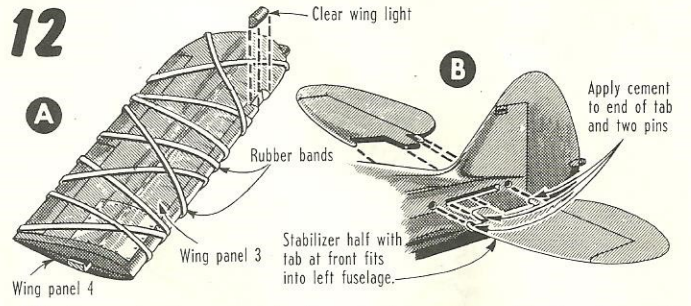

(A) Cement wing panels 3 and 4 together. Bind wing with rubber bands as shown. Insert clear wing light into wing and apply a tiny bit of cement. Also join wing panels 1 and 2. (B) Apply cement to ends of large tabs on stabilizer halves and two pins on ends. Insert stabilizer that has tab at front into left fuselage. Attach other stabilizer into right fuselage.

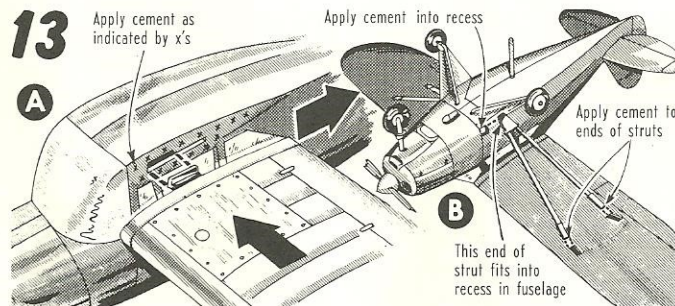

(A) Apply cement sparingly to side of fuselage as indicated by x's. Insert tab on end of wing into front of slot, then push wing back as far as it will go. Attach other wing. (B) Apply cement to recess in fuselage and to two ends of wing struts. Insert struts into wing and then snap other end of strut into recess in fuselage. Attach struts to other wing.

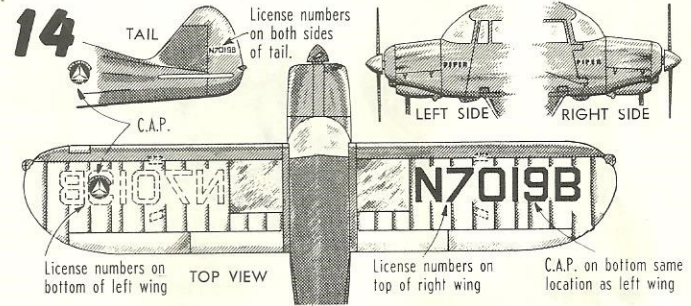

Apply large numbers and CAP decals to wings as shown. Small numbers and lettering are positioned as in small sketches. One CAP emblem is applied to each side of fuselage. Refer to paragraph "How to Apply Decals" on page 2 and follow the instructions closely.

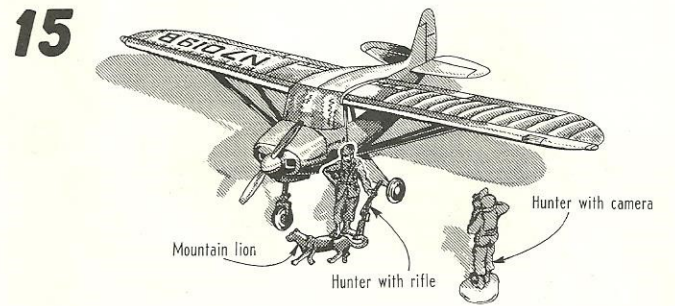

Cement the hunter with the rifle to the mountain lion with his right foot resting in the depression in the lions body near the hind leg. Cement the toe of his left shoe to the tip of the lion's tail. Arrange the figures near the plane as shown to finish your sports plane scene.

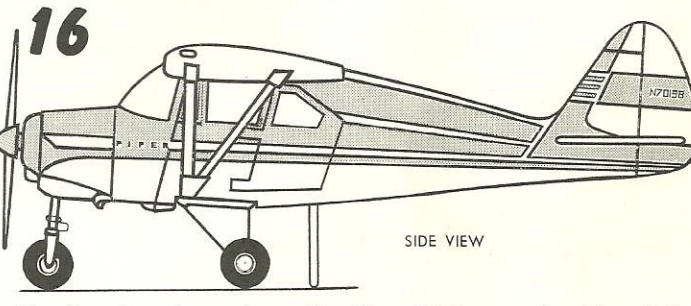

The drawing above shows the Piper Tri-Pacer color trim. **It is intended only for the experienced modeler who wishes to paint his model completely.** The official Piper Tri-Pacer trim colors are Cadillac Red, Key West Blue, or Pasadena Rose. The above drawing is one half the size of the plastic model, so dimensions scaled off the drawing must be increased two times.