

1

★ APPLY EXPRESS MASK AND PAINT BEFORE GLUING  
POUŽIT EXPRESS MASK NABARVIT PŘED SLEPENÍM

◐ SYMMETRICAL ASSEMBLY  
SYMETRICKÁ MONTÁŽ

◑ REMOVE  
ODSTRANIT

◒ GRIND  
OBROUSIT

◓ DRILL HOLE  
VRTAT OTVOR

4 3D DECAL PARTS  
3D OBTISKY

1 COLORED ETCHED PARTS  
LEPTANÉ BAREVNÉ DÍLY

1 ETCHED PARTS  
LEPTANÉ NEBAREVNÉ DÍLY

1 ORIGINAL KIT PARTS  
PŮVODNÍ DÍLY STAVEBNICE

◔ BEND  
OHNOUT

◕ OPTION  
VOLBA

◖ REPLACE  
NAHRADIT

■ ORIGINAL KIT PARTS  
PŮVODNÍ DÍLY STAVEBNICE

■ COLORED 3D DECAL PARTS  
BAREVNÉ 3D OBTISKY

■ PHOTO-ETCHED PARTS  
LEPTANÉ DÍLY

■ PARTS TO BE REMOVED  
DÍLY K ODSTRANĚNÍ

■ FILL  
TMELIT

3DL 48092 **Bf 109G-14/AS** 1/48

detail set for 1/48 EDUARD kit • sada detailů pro stavebnici 1/48 EDUARD

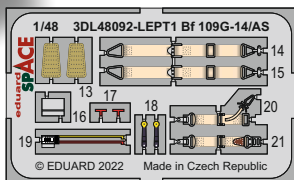
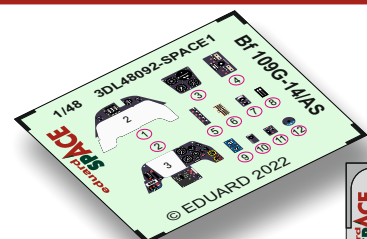

eduard  
**SPACE**

© EDUARD 2022 Made in Czech Republic

2

### 3D decals

• Soak the decal in the warm water for couple of seconds and after its separation from the backing paper position it on the model.

• To increase decal's adherence use the white glue, Mr. Mark Setter or apply to the glossy surface.

• Leaving decal in the water for too long can cause its swelling and distortion.

### PE parts

• Use cyanoacrylate glue to attach.

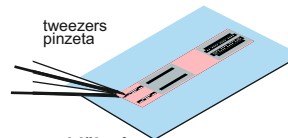

### 3D decals

• Vložte na několik vteřin do teplé vody a po oddělení od podkladového papíru naneste na model.

• Pro zvýšení přilnavosti lze použít disperzní lepidlo, Mr. Mark Setter či obtisk nanášet na lesklý povrch.

• Příliš dlouhé vystavení 3D obtisku vodě může způsobit jeho nabobtnání.

### PE parts

• K lepení použijte kyanoakrylátové lepidlo.

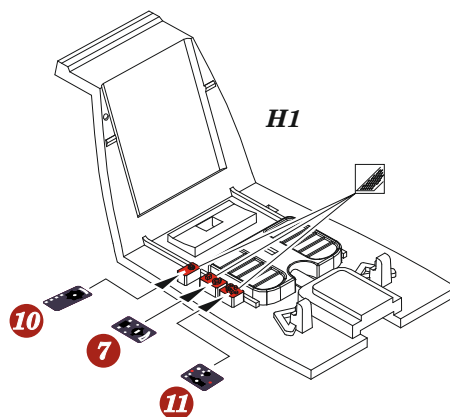

3

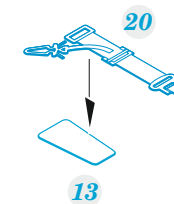
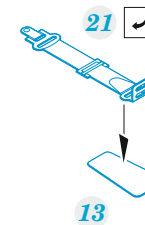

13

13

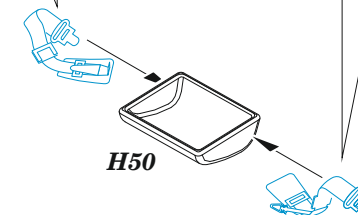

H50

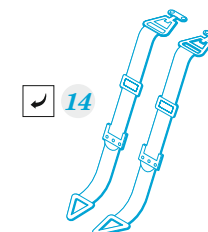

14

15

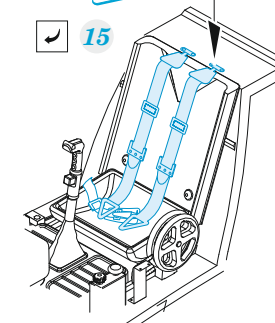

H1

