

Caracal Models

CD48207

HUP-2

RETRIEVER

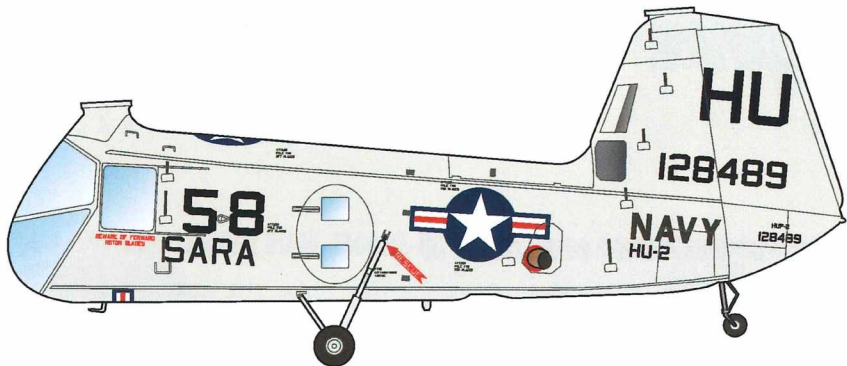

**NINE MARKING OPTIONS
FOR US NAVY AND ROYAL CANADIAN NAVY
HUP RETRIEVER HELICOPTERS**

1/48 SCALE

DECALS PRINTED BY



**OPTION 1: HUP-2 RETRIEVER BUNO. 128489, HU-2
USS SHANGRI-LA**

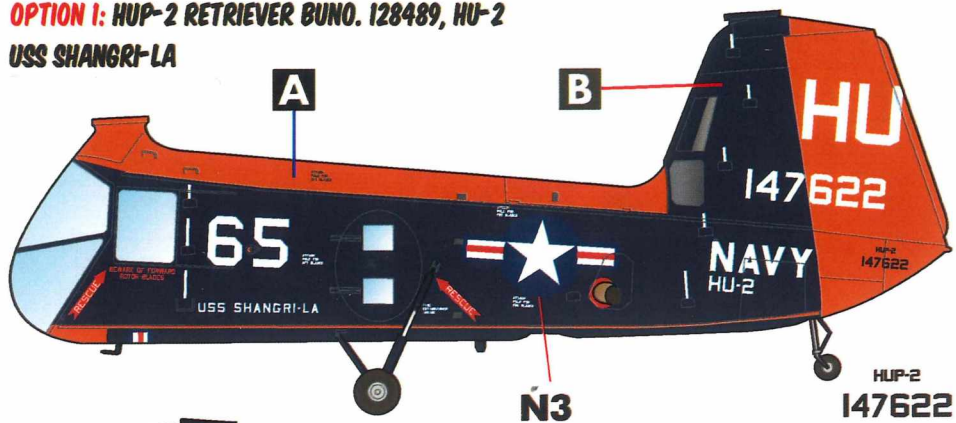

NOTE FUSELAGE STRAKE PAINTED INTERNATIONAL ORANGE

OPTION 2: HUP-2 RETRIEVER BUNO. 128519, HU-2

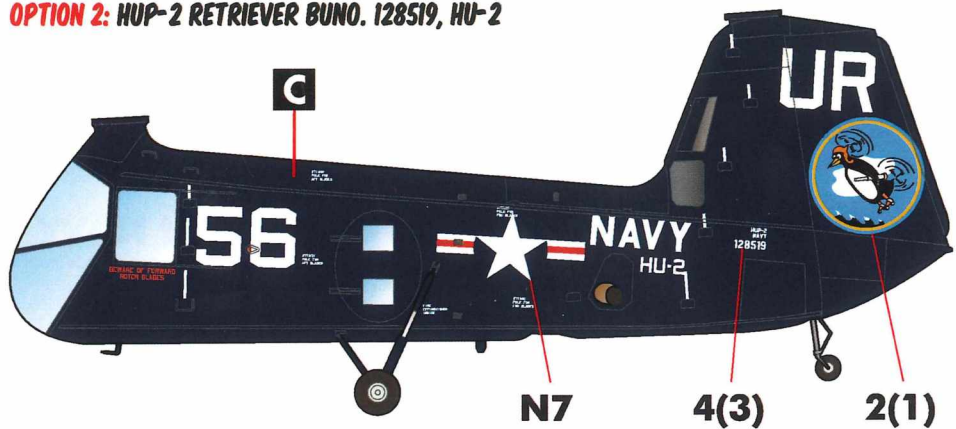

OPTION 3: HUP-2 RETRIEVER BUNO. 128515, NAS MOFFETT FIELD

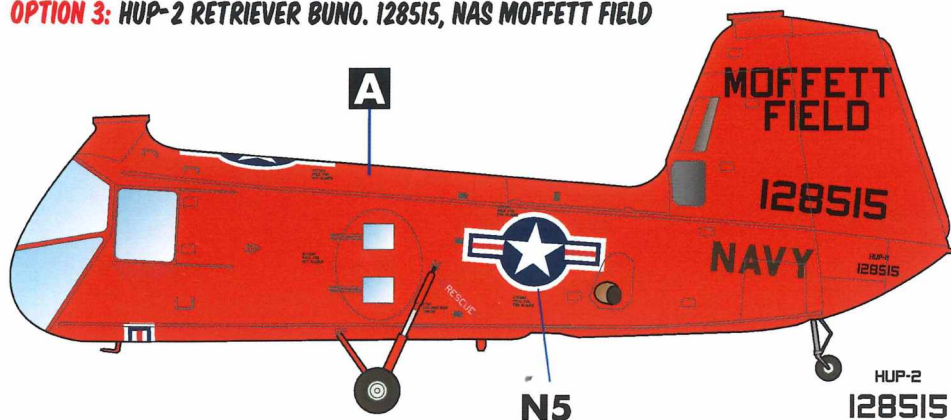

PHOTOS SHOW ONLY A FEW STENCILS ON THIS HELICOPTER

**OPTION 4: HUP-2 RETRIEVER BUNO. 128489, HU-2
USS SARATOGA**

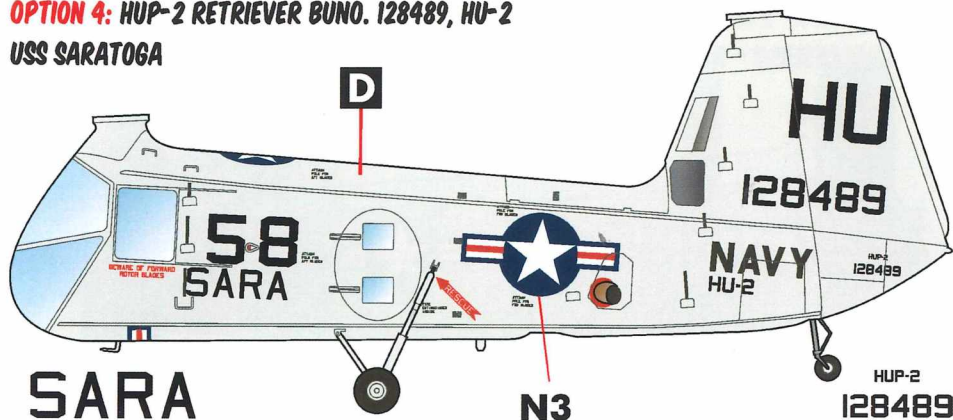

**OPTION 5: HUP-2 RETRIEVER BUNO. 130022, HU-2
USS ROOSEVELT**

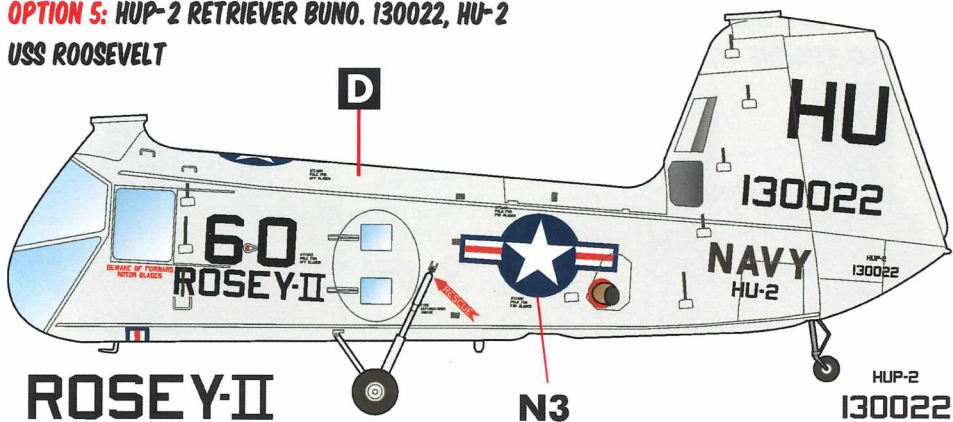

OPTION 6: HUP-2 RETRIEVER BUNO. 128572

US NAVY RESERVE - NAS DALLAS

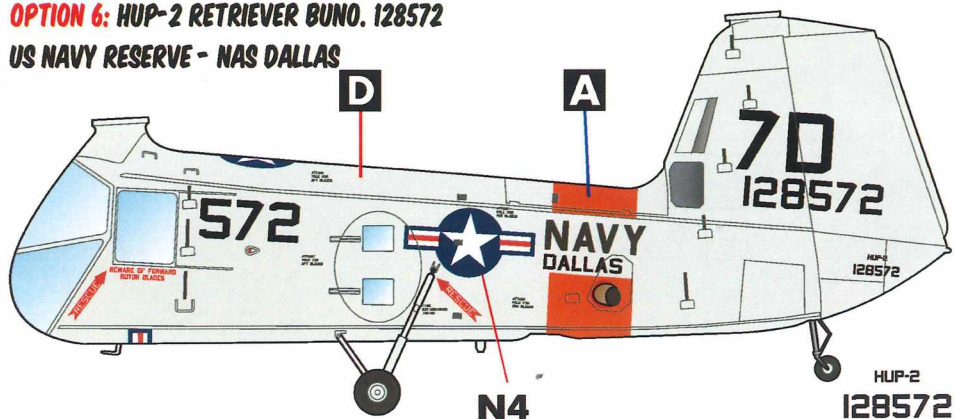

NOTE HOW THE NATIONAL INSIGNIA OVERLAPS THE FUSELAGE HATCH

OPTION 7: HUP-2 RETRIEVER BUNO. 130062

US NAVY RESERVE - NAS SOUTH WEYMOUTH

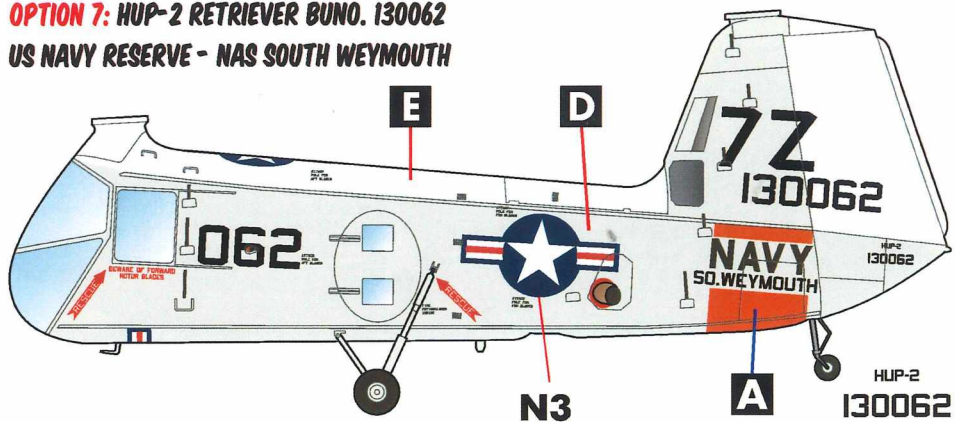

OPTION 8: HUP-2 RETRIEVER BUNO. 128496

US NAVY RESERVE - NAS NEW YORK

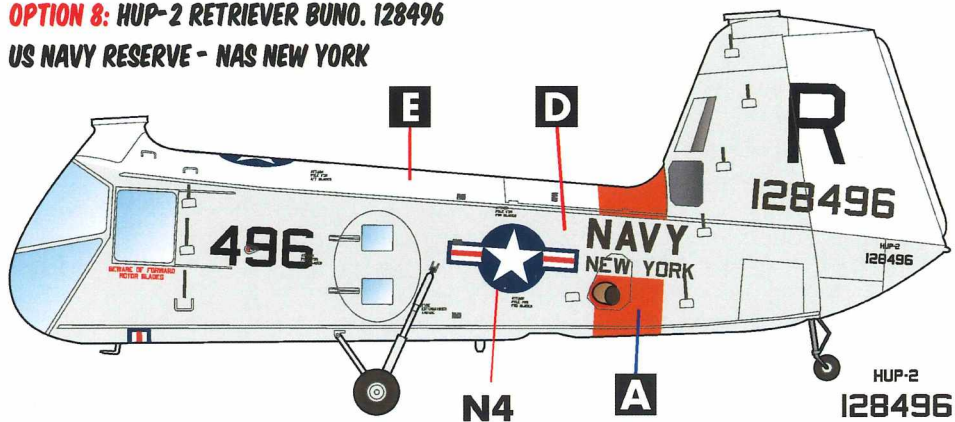

OPTION 9: HUP-3 RETRIEVER 116623
ROYAL CANADIAN NAVY

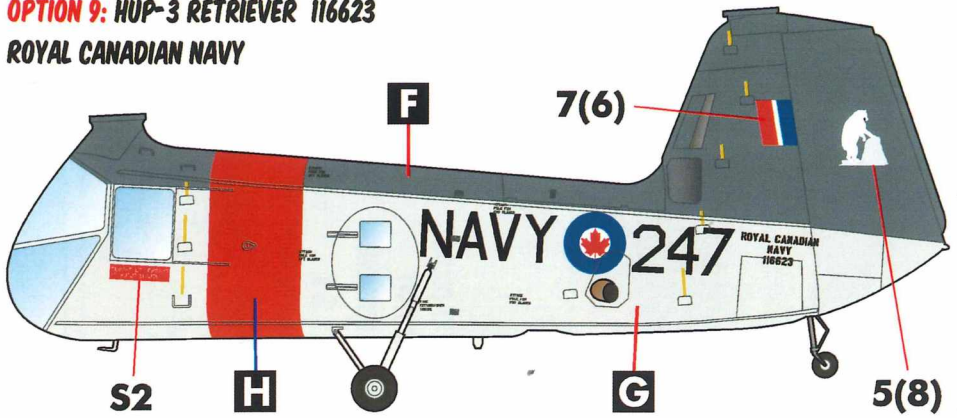

USE YELLOW STRIPES TO MARK THE FOOTHOLDS.

OPTION 1

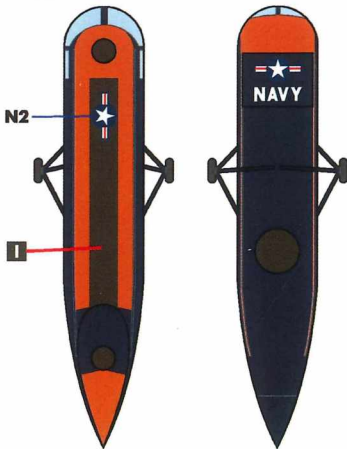

OPTION 2

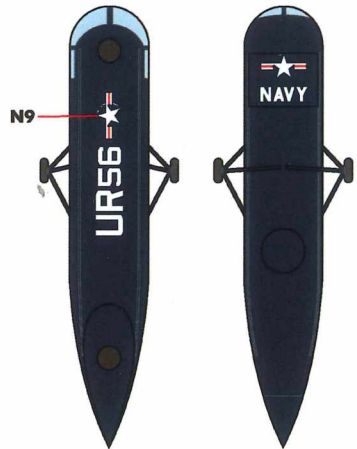

OPTION 3

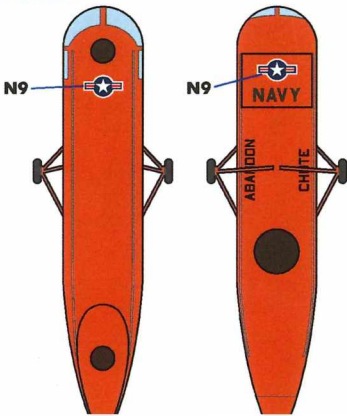

OPTION 4

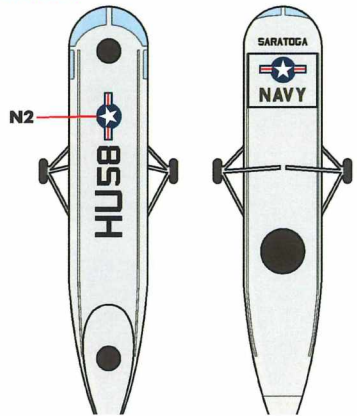

COMMON STENCILING

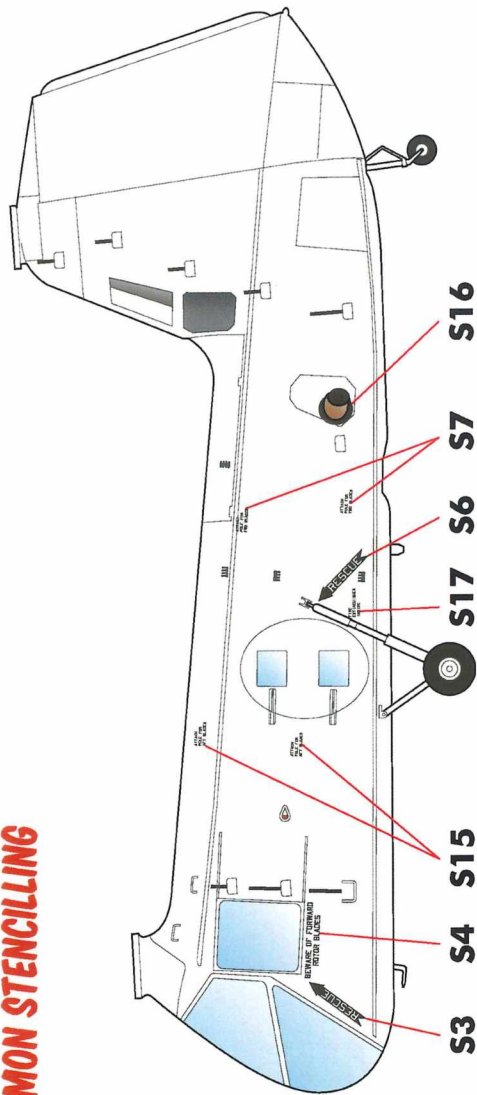

S3 S4 S15

S17 S6 S7

S16

SOME OF THE STENCILS ARE REPEATED IN DIFFERENT COLORS
GENERALLY THE STENCILS ARE PAINTED IN COLORS THAT
CONTRAST THE BACKGROUND. USE APPROPRIATE VERSIONS
FOR THE COLOR SCHEME OF YOUR CHOICE.

TRIM AND USE THE STRIPES PROVIDED
(DECALS S10, S11 & S12) TO REPRESENT
THE MARKINGS FOR FOOTHOLDS
ON EACH SIDE OF THE FUSELAGE

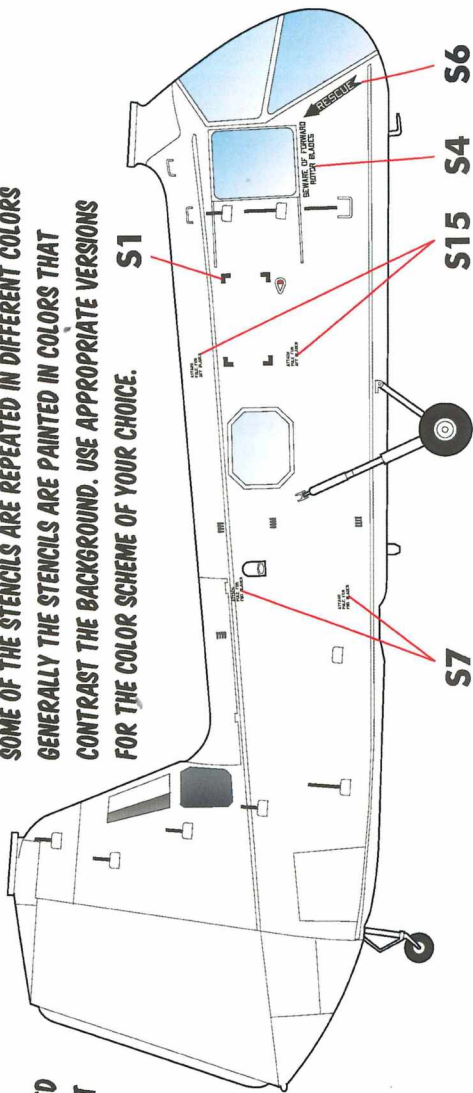

S7

S15

S4

S6

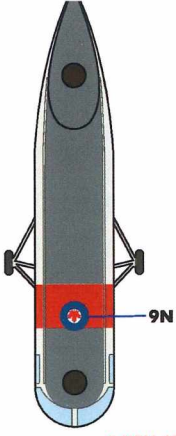
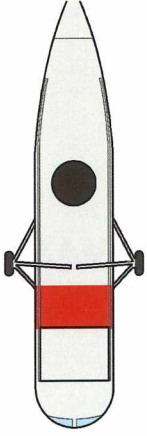

OPTION 9

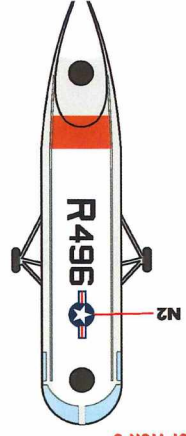
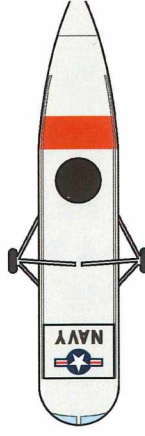

OPTION 8

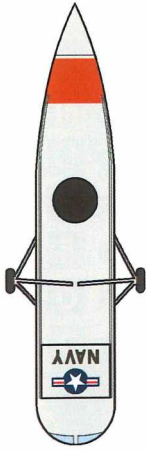

OPTION 7

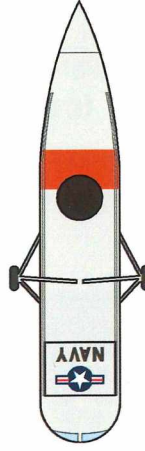

OPTION 6

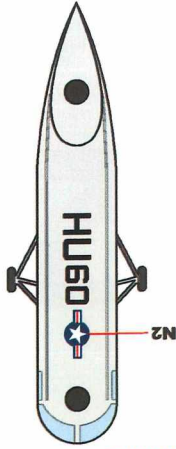
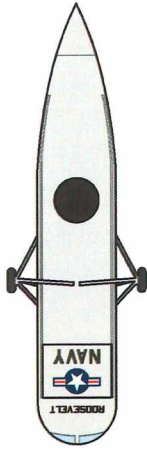

OPTION 5

COLOR LIST

- A** INT. ORANGE (FS12197)
- B** ENGINE GRAY (FS26081)
- C** GLOSS SEA BLUE (FS15042)
- D** LIGHT GULL GRAY (FS36440)
- E** FLAT WHITE (FS37875)
- F** 501-102 DARK GREY (FAA EXTRA DARK SEA GREY)
- G** 501-106 LIGHT GREY (BS381C-637 MEDIUM SEA GREY)
- H** FLUORESCENT RED-ORANGE (FS28913)
- I** FLAT BLACK (FS37038)