

SKY MODELS

SKYMODELS
 VIA DEI VELIERI 142
 00121 - ROME - ITALY
 PH. & FAX 0039 615674110
 E-MAIL: skymodels@tiscalinet.it
 VISIT OUR WEB SITE:
 web.tiscalinet.it/skymodels

P-47 THUNDERBOLT

1/72ND SCALE

72 - 050

PAINT SCHEMES AND COLORS ARE ONLY SUGGESTED, SOME SOURCES SUGGEST OTHER COLOURS, MODELLER MUST USE HIS OWN SOURCES.

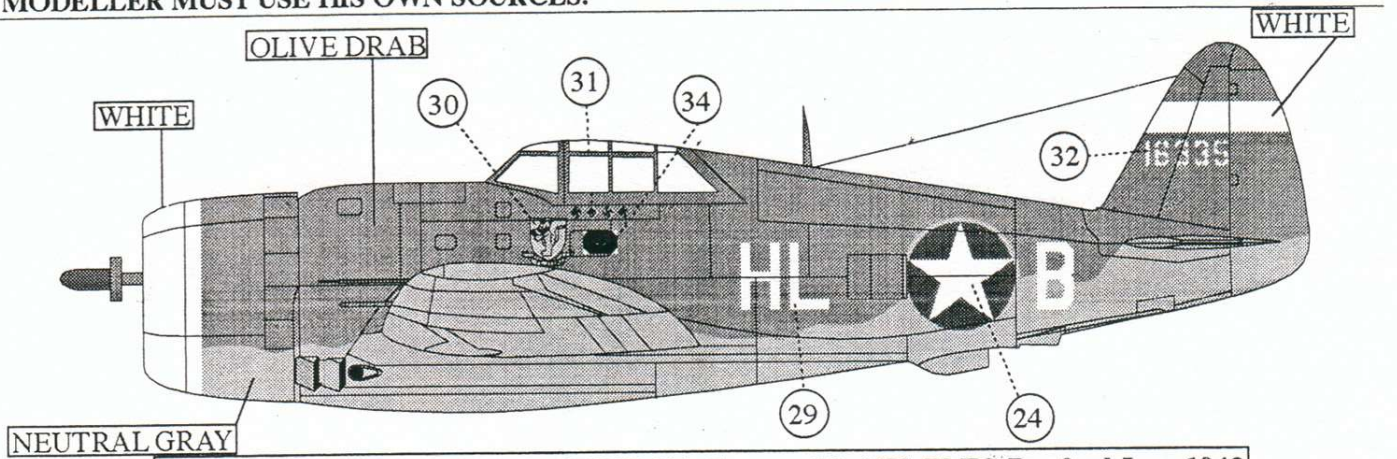

P 47 C-5 41-6335, Capt. Charles LONDON, -5 scores-83rd FS-78 FG, Duxford, June 1943

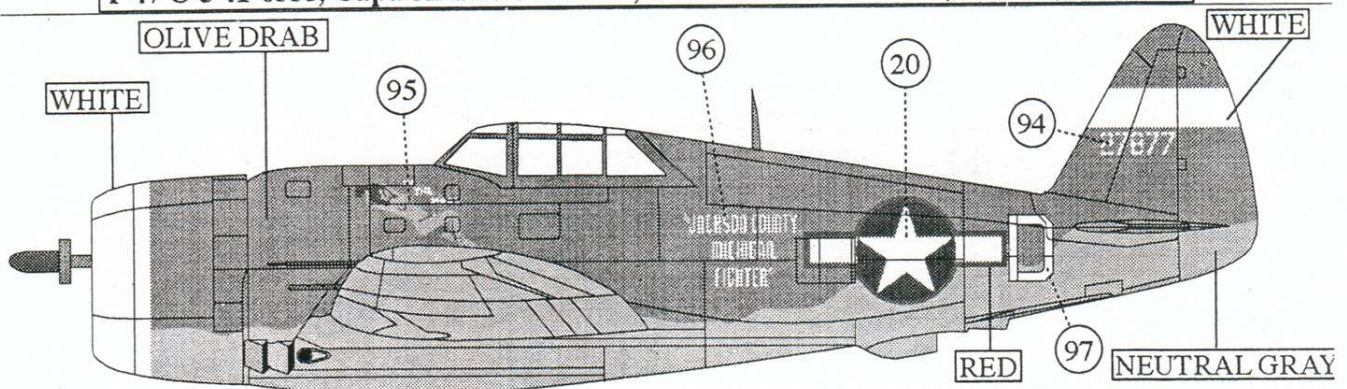

P 47 D-1 42-7877, Capt. Gerald JOHNSON, -5.5 scores-61 st FS-56th FG, Halesworth, October 1943

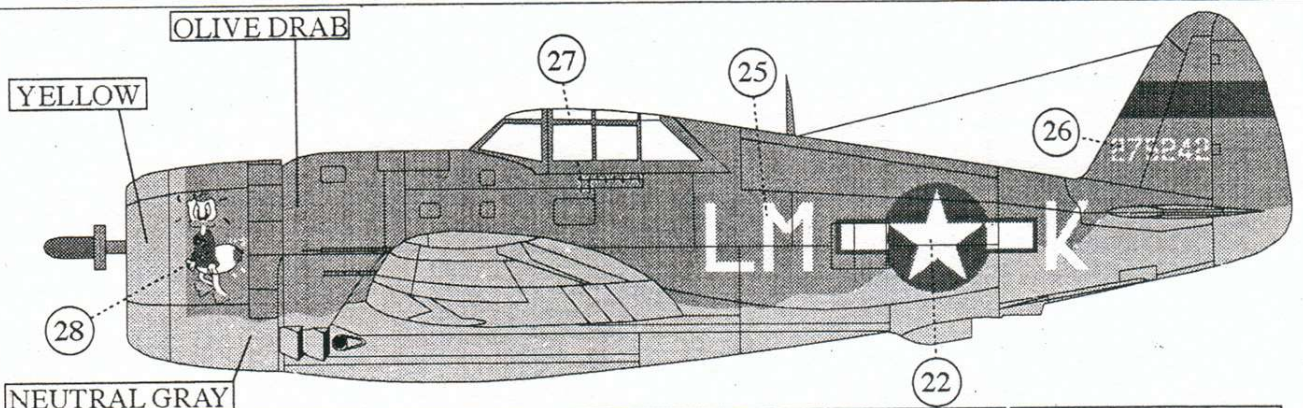

P 47 D-11, 42-75242, Capt. Michael QUIRK, -11 scores-62nd FS-56th FG, Halesworth, february 1944

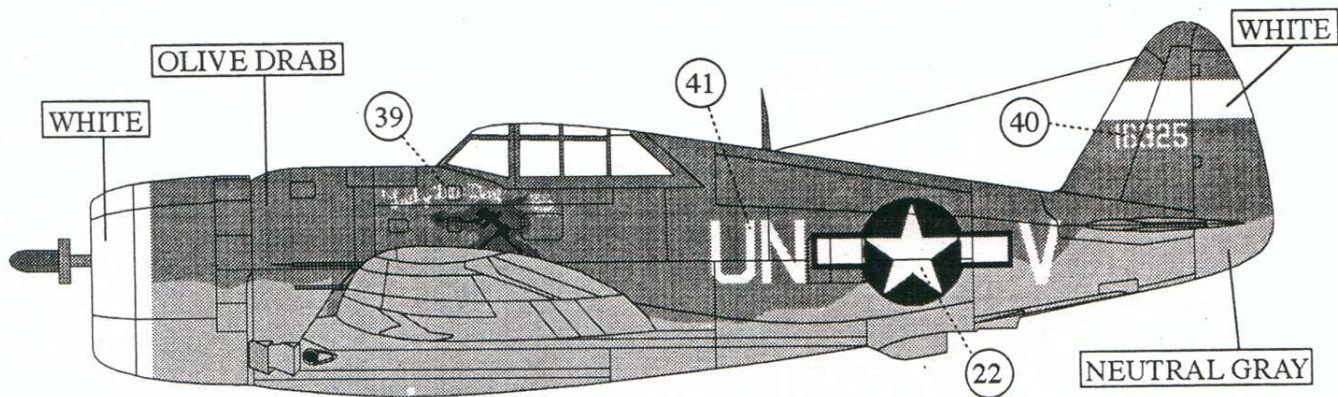

P 47 C-5 41-6325, Lt. John VOGT, -8 scores-63rd FS-56th FG, Halesworth, October 1943

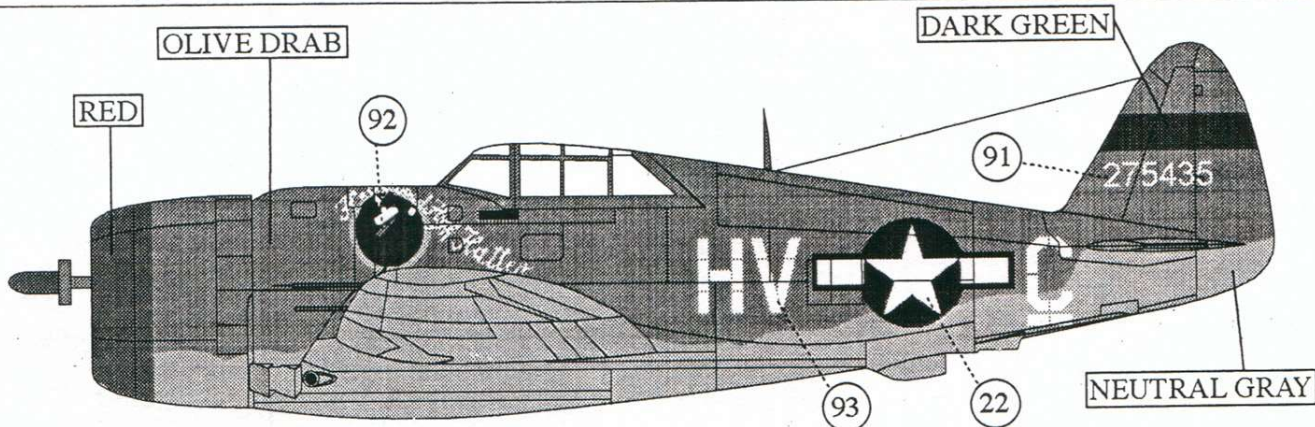

P 47 D-11, 42-75435, Lt. Paul CONGER, -11.5 scores-61st FS-56th FG, Halesworth, December 1943

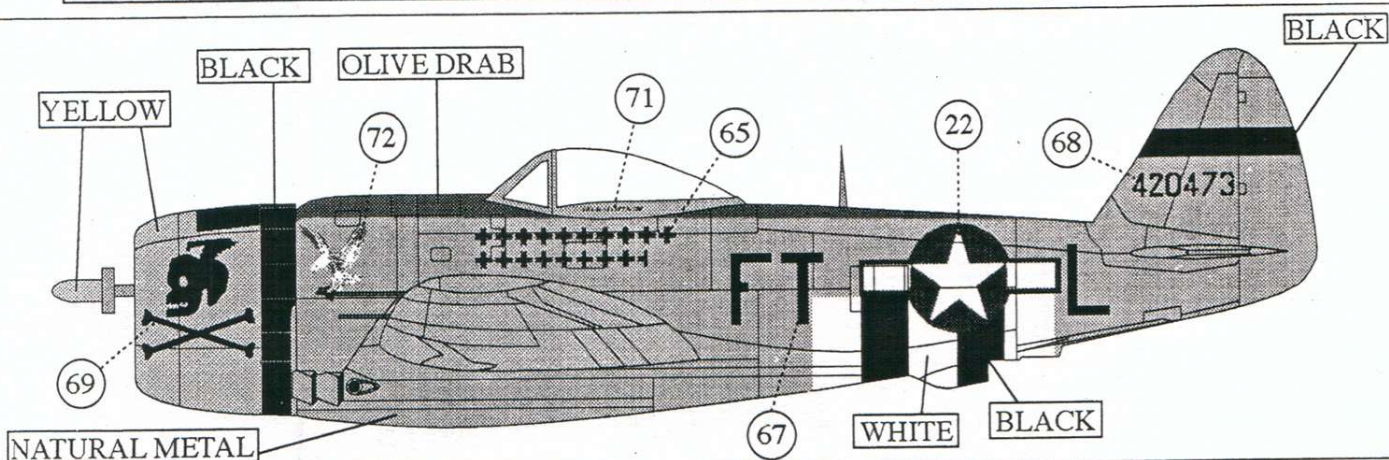

P 47 D-30, Maj. Glenn EAGLESTON, -18.5 scores-CO 353rd FS-354th FG, Rosieres en Haye, France, December 1944

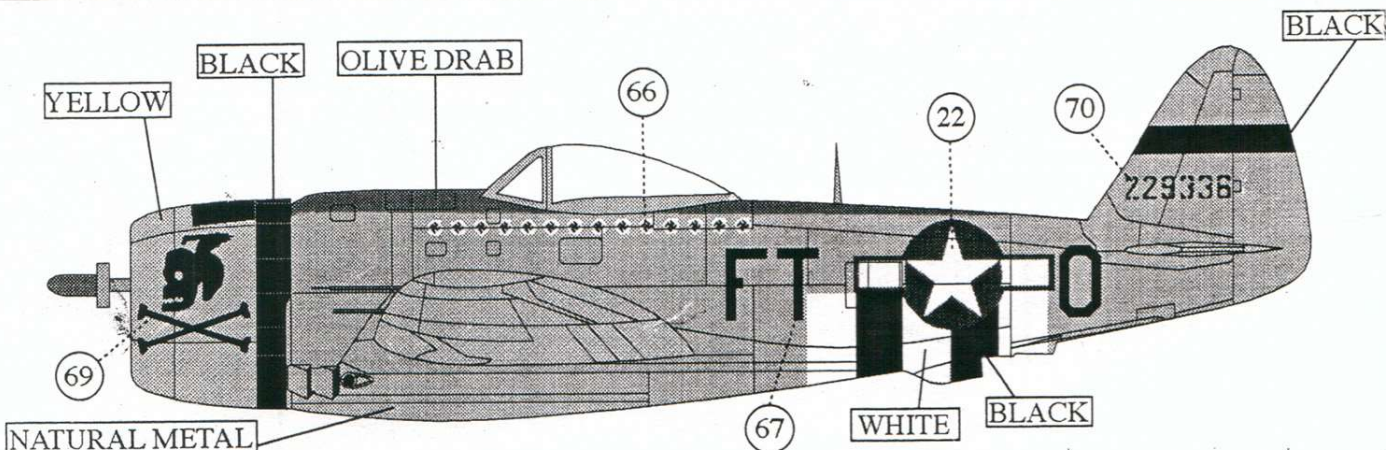

P 47 D-28, Capt. Kenneth H. DAHLBERG, - 14 scores- 353rd FS-354th FG, Rosieres en Haye, France, February 1945

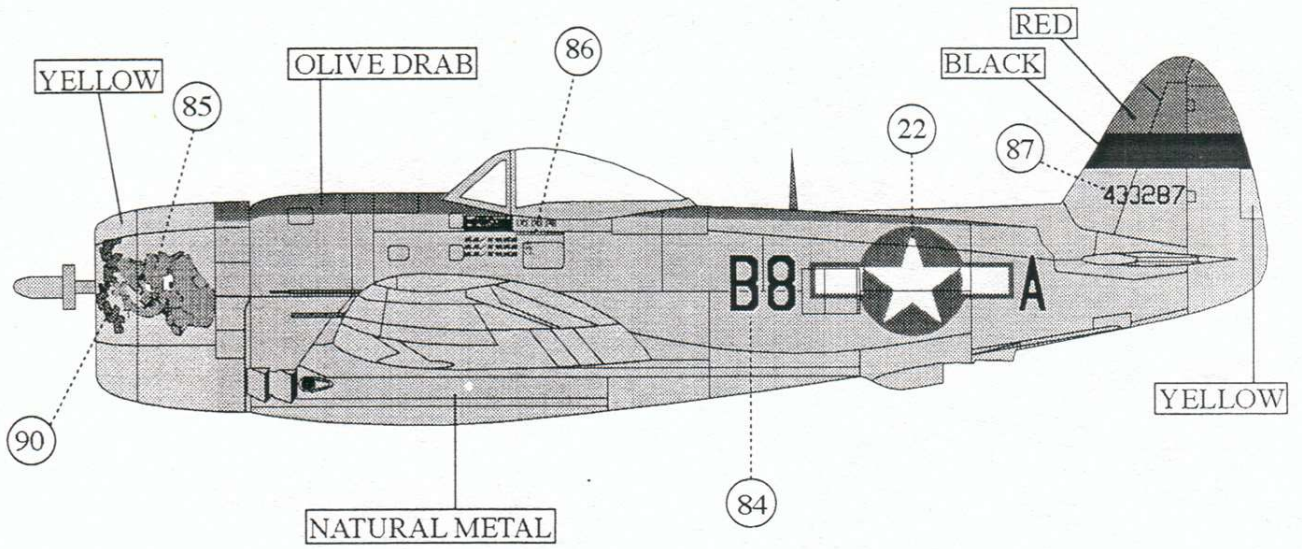

P 47 D-30, Col. Joseph LAUGHLIN, CO 362nd FG, Furth, Germany, April 1945

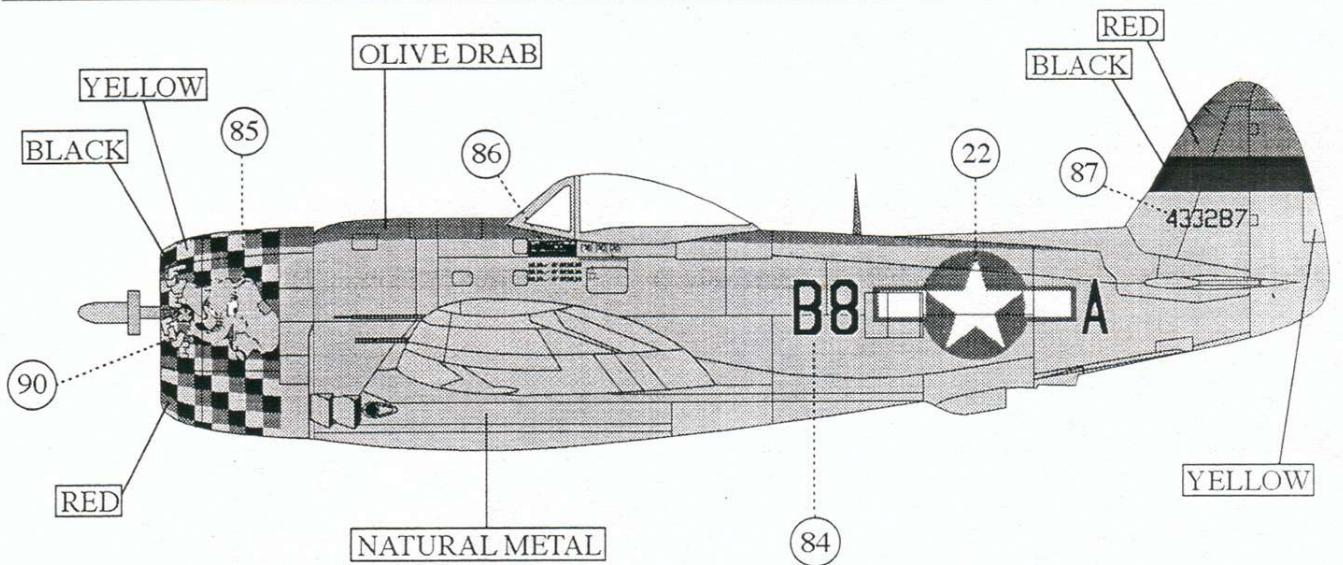

P 47 D-30, Col. Joseph LAUGHLIN, CO 362nd FG, Straubing, Germany, May 1945

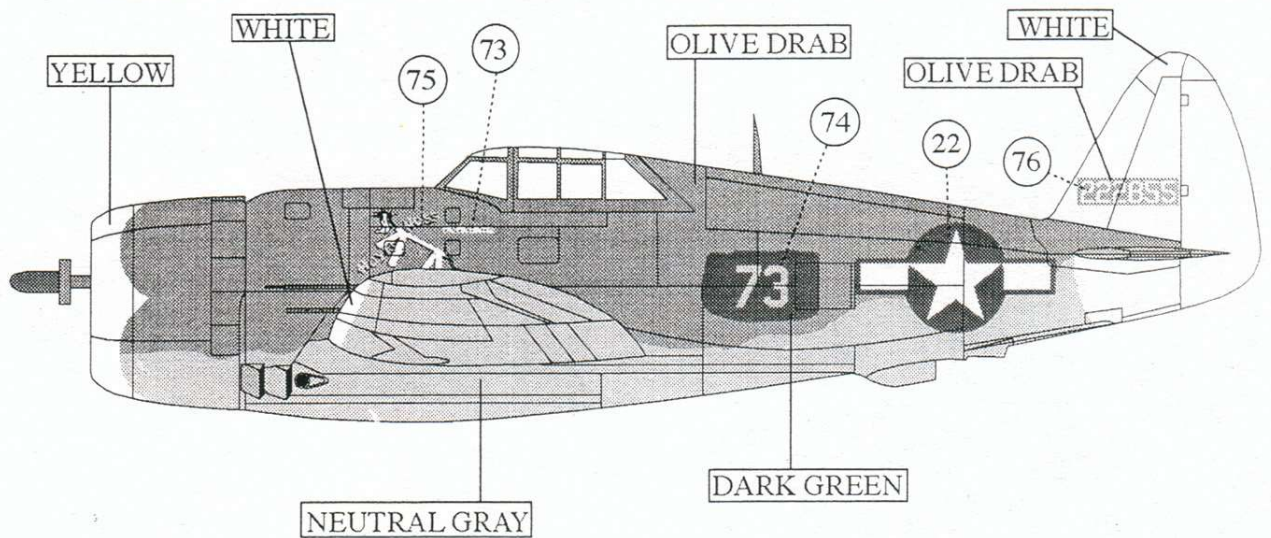

P 47 D-11, Lt. Edward R. HOYT, -5 scores- 41st FS-35th FG, Gusap, March 1945

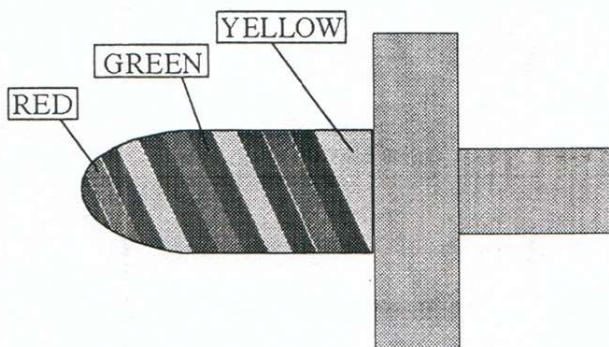
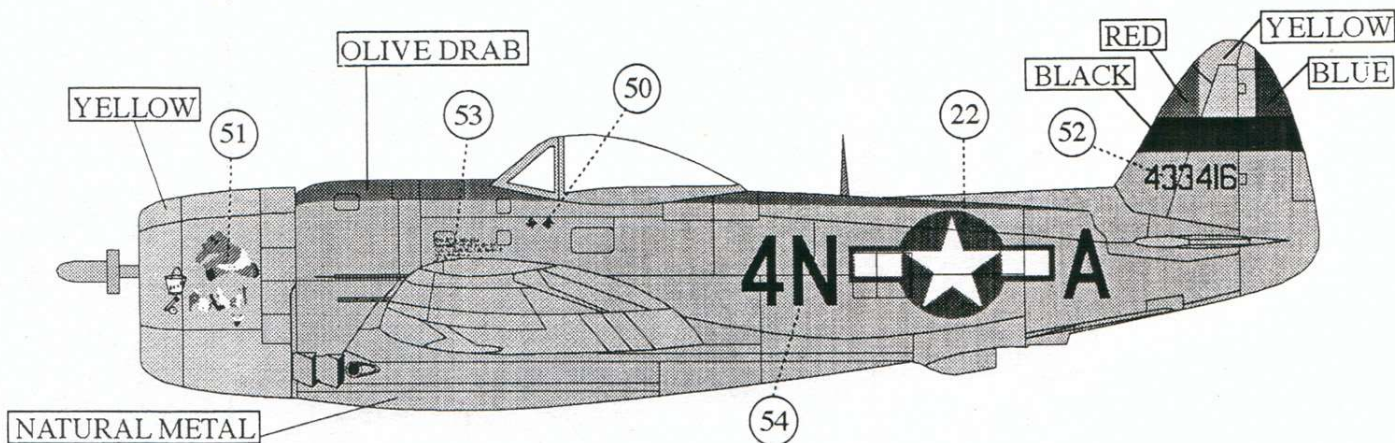

P 47 D, Maj.C.F.MATHESON,- 2 scores- 394th FS, Furth,Germany, spring 1945

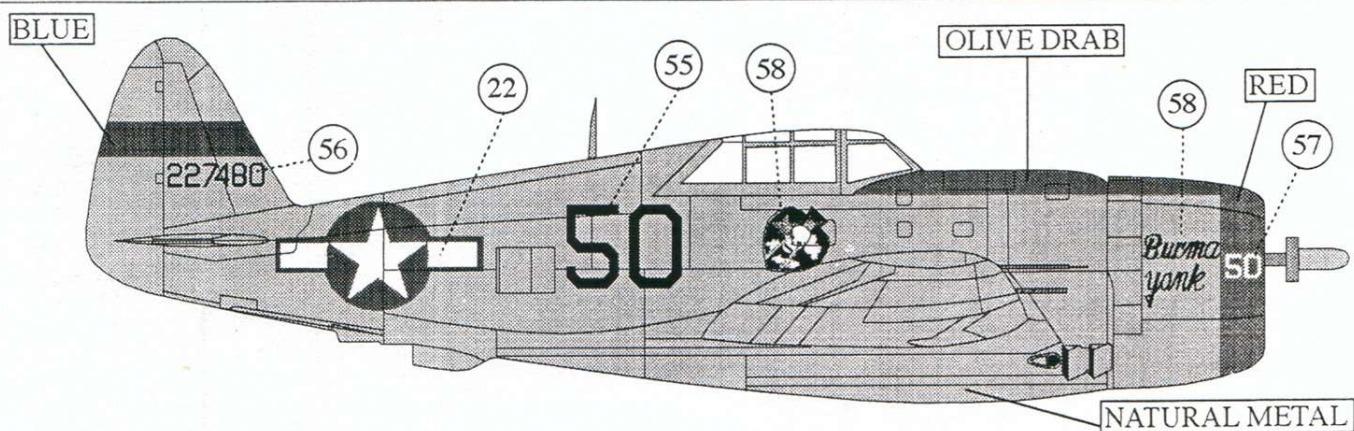

P 47 D, 89th FS,80th FG,Myitkyina,Burma

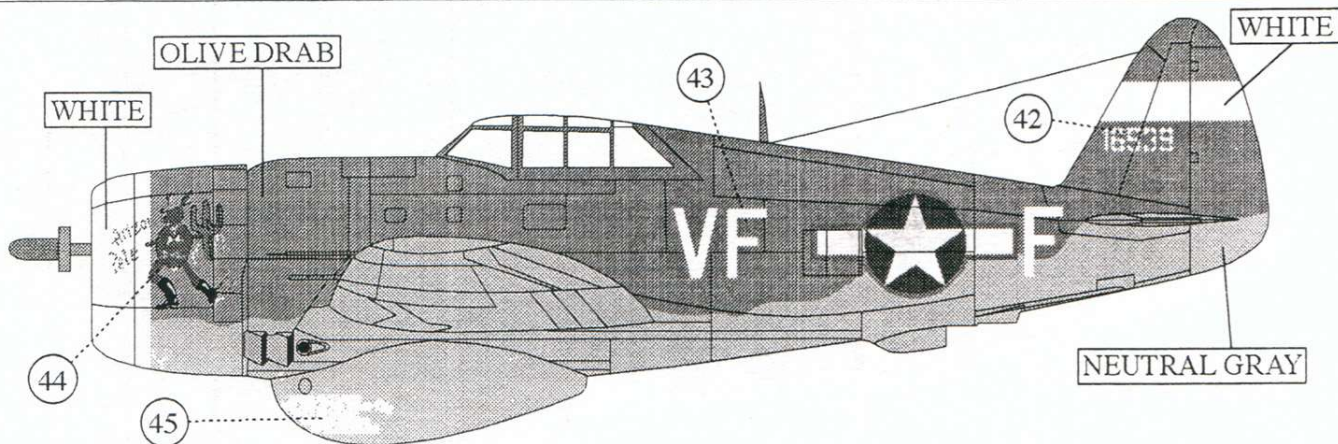

P 47 C, Capt.Kenneth PETERSON ,336th FS-4th FG, 1943

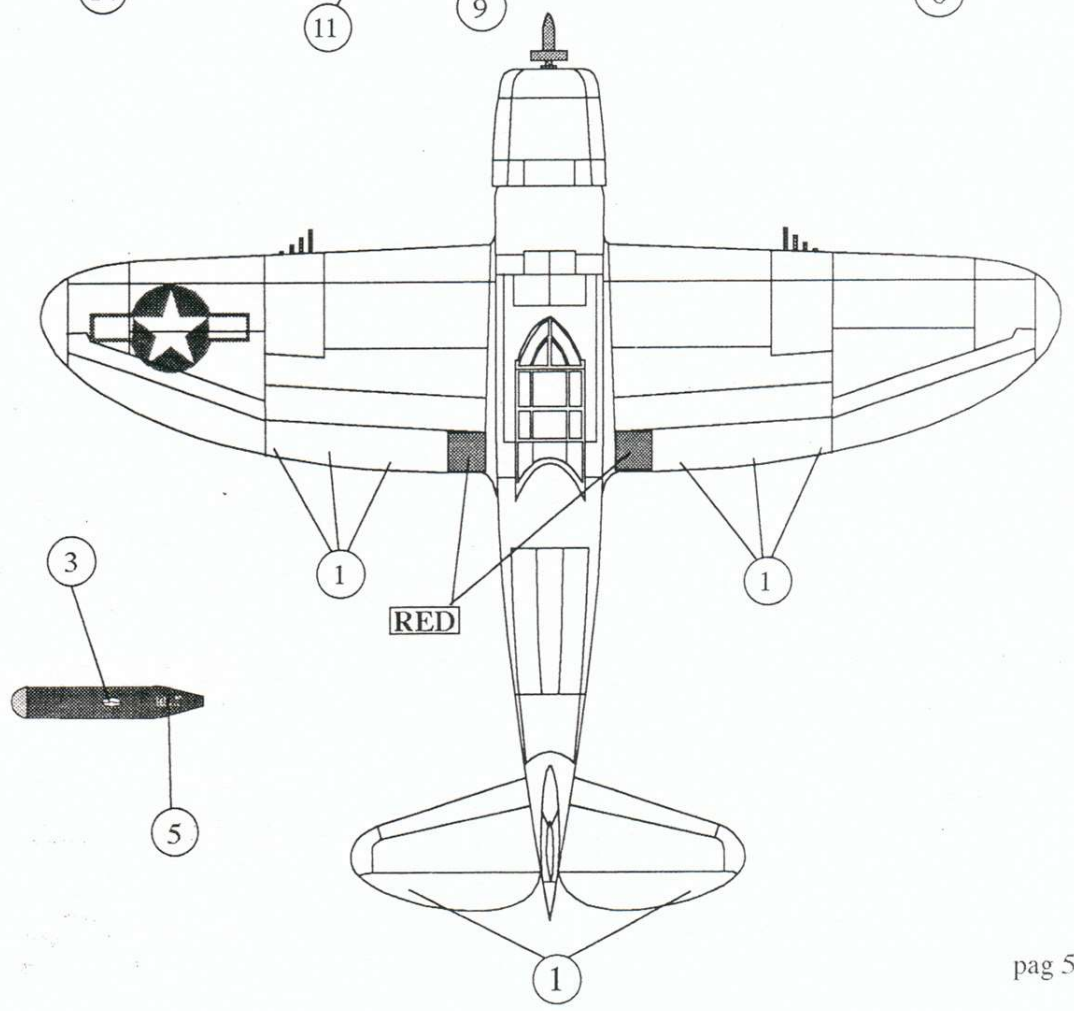
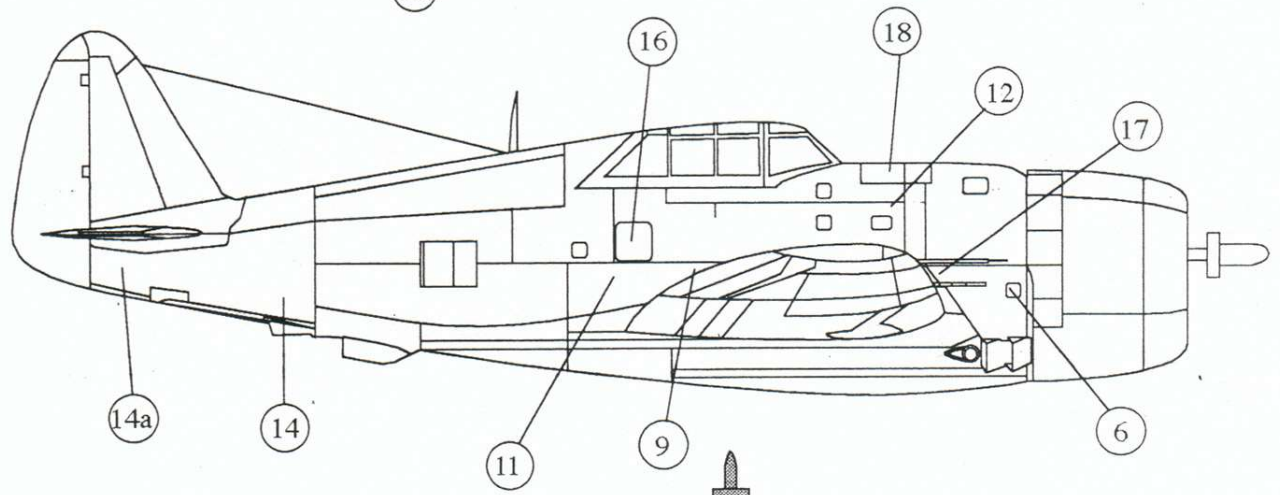
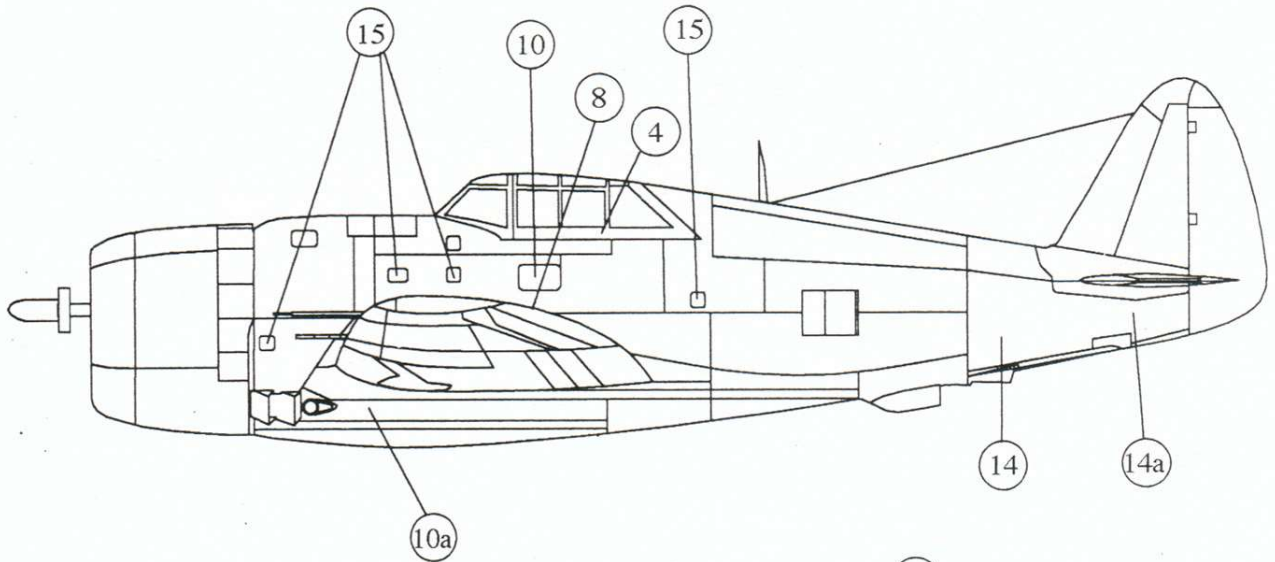

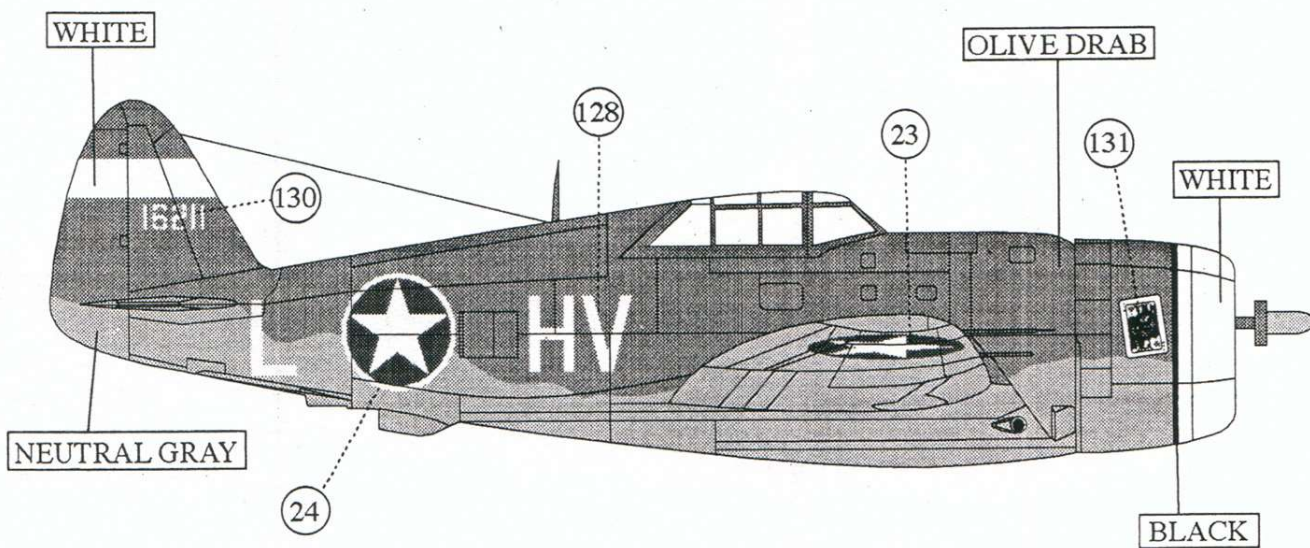
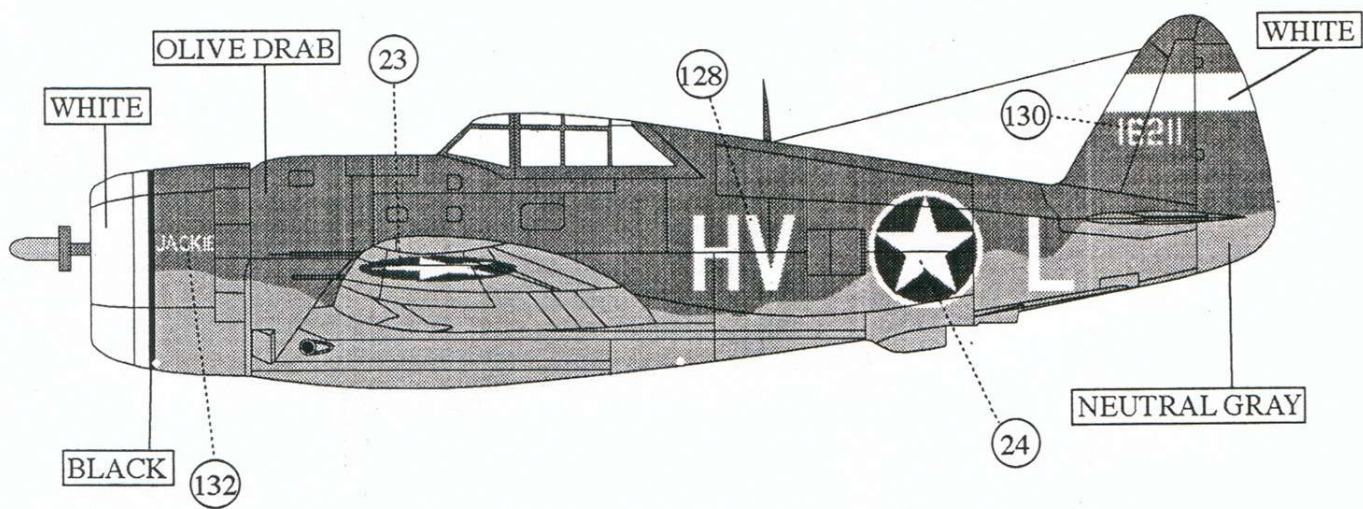

P 47 C-2, Capt.R.LAMB (7 kills), 61st FS-56th FG,Halesworth, August 1943

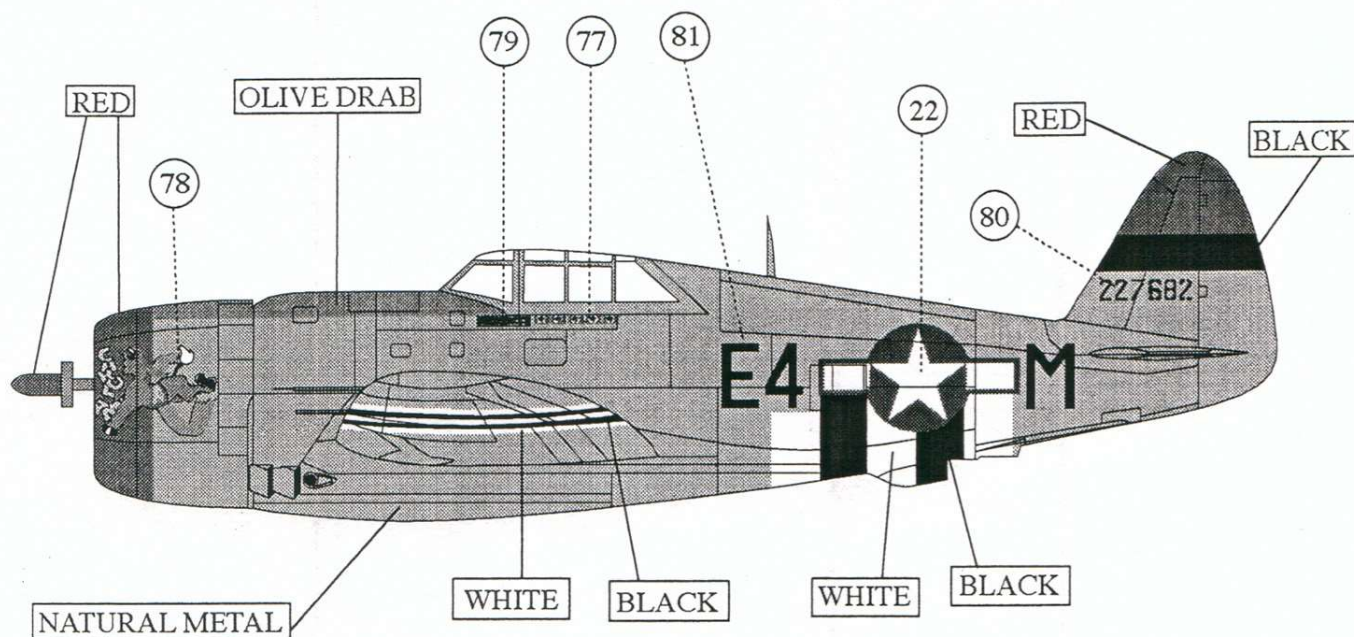

P 47 D-23, Col. Morton MAGOFFIN, -5 scores- CO 362nd FG, Rennes, France, August 1944

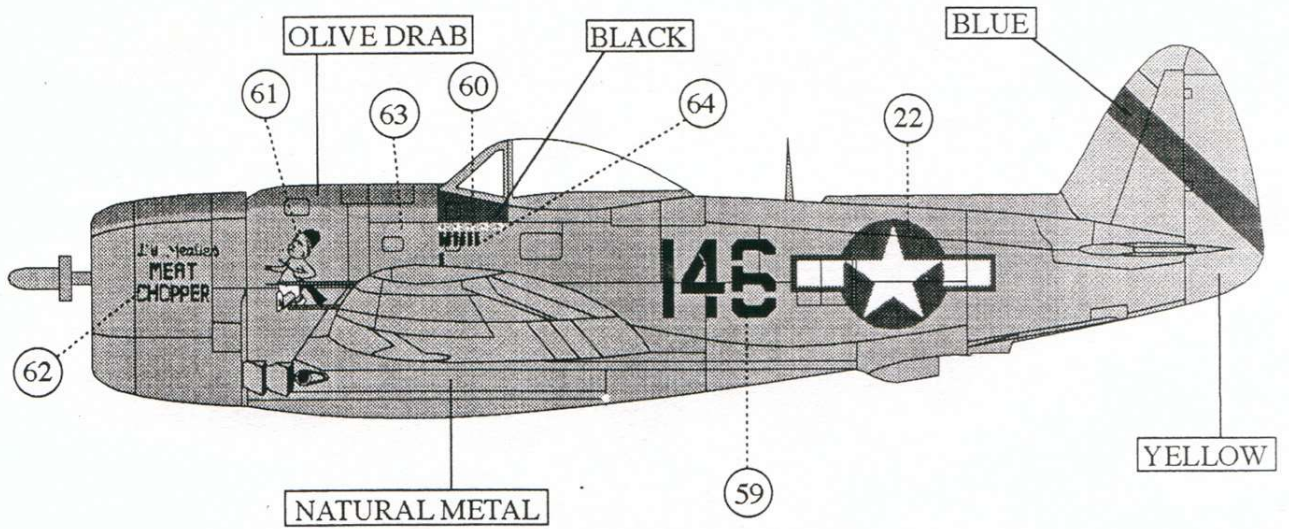

P 47 N-1, Lt. Oscar PERDOMO, -5 scores - 464th FS-507th FG, Le Shima, August 1945

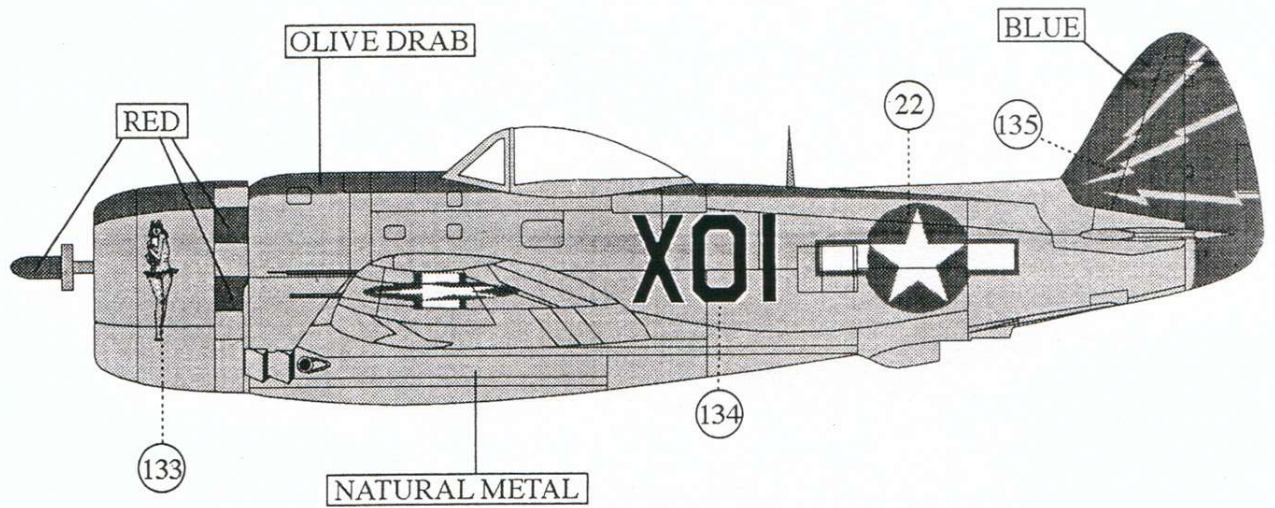

P 47 D, 86th FS, 79th FG, 12th AF, Italy, 1945

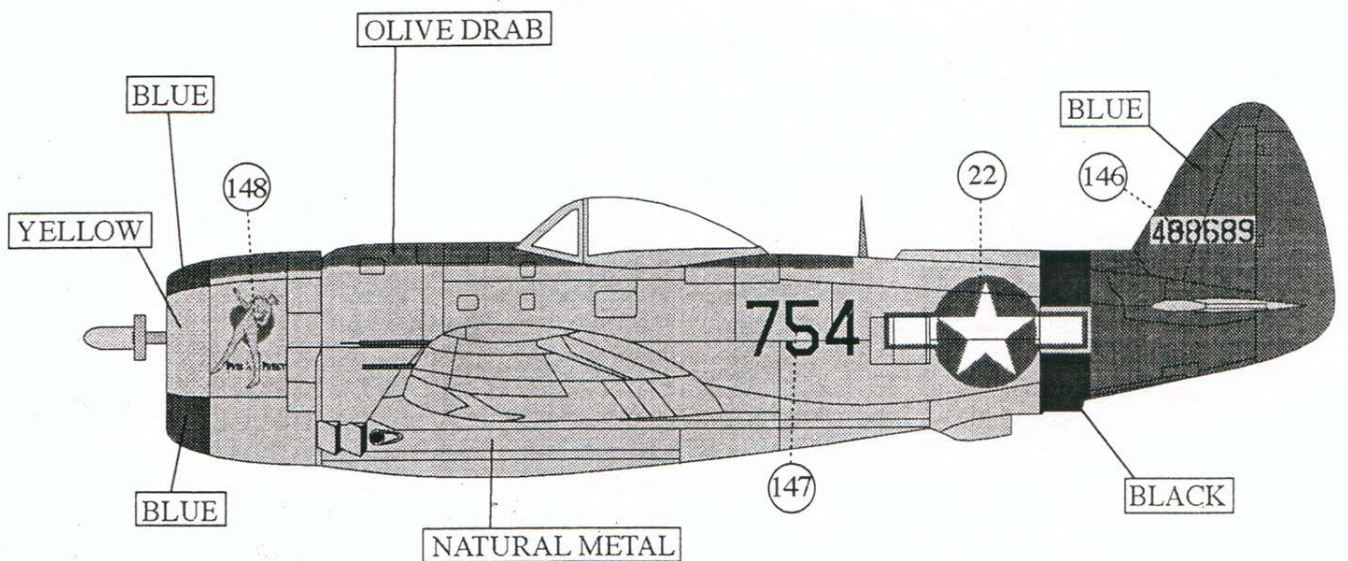

P 47 N, 456th FS-414th FG, Iwo Jima, 1945

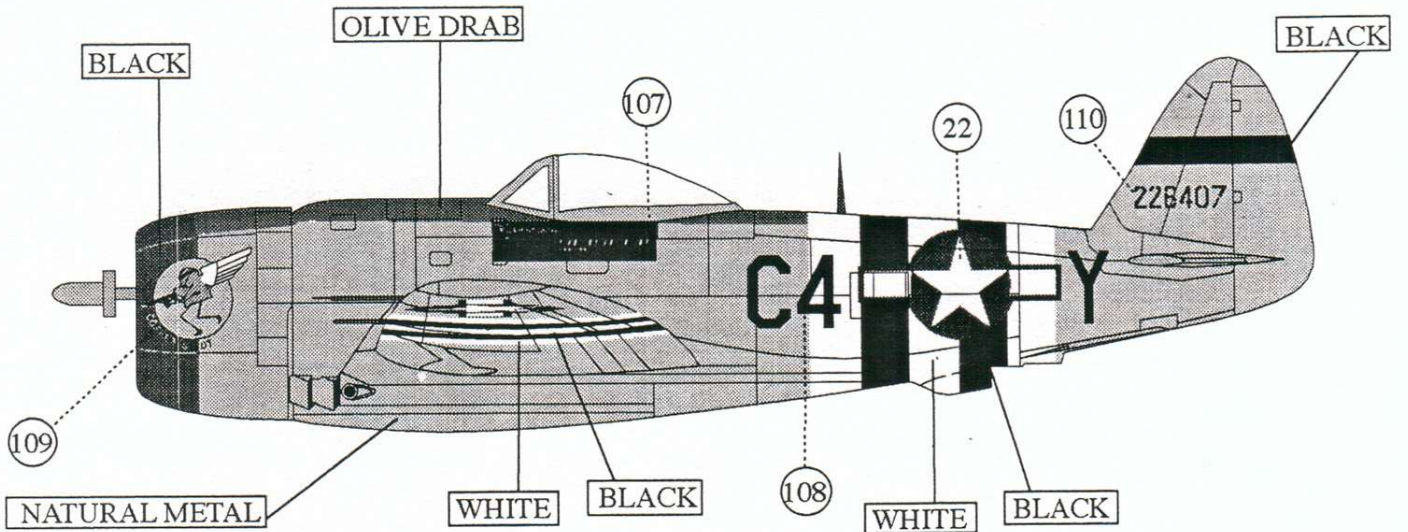

P 47 D-25, 365th FG, Lt.Col.R.COFFEY (6 kills),Azeville (A-7),France,July 1944

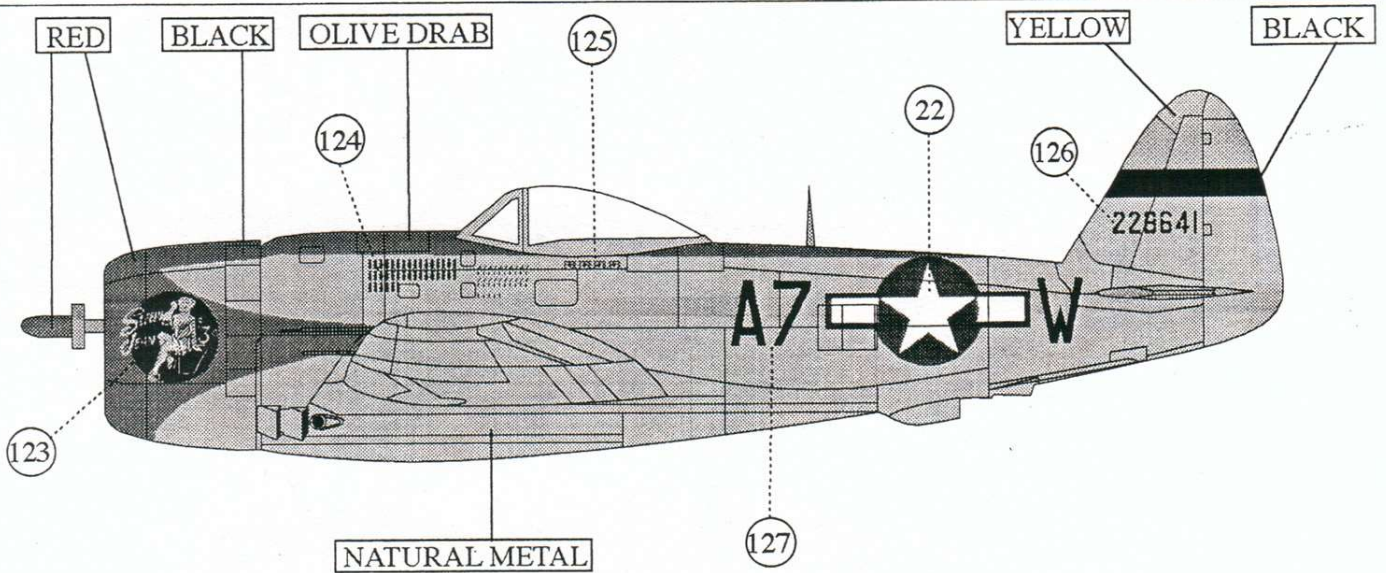

P 47 D-28,- 395th FS-368th FG, St.Dizier (A-64),France, May 1945

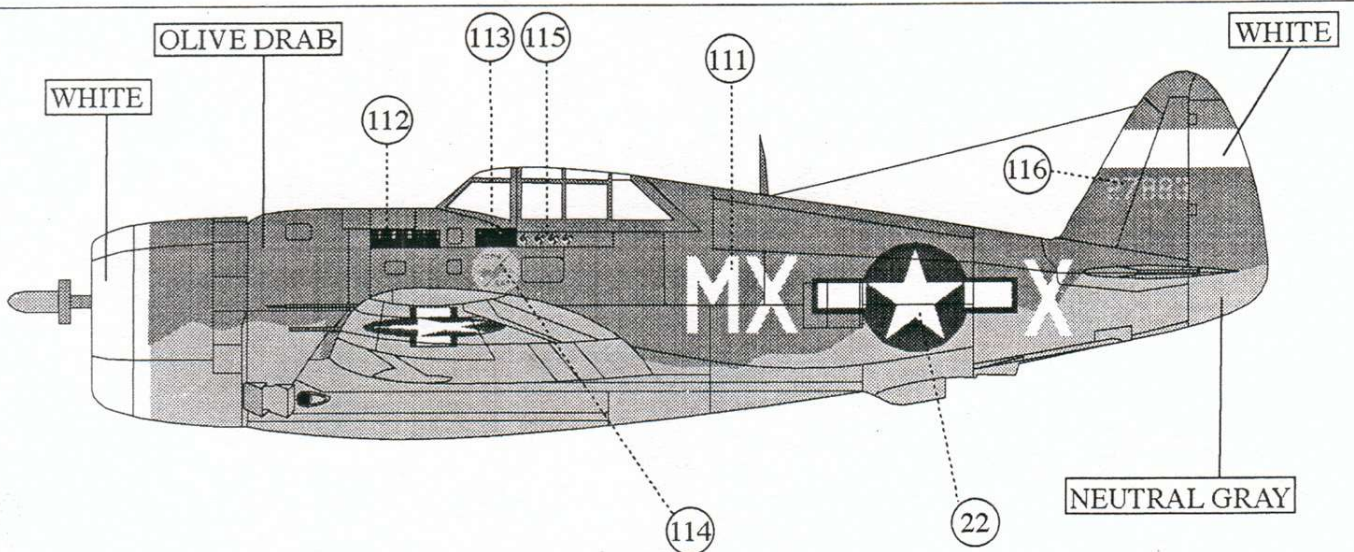

P 47 D-1, Maj.J.OBERHANSLY (6 kills) 82nd FS-78th FG,Duxford, December 1943

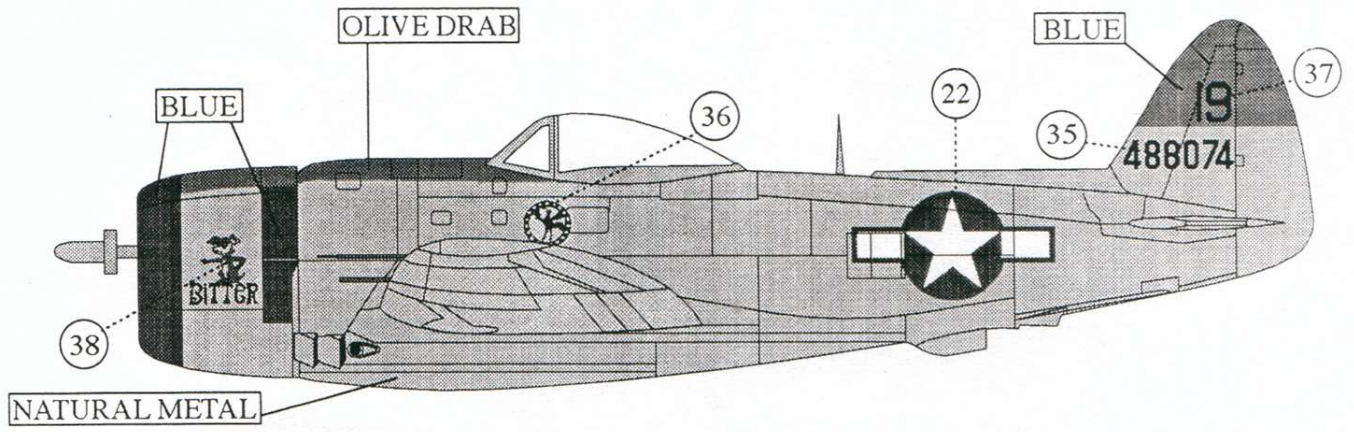

P 47 N, 19th FS-319th FG, Saipan, 1945

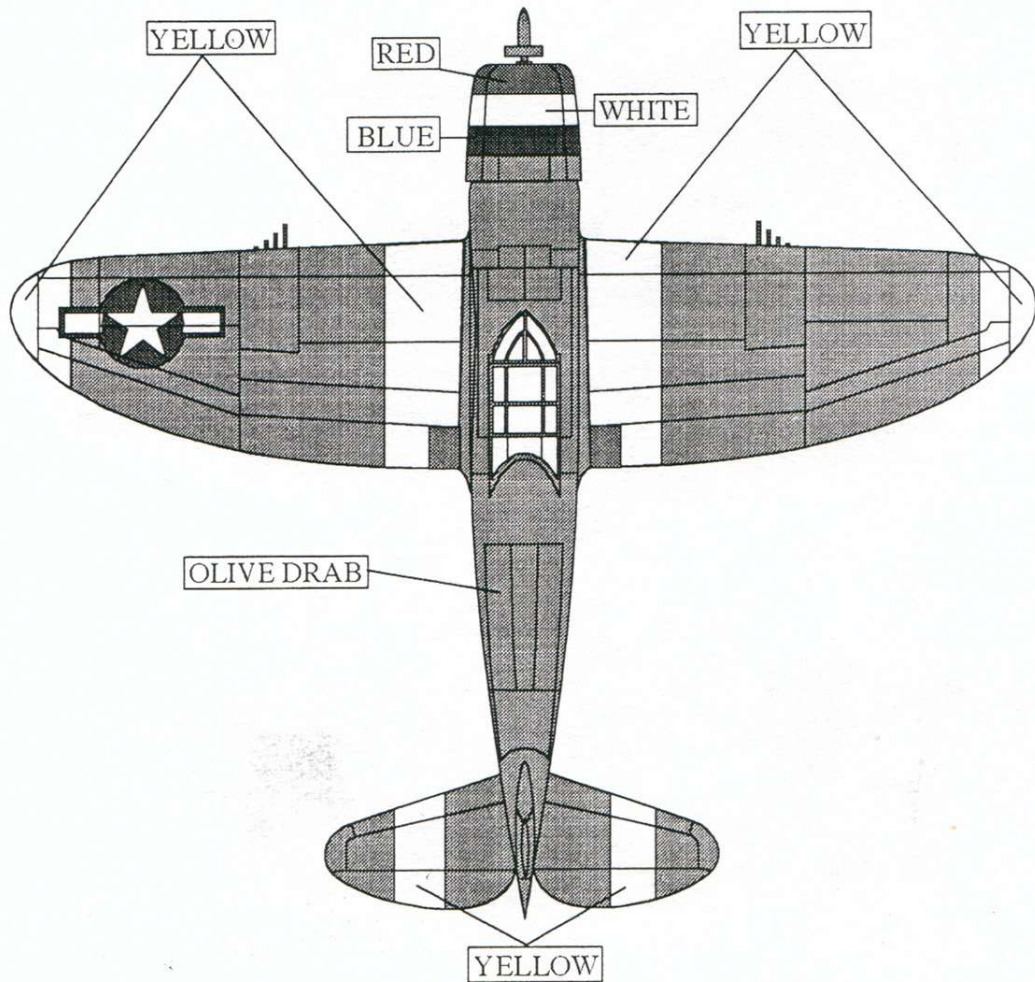
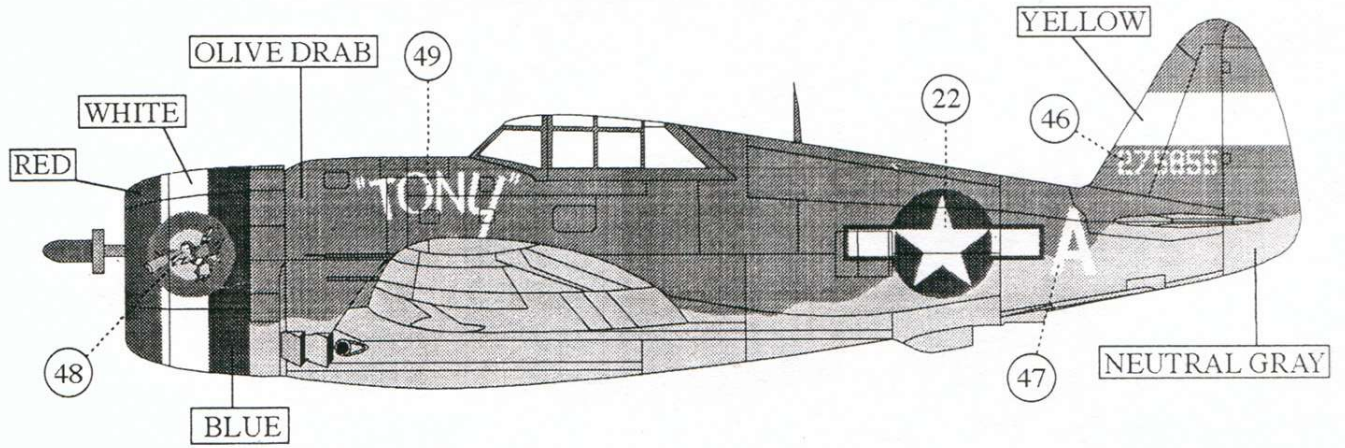

P 47 C, 5th Emergency Rescue Squadron

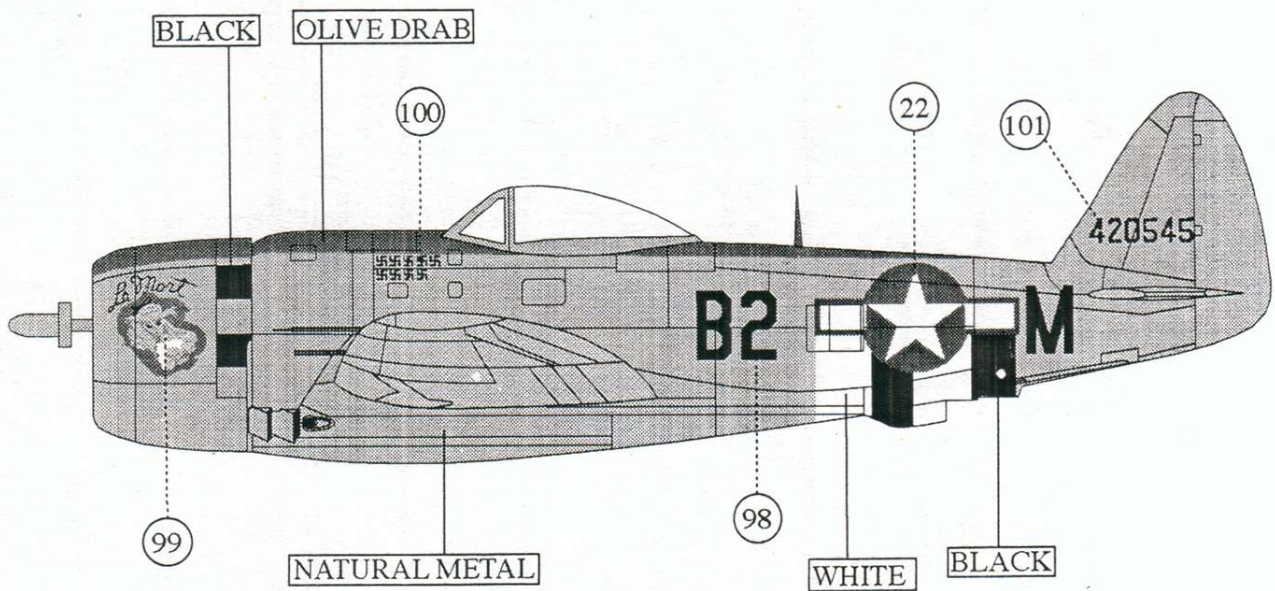

P 47 D-30, 1st Lt.Melvyn R.PAISLEY,-7 scores- 390th FS-366th FG,Handorf,Germany,May 1945

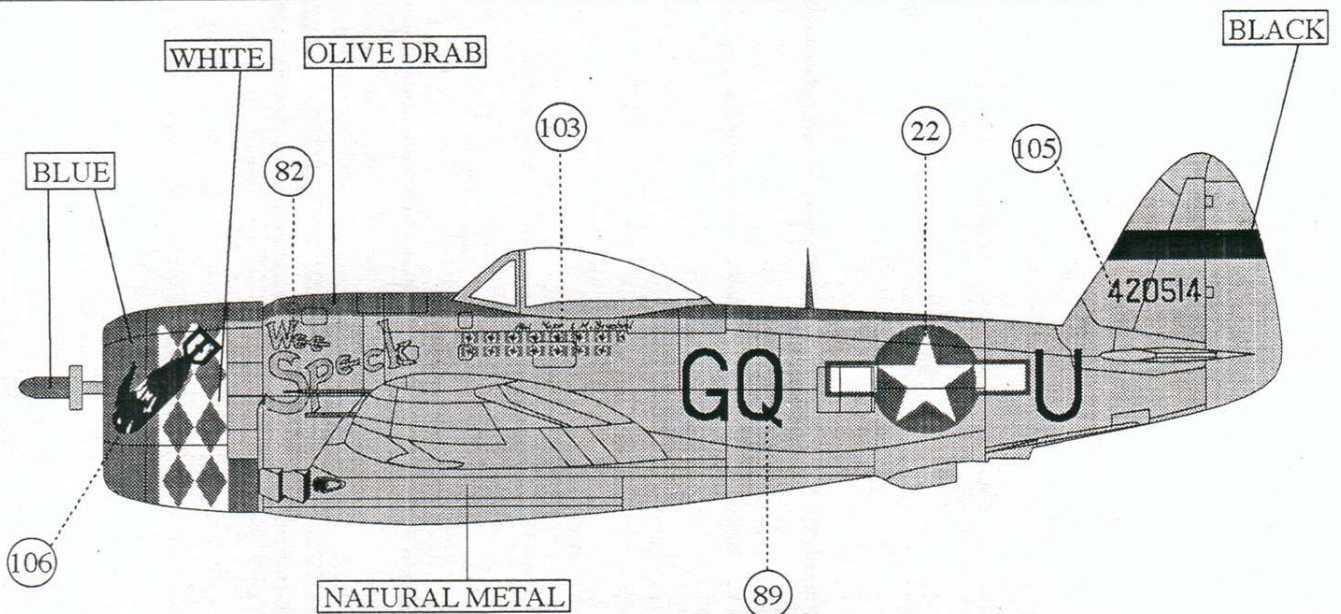

P 47 D-30, Capt.Lowell K.BRUELAND, -14.5 scores-355th FS-354th FG,Rosieres en Haye,France,December 1944

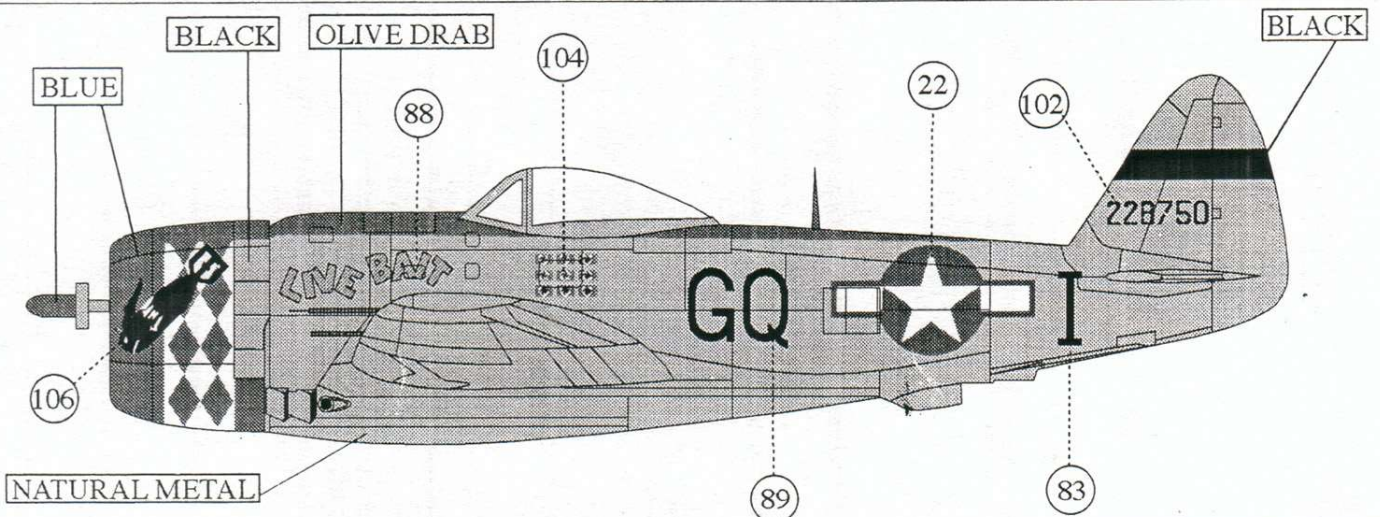

P 47 D-28, Capt.Clayton K.GROSS,- 9 scores- 355th FS-354th FG,Rosieres en Haye,France,December 1944

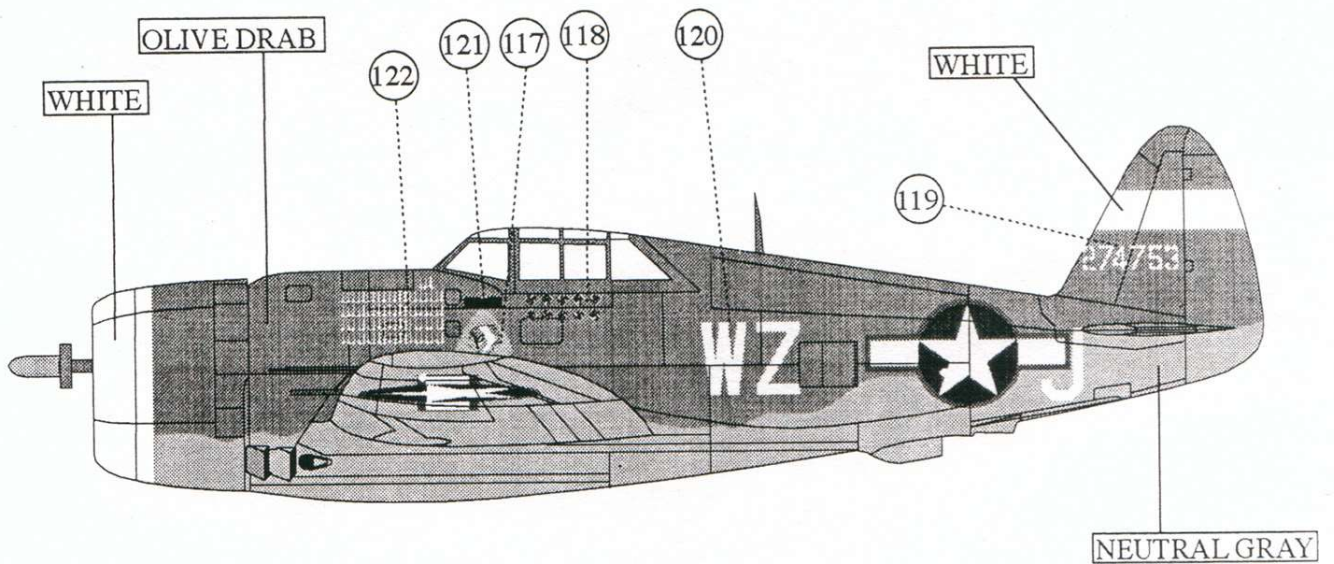

P 47 D-6, 42-74753, Lt Q. BROWN (12 kills)-84st FS-78th FG, Duxford, March 1944

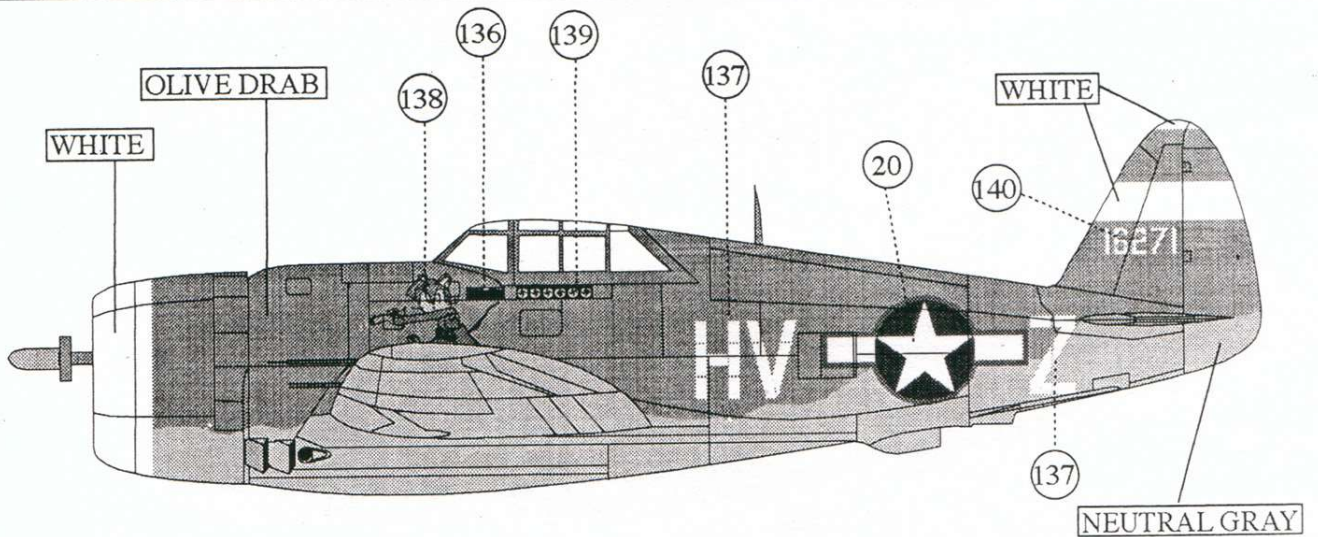

P 47 C-2, Lt F. McCauley (6 kills)-61st FS-56th FG, Halesworth, October 1943

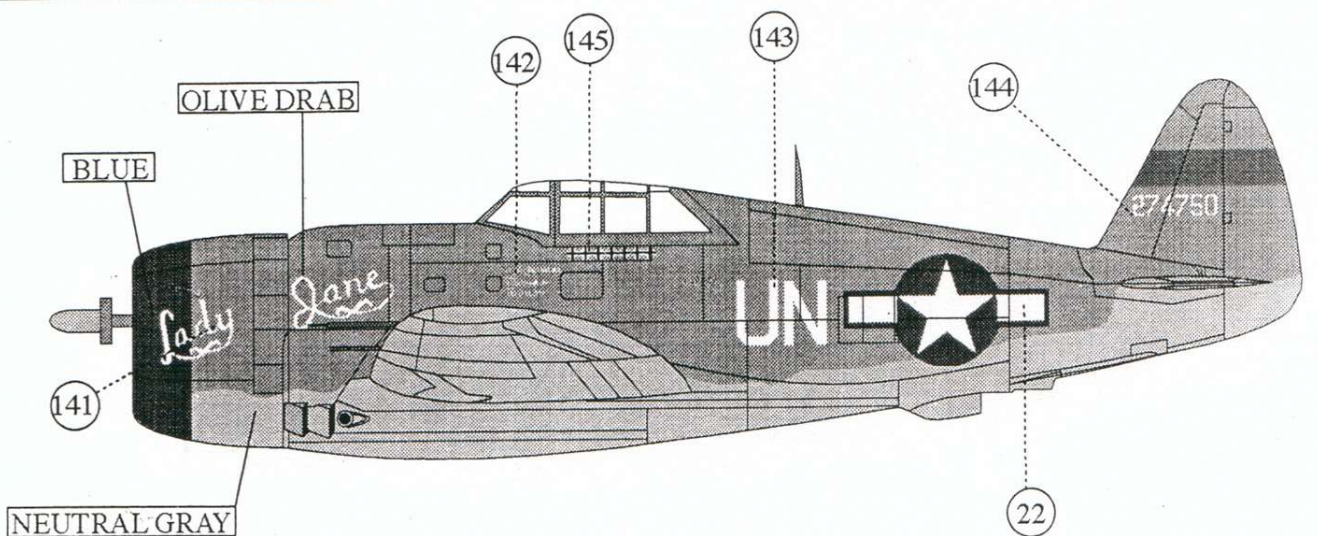

P 47 D-6, Lt J. Truluck (7 kills)-63rd FS-56th FG, Halesworth, March 1944

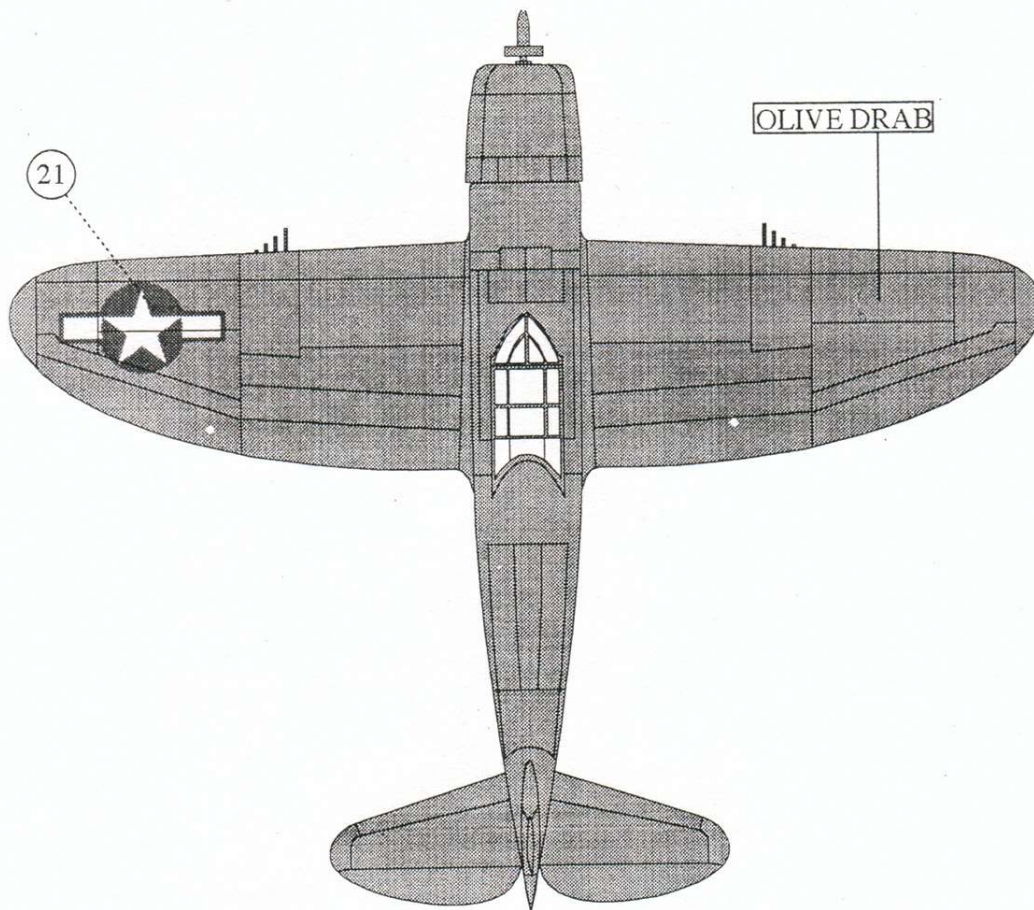

SOURCES

FIGHTER COMMAND, of J.L.Ethell and R.T.Sand, Motorbooks International; - AIR FORCE COLORS volume 2 & 3, Squadron Signal Publications; - P 47 THUNDERBOLT IN ACTION, Squadron Signal Publications; - THE NINTH AIR FORCE IN COLOUR, OF R.A.Freeman, Arms and Armour; - P 47 Thunderbolt, Profile Publications; - 56TH FIGHTER GROUP, of L.Davis, Squadron P.; - P 47 THUNDERBOLT WALK AROUND, Squadron Signal; - U.S.ARMY AIR FORCES IN THE PACIFIC, Aero Pictorials 2; - P 47 ACES of the Eighth Air Force, Osprey n.24; - P 47 ACES of the Ninth and Fifteenth Air Forces, Osprey N.30; - Mustang and THUNDERBOLT ACES of the Pacific and CBI, Osprey n. 26; - REPLIC, various number; - SAM, various number; - P 47 THUNDERBOLT, Burin do;

COLOUR GUIDE

COLOUR	FS 595 B	HUMBROL	MOLAK	TAMIYA	GUNZEM	MODEL M
OLIVE DRAB	34088	155 F	34087 F	XF 62	304 SG	1711 F
NEUTRAL GRAY	36173	27 F	36173 F	+XF54	13 SG	
BLACK	37038	33 F	2M	XF 1	33 F	1749 F
INSIGNA RED	31136	+ 153 F	+M 7 F	XF 7	413 F	1705 F
INSIGNA WHITE	37875	34 F	1 M	XF 2	62 F	1768 F
INSIGNA BLUE	35044	189 F	35044 F	+ X 3	326	1719 F
IDENT YELLOW	33538	154 F	33538 F	X 19	329	1708 F