

# German 88 mm KwK 43/2 L/71 Tiger B Porsche - Turm Early Barrel

(Lufa do czołgu Tiger II z wczesnej produkcji- wieża Porsche)

1/35 scale update fit to Tamiya model

## ABER®

## 35 L-13n

WWW.ABER.NET.PL

Made in Poland © 2017

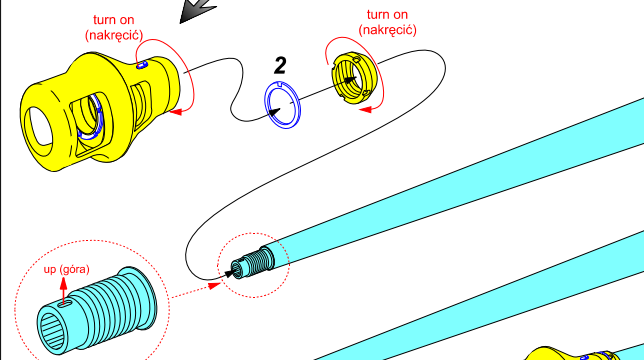
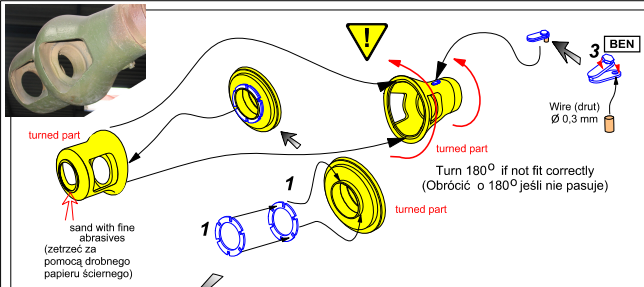
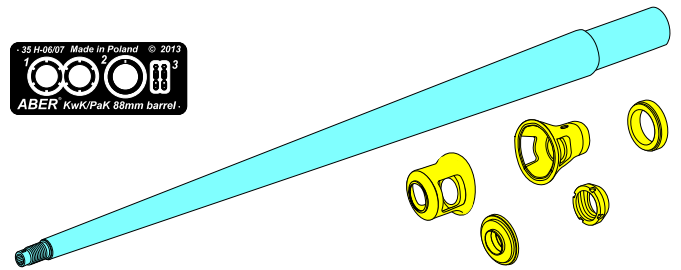

Please note that, for purpose of improvement ABER sets designs are subjects to change without notice. Proszę mieć na uwadze fakt, że zestawy ABER mogą ulec zmianie ze względu na ulepszenia, bez powiadomienia.



We advise that better method to join metal to metal is soldering. Use ABER soldering solution AF20 (doradzamy łączenie części metalowych za pomocą lutowni. Zastosuj nasz topnik AF20)

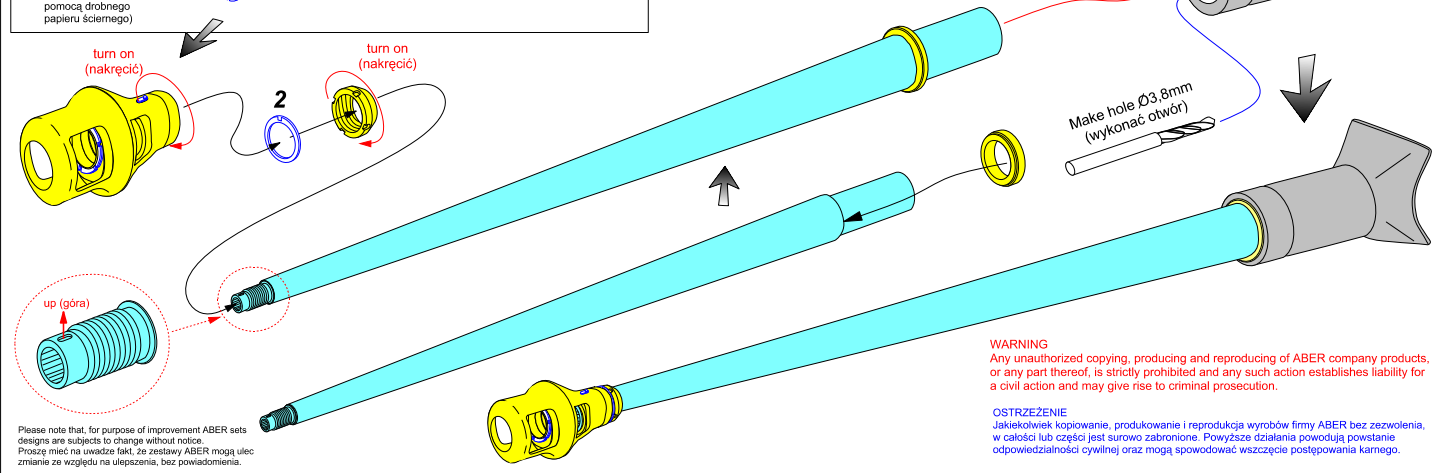

or old version

# German 88 mm KwK 43/2 L/71 Tiger B Porsche - Turm Early Barrel

(Lufa do czołgu Tiger II z wczesnej produkcji- wieża Porsche)

1/35 scale update fit to Tamiya model

NEW GENERATION set

## ABER®

## 35 L-13n

WWW.ABER.NET.PL

Made in Poland © 2014

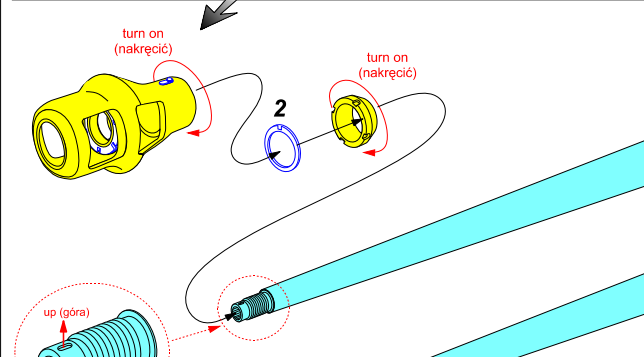
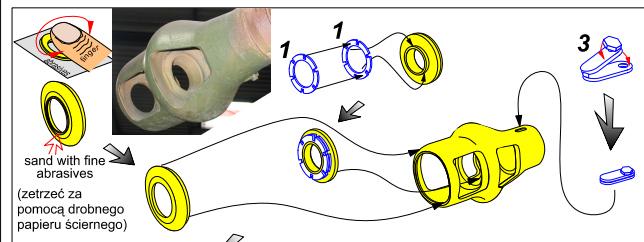
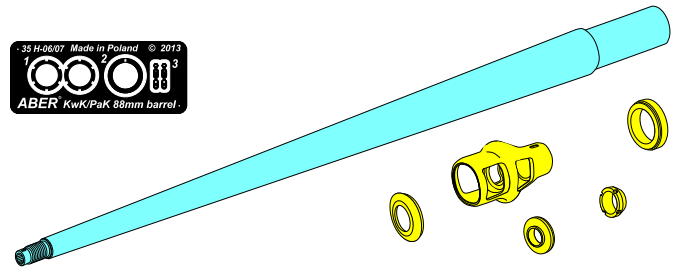

Please note that, for purpose of improvement ABER sets designs are subjects to change without notice. Proszę mieć na uwadze fakt, że zestawy ABER mogą ulec zmianie ze względu na ulepszenia, bez powiadomienia.



We advise that better method to join metal to metal is soldering. Use ABER soldering solution AF20 (doradzamy łączenie części metalowych za pomocą lutowni. Zastosuj nasz topnik AF20)

