

[*AirDOC*]

Aircraft Documentations

Luftwaffe RF-4E Phantom II - Part 2 Stencils and Walkways for Norm 72 Camouflage



RF-4E Phantom II

Instructions for
ADS 173003/149003/133002

Please read before you begin!!

The external fuel tank pylon attachment points are not positioned correctly in the Hasegawa kit.

In order to perfectly apply the decals to the lower wing surfaces it is required to relocate the holes.

The actual distance between the wingfold and the pylon attachment axis of a RF-4E is 70 cm. This is translated in 1:48 scale to 14.6 mm. In the Hasegawa kits the distance is only 11.9 mm. It is therefore necessary to seal the existing holes and to drill new ones 2.7 mm inwards, towards the centre fuselage.



Bottom

Top

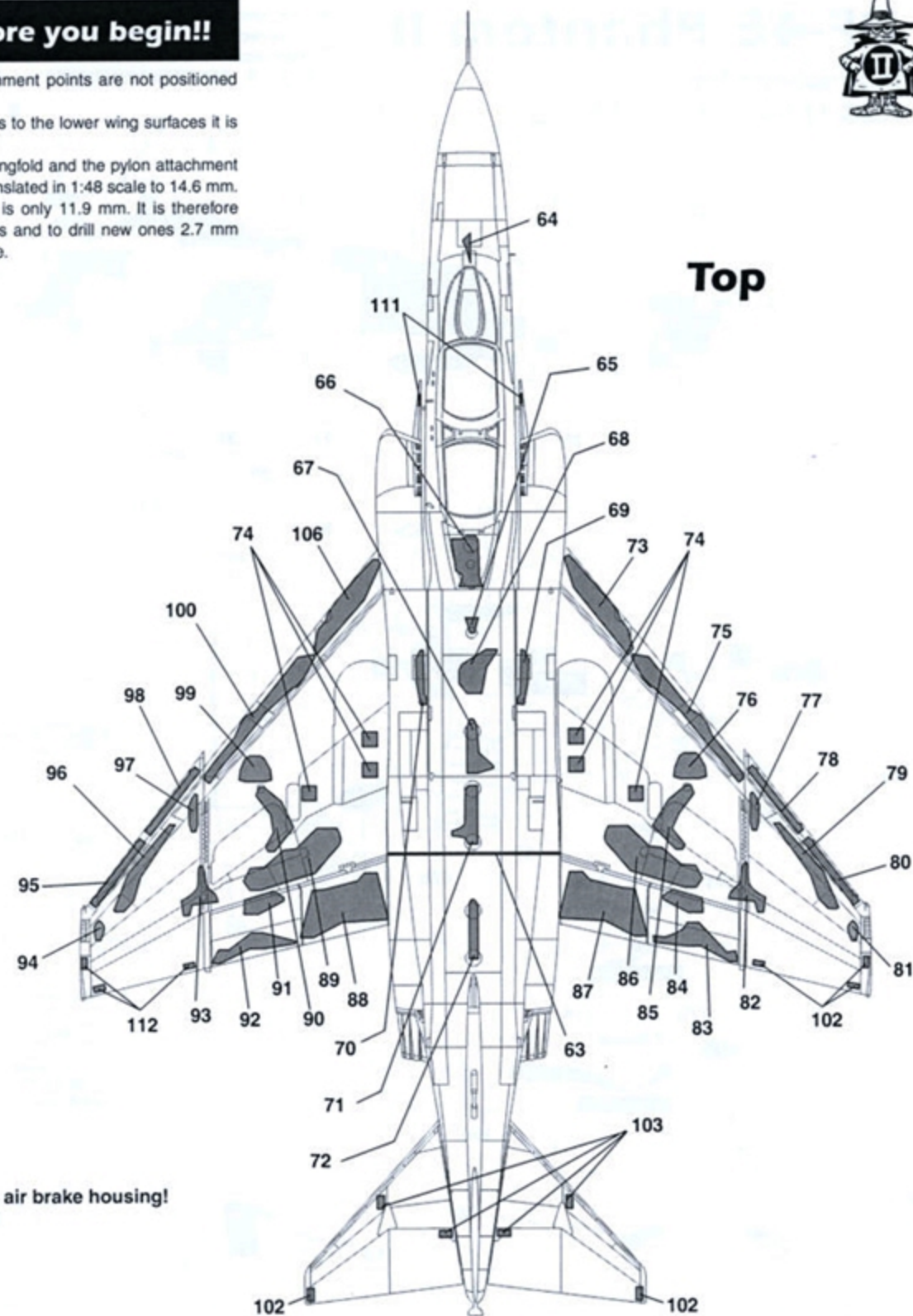
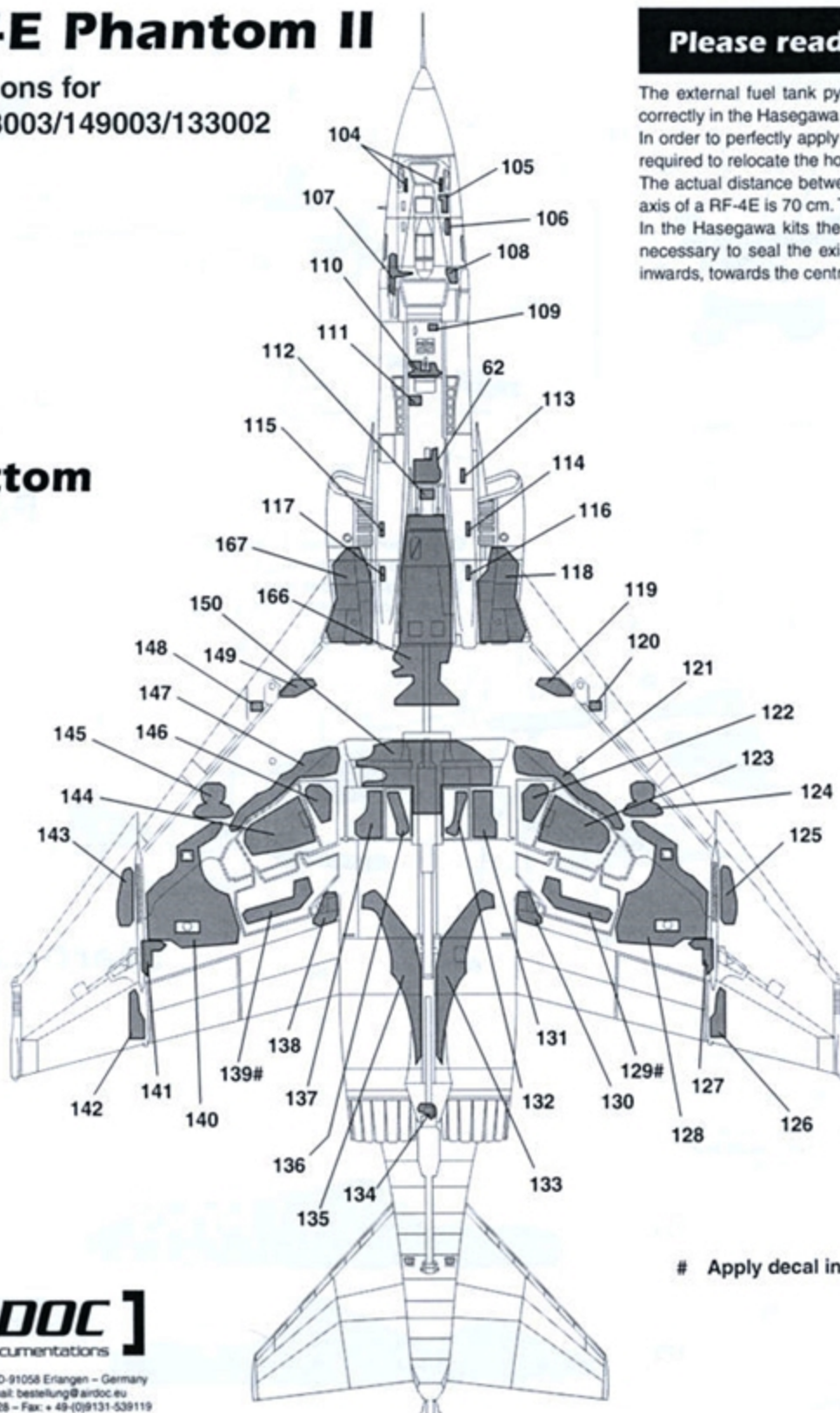

Apply decal inside the air brake housing!

[AirDOC]
Aircraft Documentations

Am Weichselgarten 5 - D-91058 Erlangen - Germany
www.airdoc.eu - email: bestellung@airdoc.eu
Phone: +49-(0)9131-52828 - Fax: +49-(0)9131-539119

RF-4E Phantom II

Instructions for
ADS 173003/149003/133002

Check your references. For certain aircraft it might be necessary to cut the rescue arrow from decal 4 and to replace it with decal "F1/F2" of ADM 72018/48018/32012

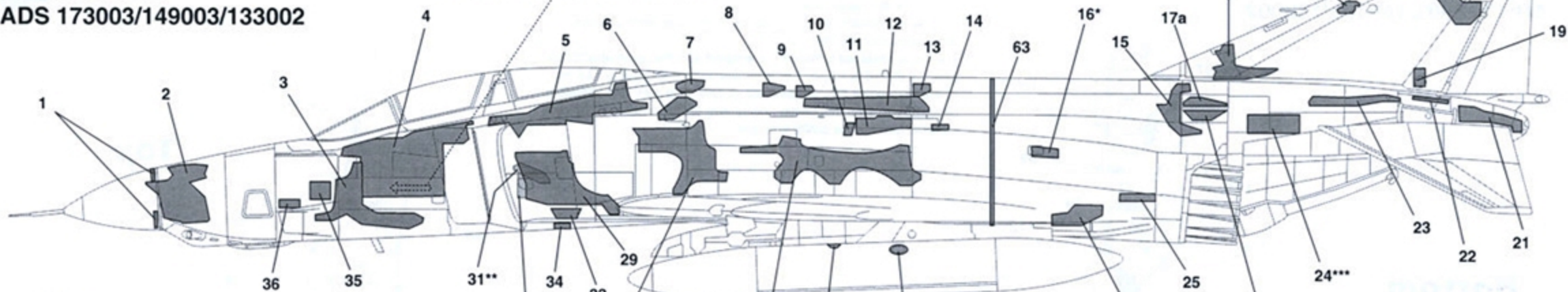

Port

Check your references. For certain aircraft it might be necessary to cut the rescue box from decal 42 and to replace it with decal "P" of ADM 72018/48018/32012

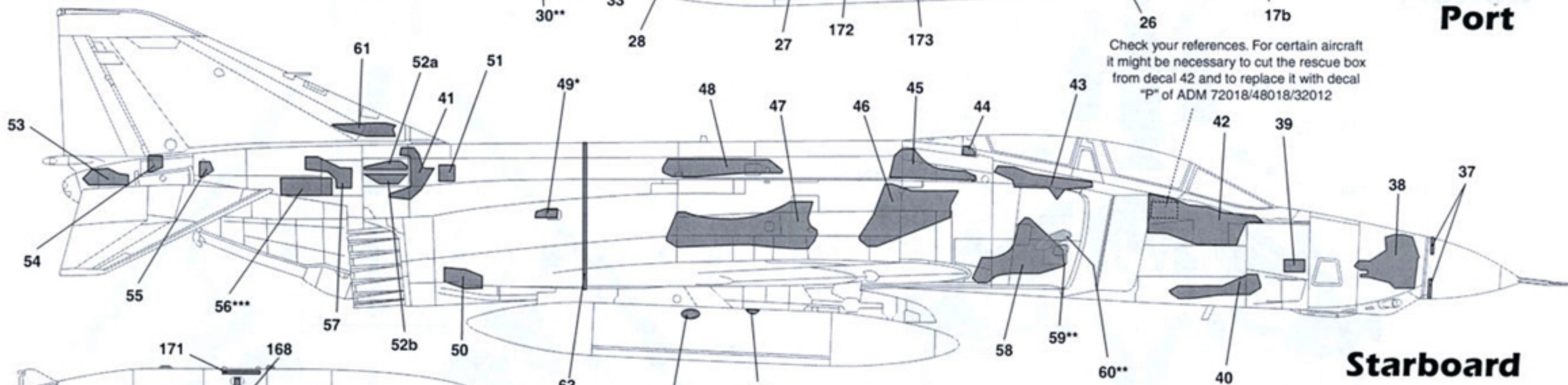

Starboard

• Apply decal "16" and "49" on top of "Iron Cross"!

** See details at the bottom of the page

*** Prior to application of decal "24" and "56" of ADS 173002/149002/133001 check if your favorite bird needs decal "G" of ADM 72018/48018/32012

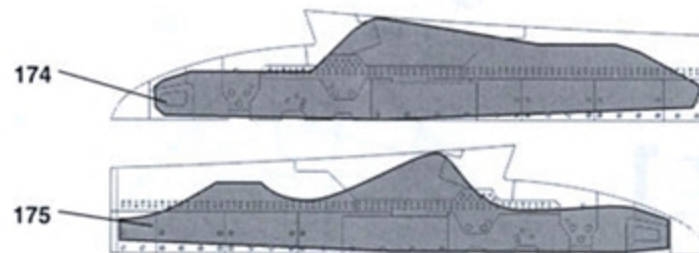
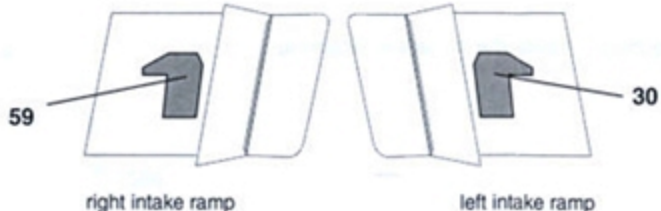
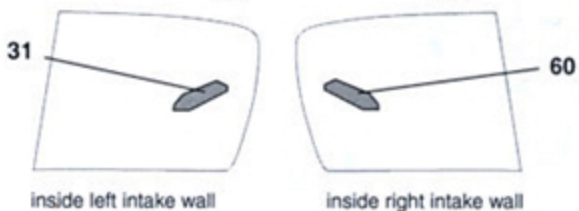

Inboard wing pylons, right & left.

Instructions

This AirDOC decal set allows you to outfit one Luftwaffe RF-4E Phantom II aircraft with the complete stencils of the Norm 72 camouflage worn by the aircraft during the 1970s and early 1980s.

Decal application:

To apply the decals cut each subject carefully from the backing paper. Do not cut away the excess film. Dip the decal for about 20 seconds into water and wait until it slides easily on the backing paper. Do not pull or push the decals before the adhesive has completely dissolved, otherwise it might be ruined. You may use a setting solution but this is not necessary. After the decal is applied to the model's surface, wait several hours until it has set and dried properly. Do Not Touch It Prior!! Depending on the surface's quality, a gloss varnish should be sprayed onto the model prior to the application of the decals, thus, the clear excess film will disappear completely.
Happy Decaling!

Kit suggestions to build a correct Luftwaffe RF-4E Phantom II:

1. 1/72 scale – Revell 04313 RF-4E Phantom II „Tiger Meet“
2. 1/48 scale – Hasegawa PT-31 RF-4B or PT-32 RF-4C which both form a perfect basis for a good RF-4E or PT-33 RF-4E
3. 1/32 scale – Tamyia F-4EJ (Black Box CS 32004 needed)

In our opinion the following update kits are a must have for the serious modeler:

Aires:

- 7072 F-4F or 7128 F-4E/EJ/G/J/S nozzles in 1/72 scale
- 4123 F-4 wheel bays in 1/48 scale
- 4118 F-4E/EJ/F/G/J/S nozzles in 1/48 scale
- 4231 RF-4B/C/E camera bay
- 4330 RF-4B/C/E detail set (includes camera bay, wheel wells, cockpit and nozzles)
- 2009 F-4E/EJ/F/G/J/S nozzles in 1/32 scale

AirDOC:

- ADR 48002 correct 600gal HPC centerline tank
- ADR 48003 USAF style engraved under wing pylons and missile rails (AERO 3B and LAU-7) with chaff/flare dispensers
- ADR 48010 unslotted stabilators (for Hasegawa/Revell)
- ADS 173003/149003/133002 stencils for RF-4E aircraft in Norm 72 camouflage

Black Box:

- CS 32004 RF-4E nose conversion

Meteor Productions:

- CEC 32035 USAF slightly bulged tires

For further reference see our publication:

Modern Combat Aircraft Special Series ADPS 007

- MDD F-4 Phantom II – 50th Anniversary
- Pictorial Luftwaffe PHANTOMS – Norm 72 Camouflage
- ISBN 3-935687-12-5

Size A-4, 72 pages, soft cover, full color, English/German captions, over 160 pictures and unit insignia.

Our latest title is the first in a row of publications dedicated to the 50th Anniversary of the "Rhino" (1958–2008). Many of the aircraft depicted in our decal sheets ADM 72017/48017/32011 and ADM 72018/48018/32012 can be found in there. **This is a great source for the modeller!**

Retail price EURO 14.95 (postage not included)

Our thanks goes to Mr. Richard J. Caruana from Malta, for providing the basic art work to finish these instructions! <http://members.bell.net.mt/airart>



This set is for the experienced modeler only and should be kept out of reach of little children. Not suited for children under the age of 14!



Am Weichselgarten 5 - 91058 Erlangen - Germany - Phone +49-9131-401993
Fax: + 49-9131-539117 - E-mail: andreas Klein@airdoc.eu - All major credit cards accepted!