

648 442 M2 Browning w/handles

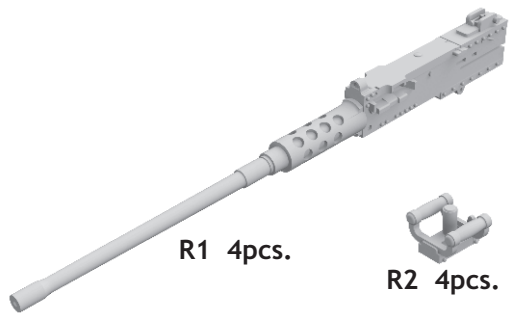

1/48 scale



R1 4pcs.

R2 4pcs.

R3 4pcs.

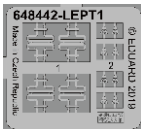

COLOURS

GSI Creos (GUNZE)		Mr.METAL COLOR	
AQUEOUS	Mr.COLOR	Mr.METAL COLOR	
H2	C2	MC214	DARK IRON
H37	C43		
	C92		

This product contains metal and resin detail parts for upgrading scale plastic models. When selecting this set make sure that it is for the kit mentioned in product name as these sets are made specifically for that kit. When upgrading the model some cutting or corrections may be necessary for parts to fit accurately. **WARNING!** This set contains small and sharp parts. Work carefully in a ventilated and well-lit room. Safety glasses are recommended. This product is not suitable for children below 14 years of age.

Tento výrobek obsahuje leptané a odlévané detaily pro úpravu a vylepšení plastického modelu. Při výběru sady kovových detailů zkontrolujte, zda je určena pro model, který chcete upravit. Model, pro který je sada určena, je uveden u názvu výrobku. Pro přesnou aplikaci kovových a odlévaných dílů může být zapotřebí upravit díly upraveného modelu. **POZOR!** Sada obsahuje malé ostré díly. Pracujte ve větrané a dobře osvětlené místnosti. Doporučujeme použití ochranných brýlí. Tento výrobek není vhodný pro děti mladší 14 let.



435 21 Obrnice 170
Czech Republic

www.eduard.com

14,95



648 442 M2 Browning w/handles

1/48







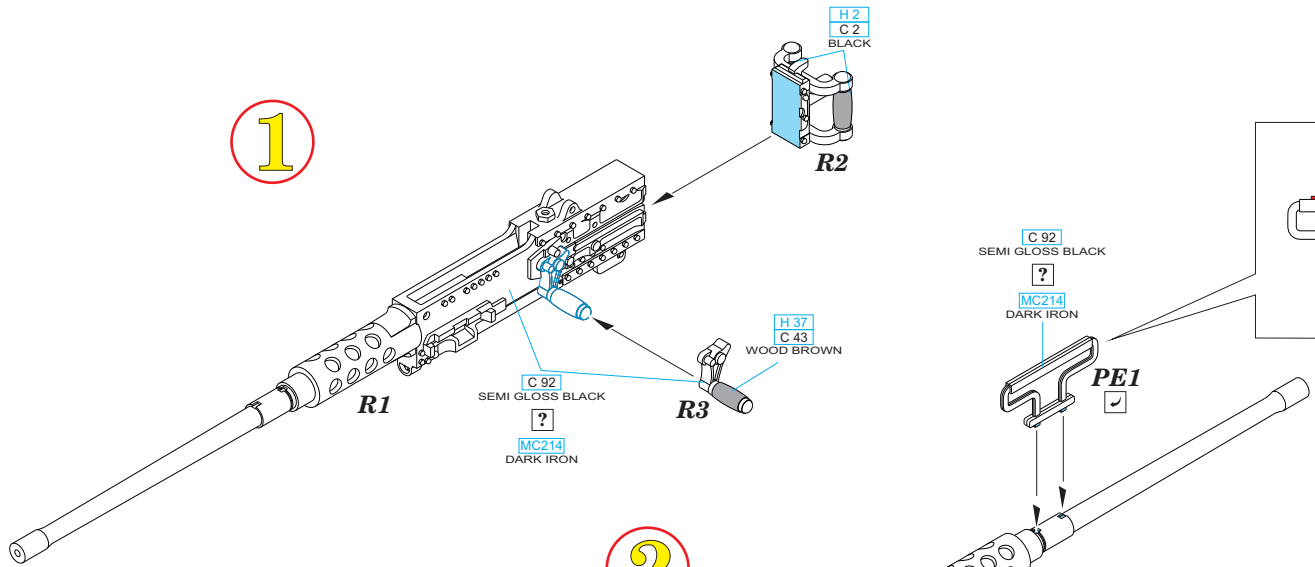



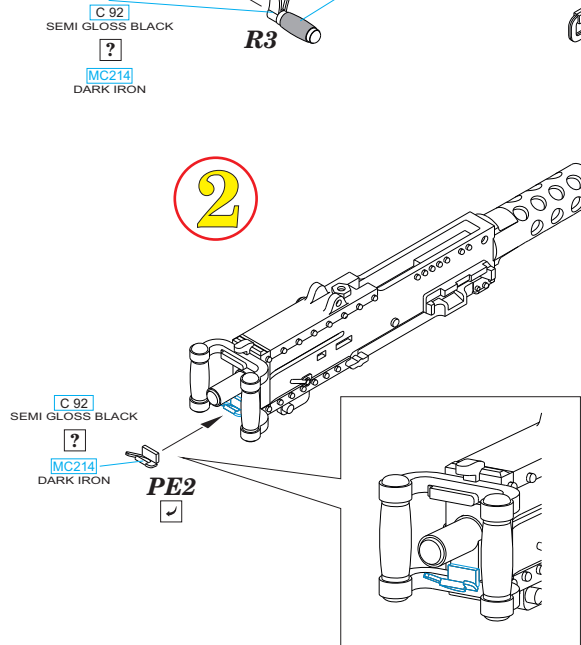

~~BEST BRASS~~ RESIN AROUND!

1



2



-  REMOVE
ODSTRANIT
-  GRIND
OBROUSIT
-  DRILL HOLE
VRTAT OTVOR
-  SYMMETRICAL ASSEMBLY
SYMETRICKA MONTAZ
-  SCRIBE THE PANEL AND HOLES
RYTI
-  REVERSE SIDE
OTOCT
-  BEND
OHNOUT
-  OPTION
VOLBA
-  REPLACE
NAHRADIT