

# DECAL INSTRUCTION

V1

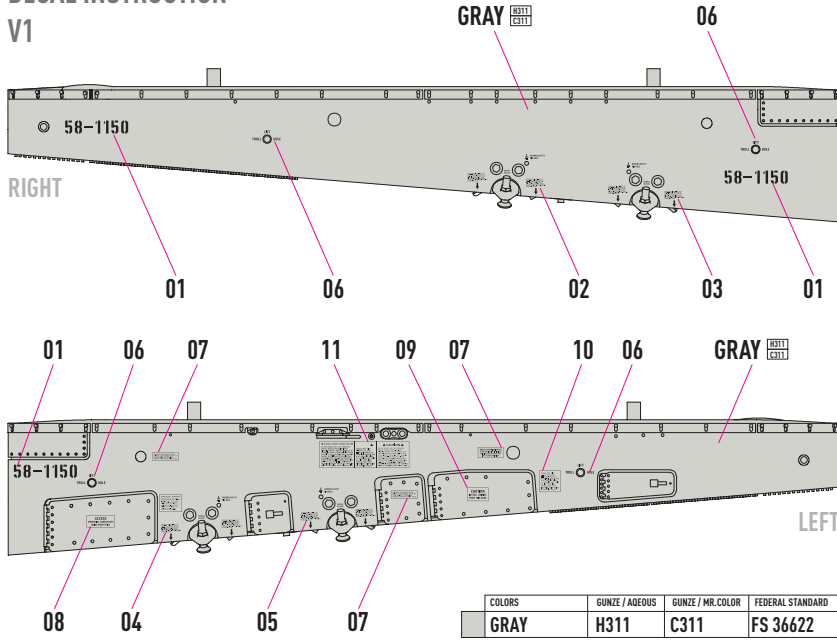

V2

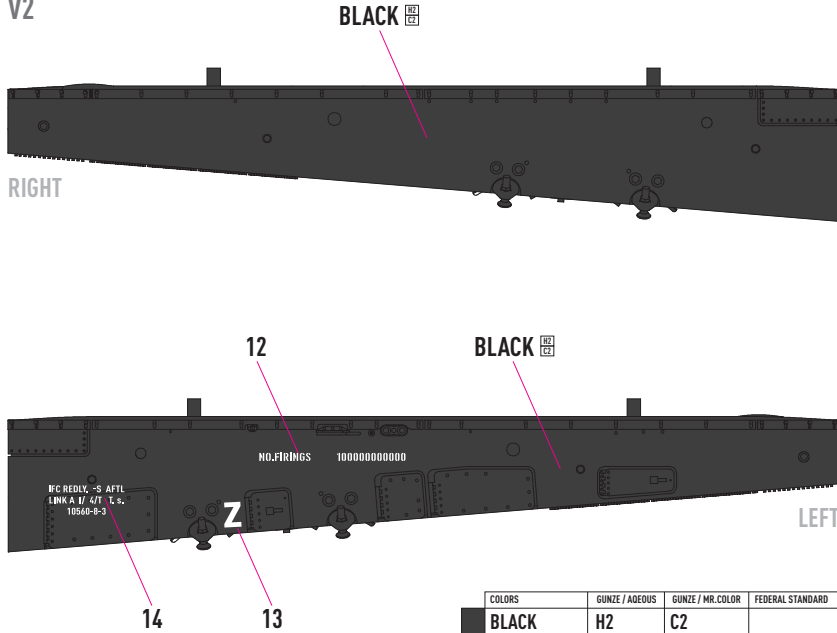

CUT

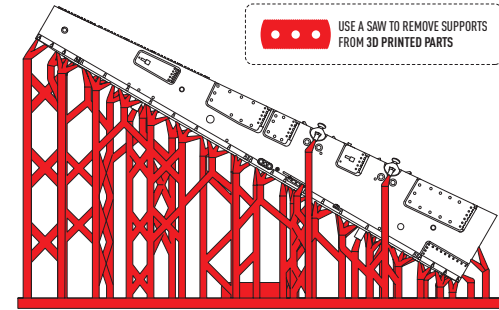

R1

1

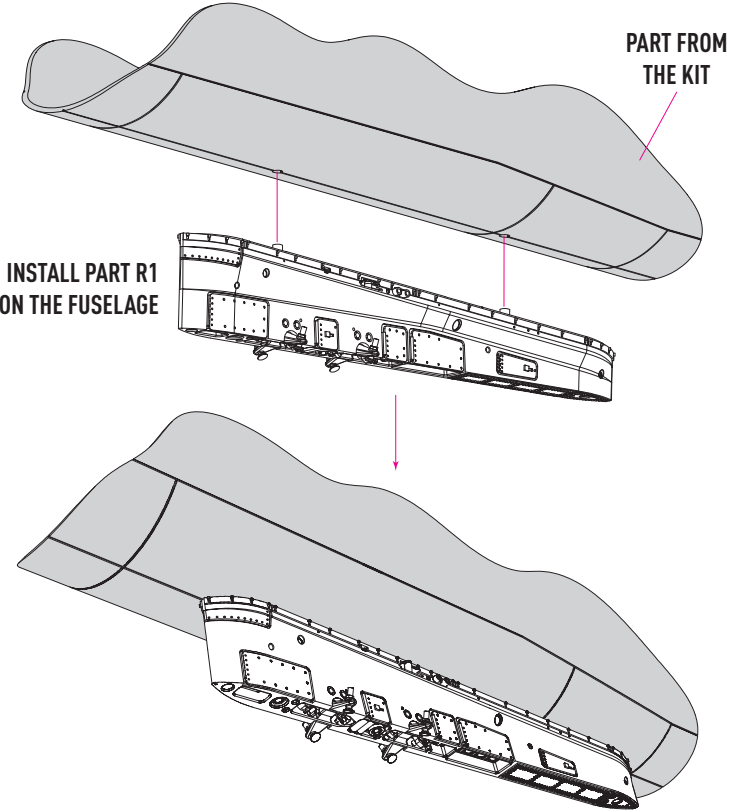

**2 FOR MODEL F105D**

FOR F105D, IT IS POSSIBLE TO INSTALL LININGS BETWEEN THE FUSELAGE AND THE PYLON THAT FIX THE BOMB BAY DOORS IN THE CLOSED POSITION

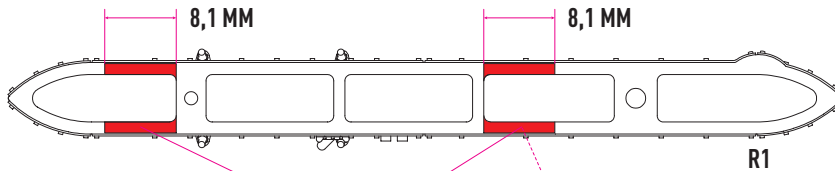

GRIND OFF INDENTATIONS  
8,1 MM WIDE AND 0,15 MM DEEP

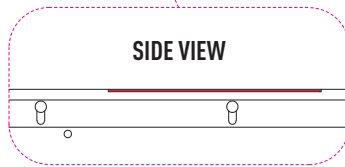
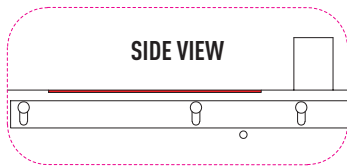

**3**

BEND PART P1 ACCORDING TO THE SHAPE OF THE FUSELAGE AND INSTALL IT IN THE RECESSES ON THE PYLON

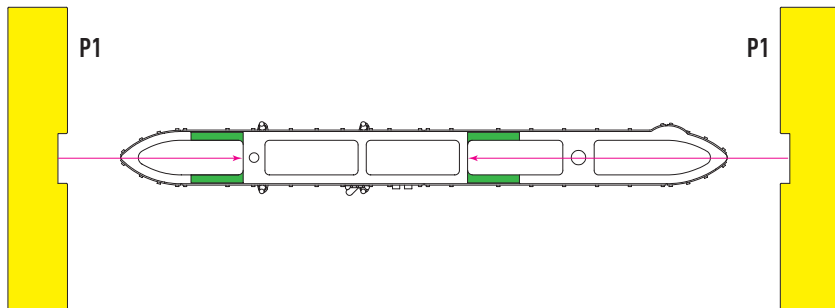

**4 INSTALL PYLON WITH OVERLAYS ON THE FUSELAGE**

