

# A-10A

“COLD WAR HOGS”

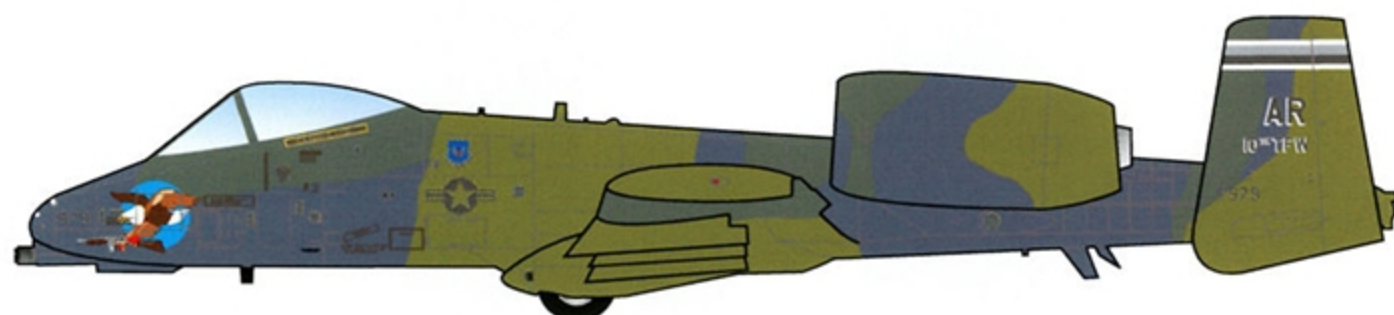
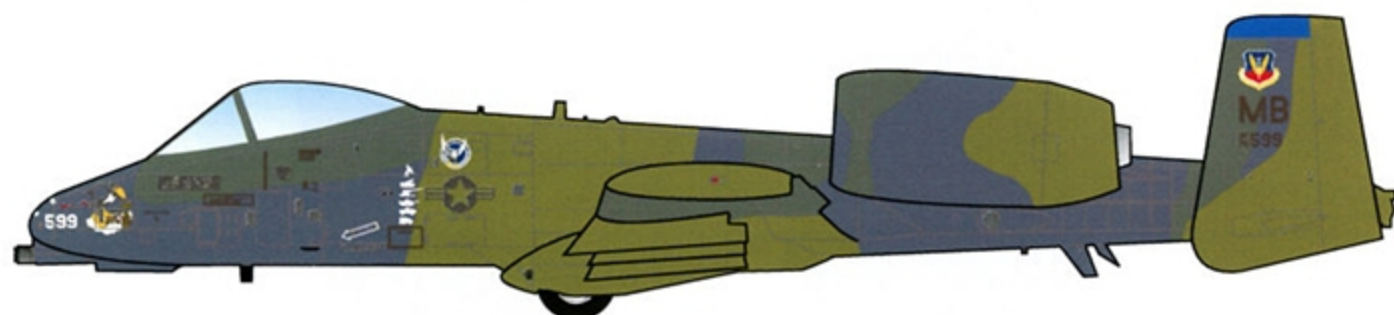
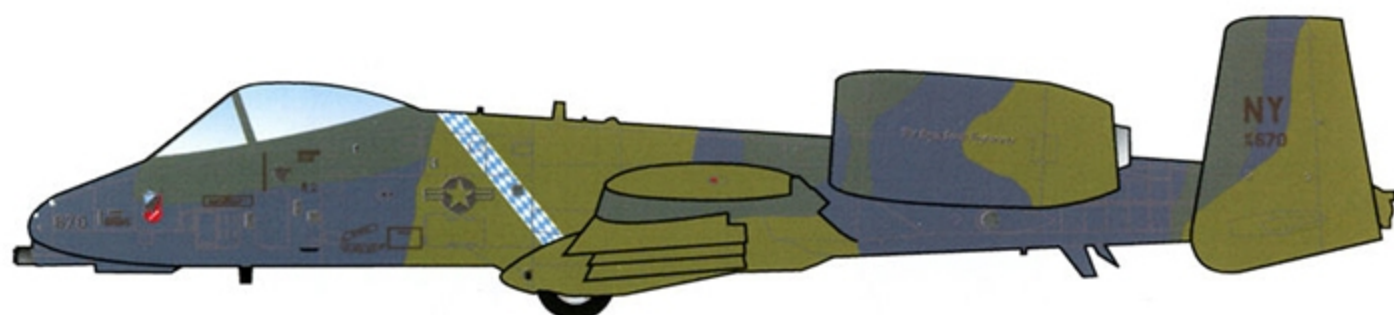

TWELVE MARKING OPTIONS  
FOR EURO-1 CAMOUFLAGED  
A-10A THUNDERBOLTS

**1/48 SCALE**

DECALS PRINTED BY



**OPTION 1: A-10A 78-0670, 138TH TFS, NY ANG**

1984

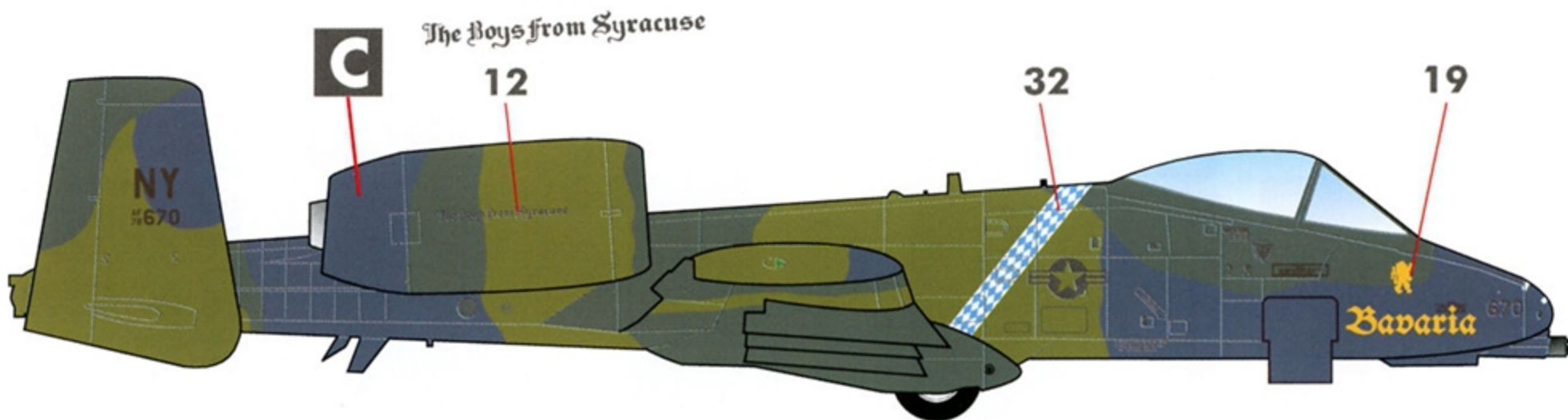
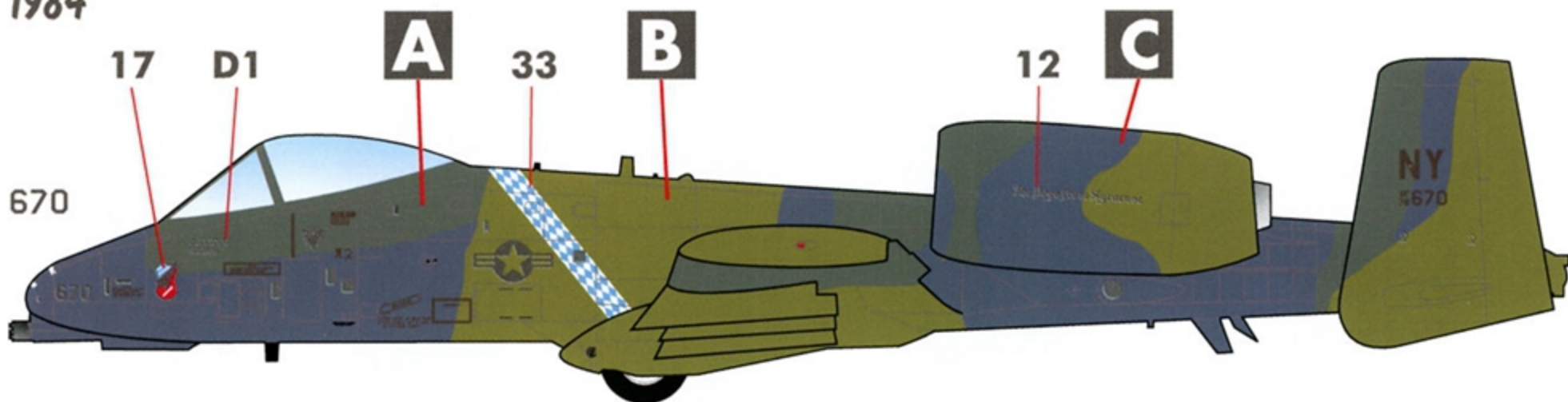

THE A-10A WARTHOGS OF THE NEW YORK ANG WERE DEPLOYED TO LECHFELD AB IN GERMANY SEVERAL TIMES DURING THE 1980S. SOME AIRCRAFT WERE MARKED WITH THE "BAVARIA" NOSE ART ON THE STARBOARD SIDE AND THE BADGE OF THE RESIDENT LUFTWAFFE SQUADRON (JG 32) ON THE PORT SIDE.



**OPTION 2: A-10A 78-0685, 138TH TFS, NY ANG**

1985

AF 78 **685**

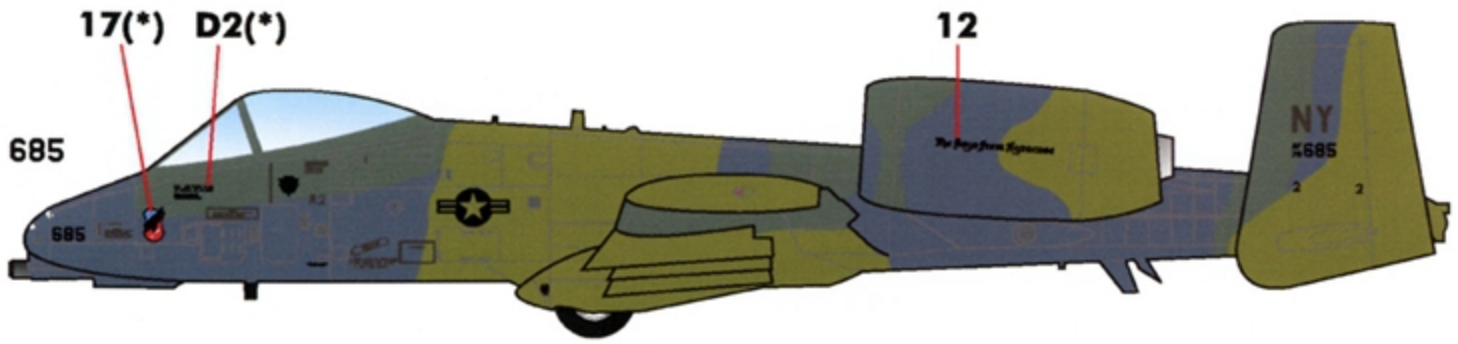

APPLY THE "BAVARIA" NOSE ART ON THE PORT SIDE, AS SEEN ON OPTION 1.

**OPTION 3: A-10A 81-0979, 509TH TFS, RAF ALCONBURY**

1990

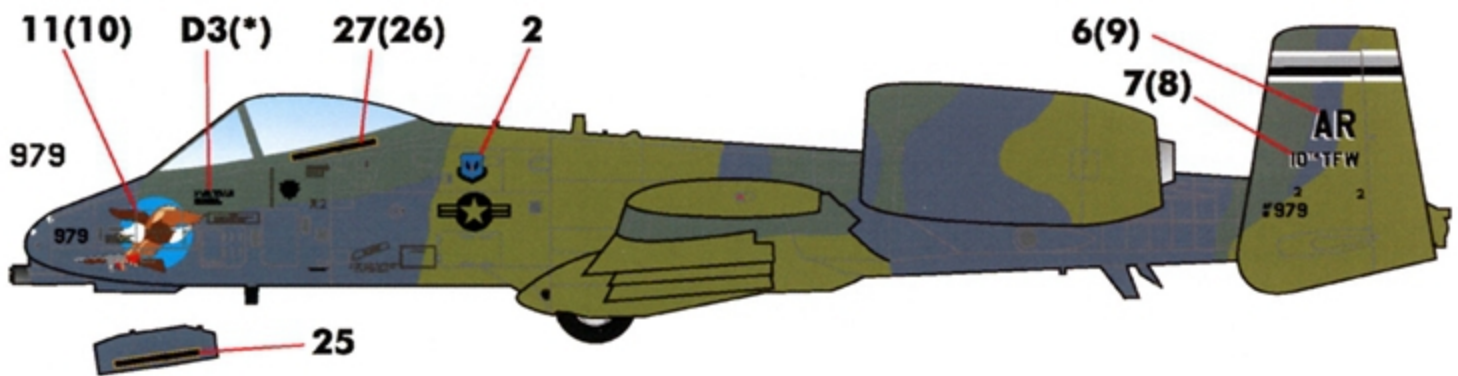

NOSE ART ON BOTH SIDES.

**OPTION 4: A-10A 81-0967 "BROTHERS IN ARMS", 511ST TFS, RAF ALCONBURY,**

1991

AF 81 **967**

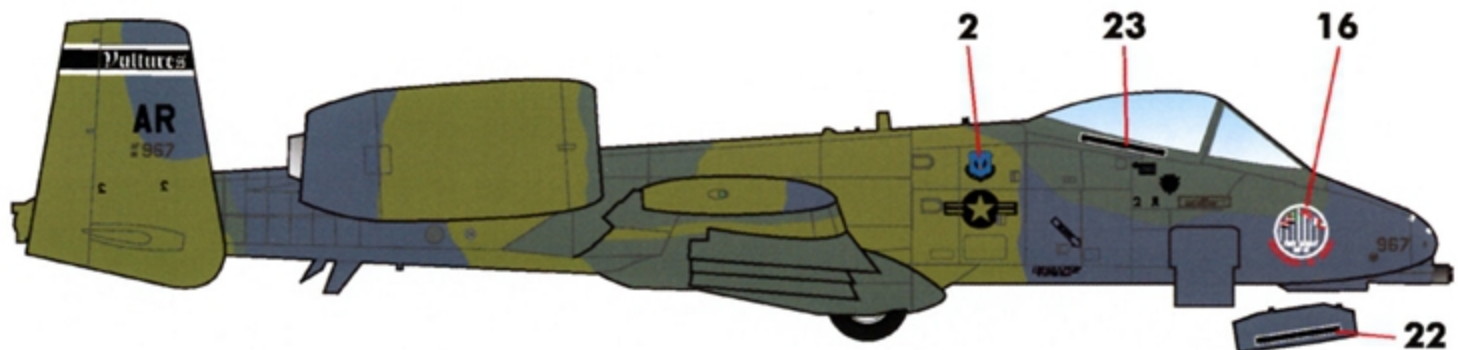
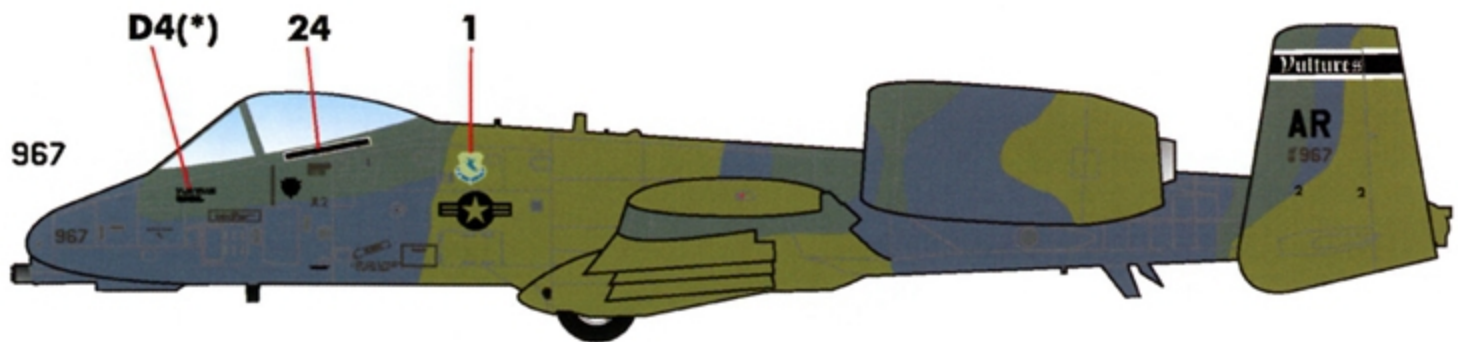

NOSE ART ON STARBOARD SIDE ONLY.



**OPTION 5: A-10A 80-0206, 92ND TFS, RAF BENTWATERS**

1987

AF 80 206

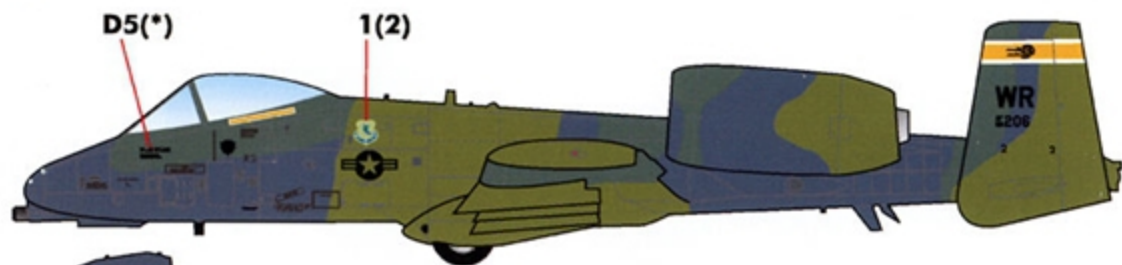

APPLY CREW NAME BLOCKS IN SQUADRON COLORS ON CANOPY SILLS & LANDING GEAR DOOR AS SHOWN.

**OPTION 6: A-10A 81-0952, 510TH TFS, RAF BENTWATERS**

1987

AF 81 952

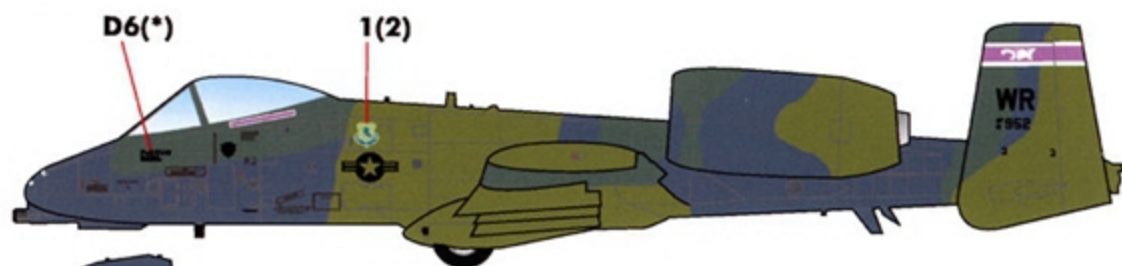

APPLY CREW NAME BLOCKS IN SQUADRON COLORS ON CANOPY SILLS & LANDING GEAR DOOR AS SHOWN.

**OPTION 7: A-10A 81-0962, 91ST TFS, RAF BENTWATERS**

1986

AF 81 962

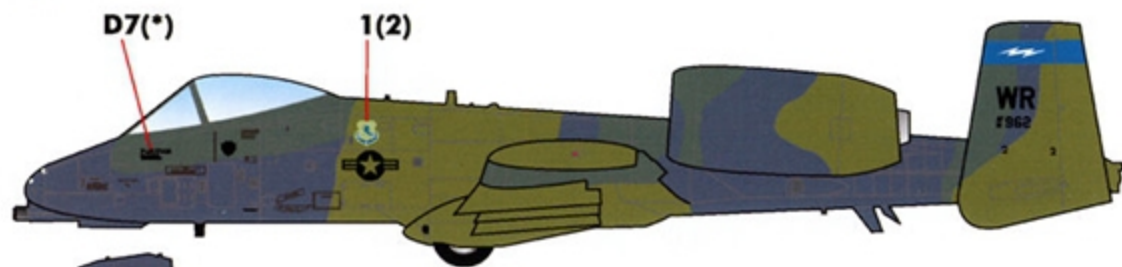

**OPTION 8: A-10A 81-0950, 78TH TFS, RAF BENTWATERS**

1987

AF 81 950

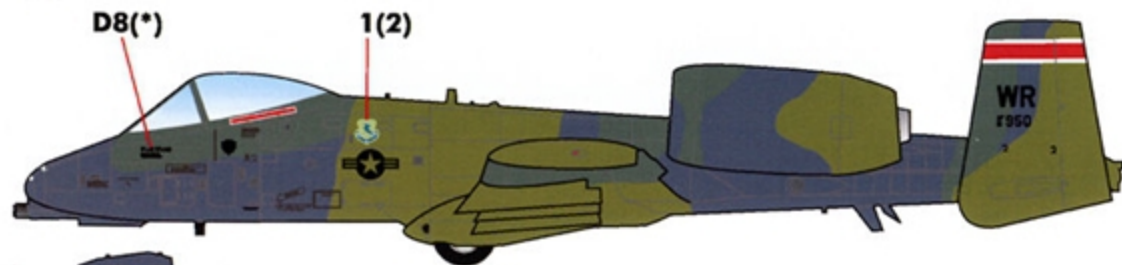

APPLY CREW NAME BLOCKS IN SQUADRON COLORS ON CANOPY SILLS & LANDING GEAR DOOR AS SHOWN.

**OPTION 9: A-10A 78-0599 "BIRD OF PREY", 355TH TFS**

OPERATION DESERT STORM - 1991

AF 78 599

D

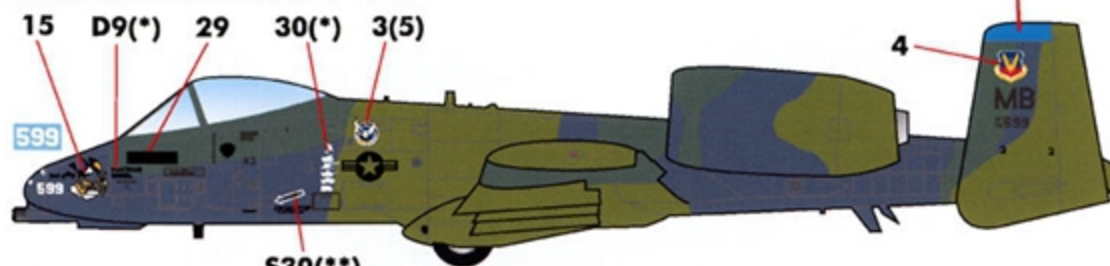

NOSE ART, CREW NAME TAG AND MISSION MARKINGS ON PORT SIDE ONLY.

(\*\*): USE THE WHITE "RESCUE" ARROWS (DECALS S30 AND S33)

**OPTION 10: A-10A 79-0099 "FANG", 355TH TFS**

OPERATION DESERT STORM - 1991

AF 79 099

D

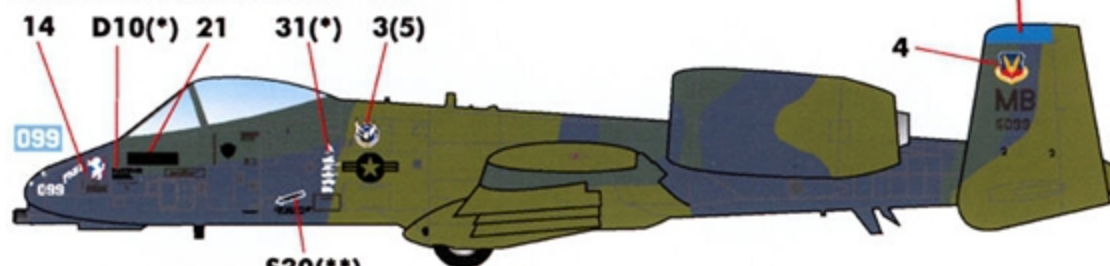

NOSE ART, CREW NAME TAG AND MISSION MARKINGS ON PORT SIDE ONLY.

(\*\*): USE THE WHITE "RESCUE" ARROWS (DECALS S30 AND S33)

**OPTION 11: A-10A 79-0112 "HERE COMES THE JUDGE", 355TH TFS**

OPERATION DESERT STORM - 1991

AF 79 112

D

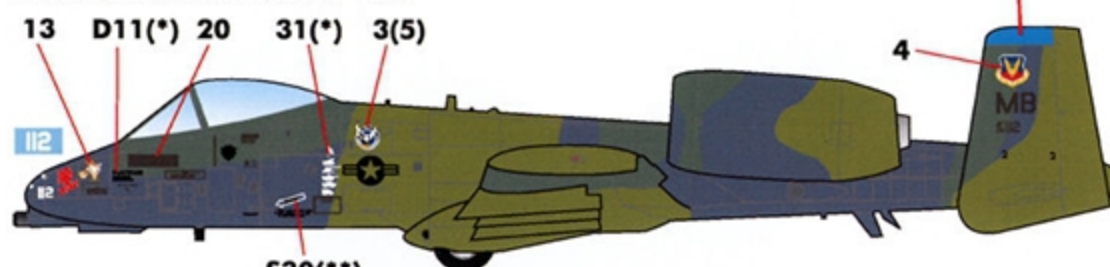

NOSE ART, CREW NAME TAG AND MISSION MARKINGS ON PORT SIDE ONLY.

(\*\*): USE THE WHITE "RESCUE" ARROWS (DECALS S30 AND S33)

**OPTION 12: A-10A 78-0724 "LESLIE THE SEMINOLE WARRIOR", 355TH TFS**

OPERATION DESERT STORM - 1991

AF 78 724

D

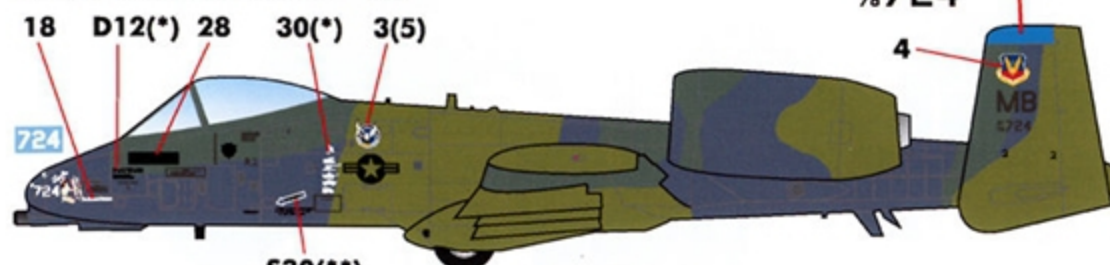

NOSE ART, CREW NAME TAG AND MISSION MARKINGS ON PORT SIDE ONLY.

(\*\*): USE THE WHITE "RESCUE" ARROWS (DECALS S30 AND S33)



**TYPICAL A-10A EUROPEAN ONE CAMOUFLAGE SCHEME**

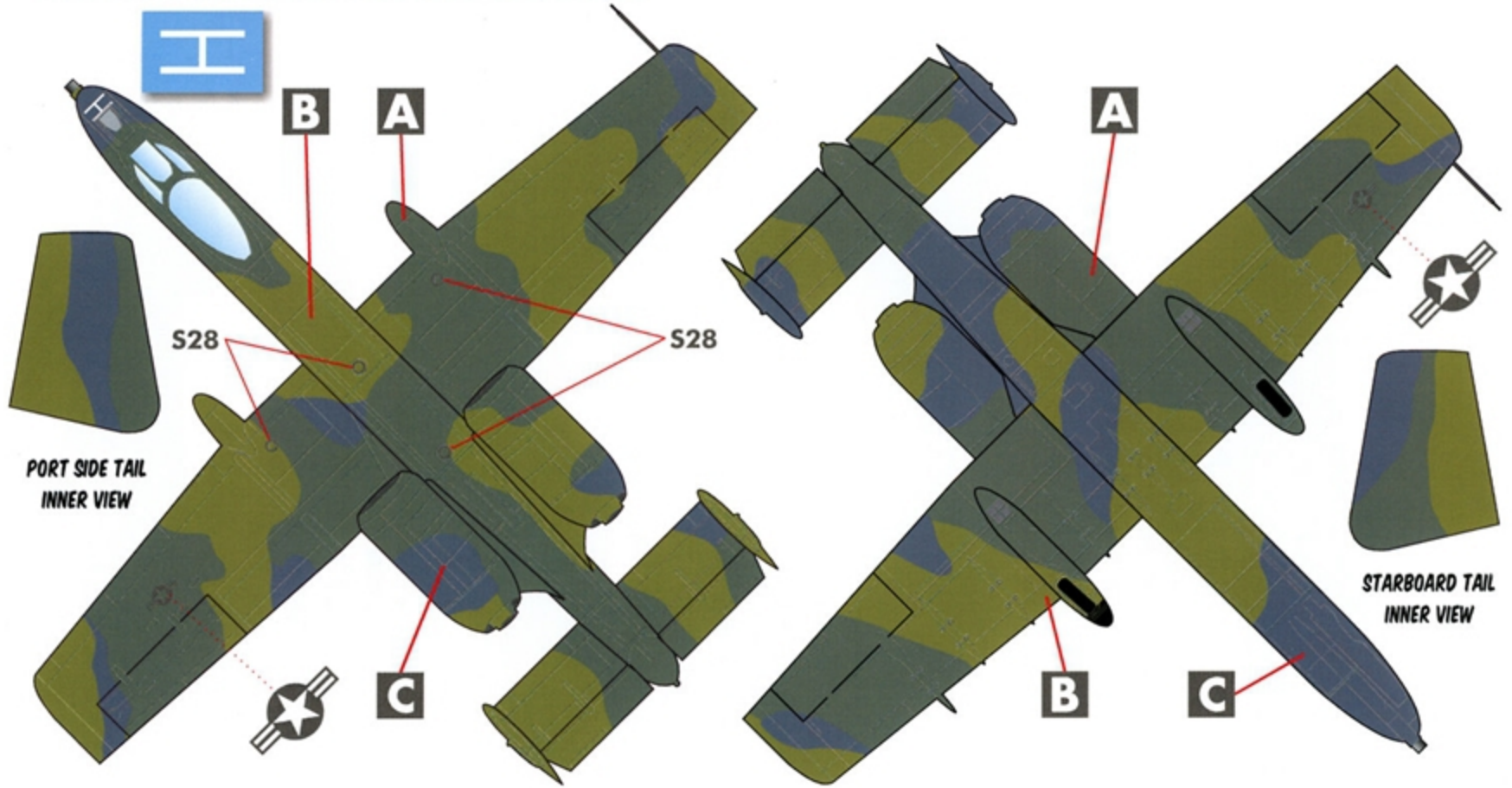

**COMMON STENCILLING FOR A-10A IN "EURO 1" SCHEME IN THE 1980S**

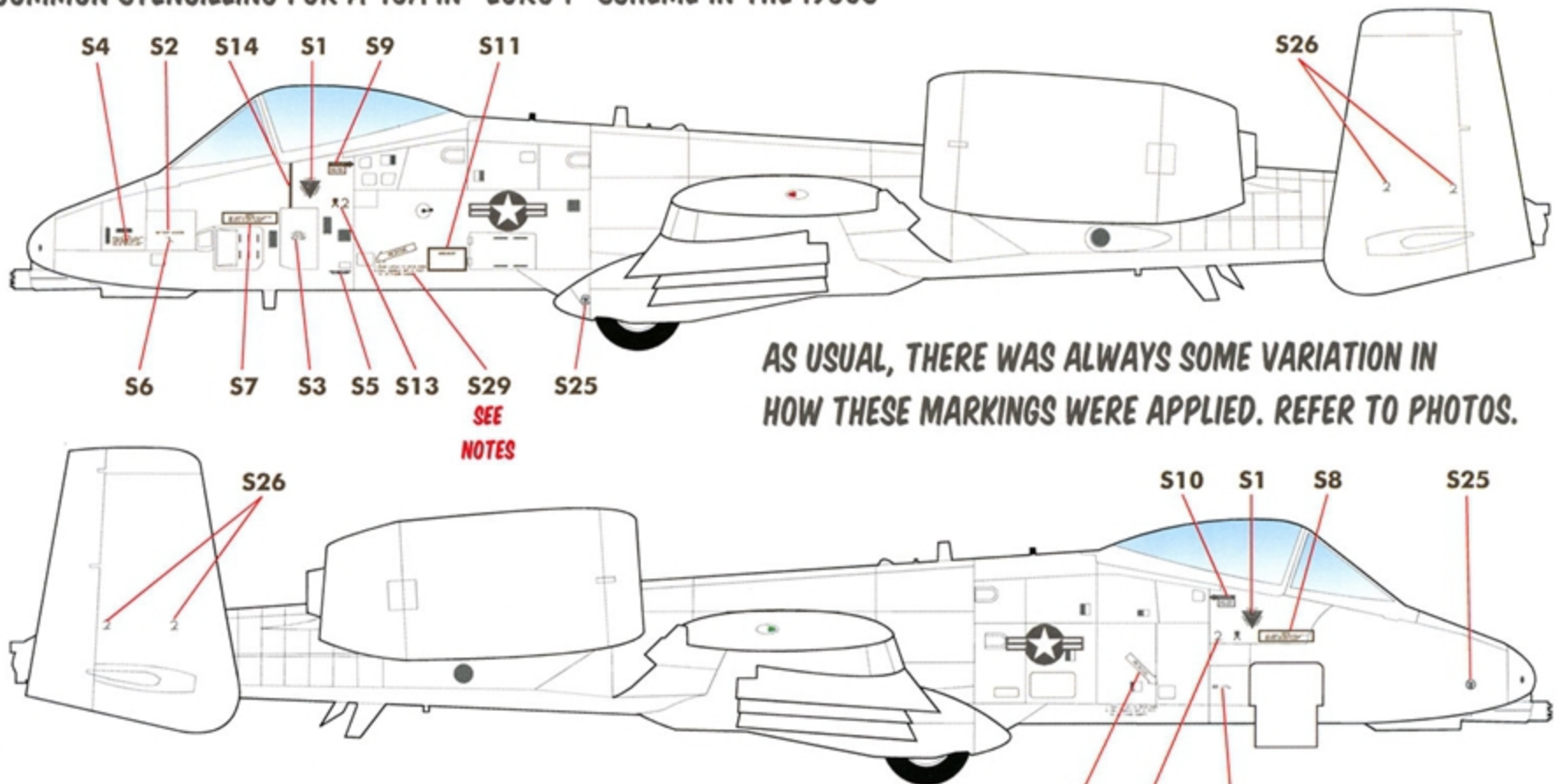

AS USUAL, THERE WAS ALWAYS SOME VARIATION IN HOW THESE MARKINGS WERE APPLIED. REFER TO PHOTOS.

355TH TFS AIRCRAFT USED WHITE "RESCUE" ARROWS - USE DECALS S30/S33 INSTEAD OF S29/S32 FOR OPTIONS 9-12.

SEE NOTES

LAST THREE DIGITS OF SERIAL  
ON OPTIONS 5-8 IN FRONT OF NOSE  
(80-0206 SHOWN)



## LOCATION OF DATA BLOCKS

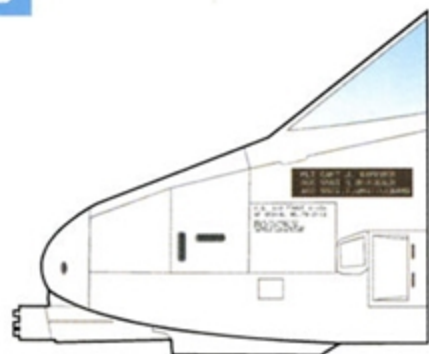

355 TFS JETS  
(OPTS 9-12)

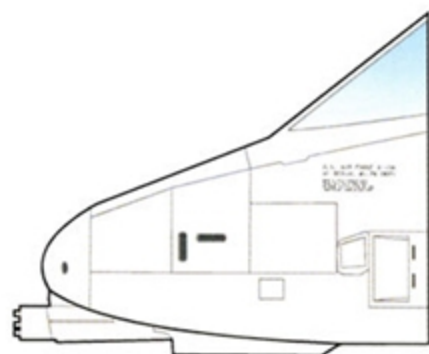

ALL OTHER  
OPTIONS

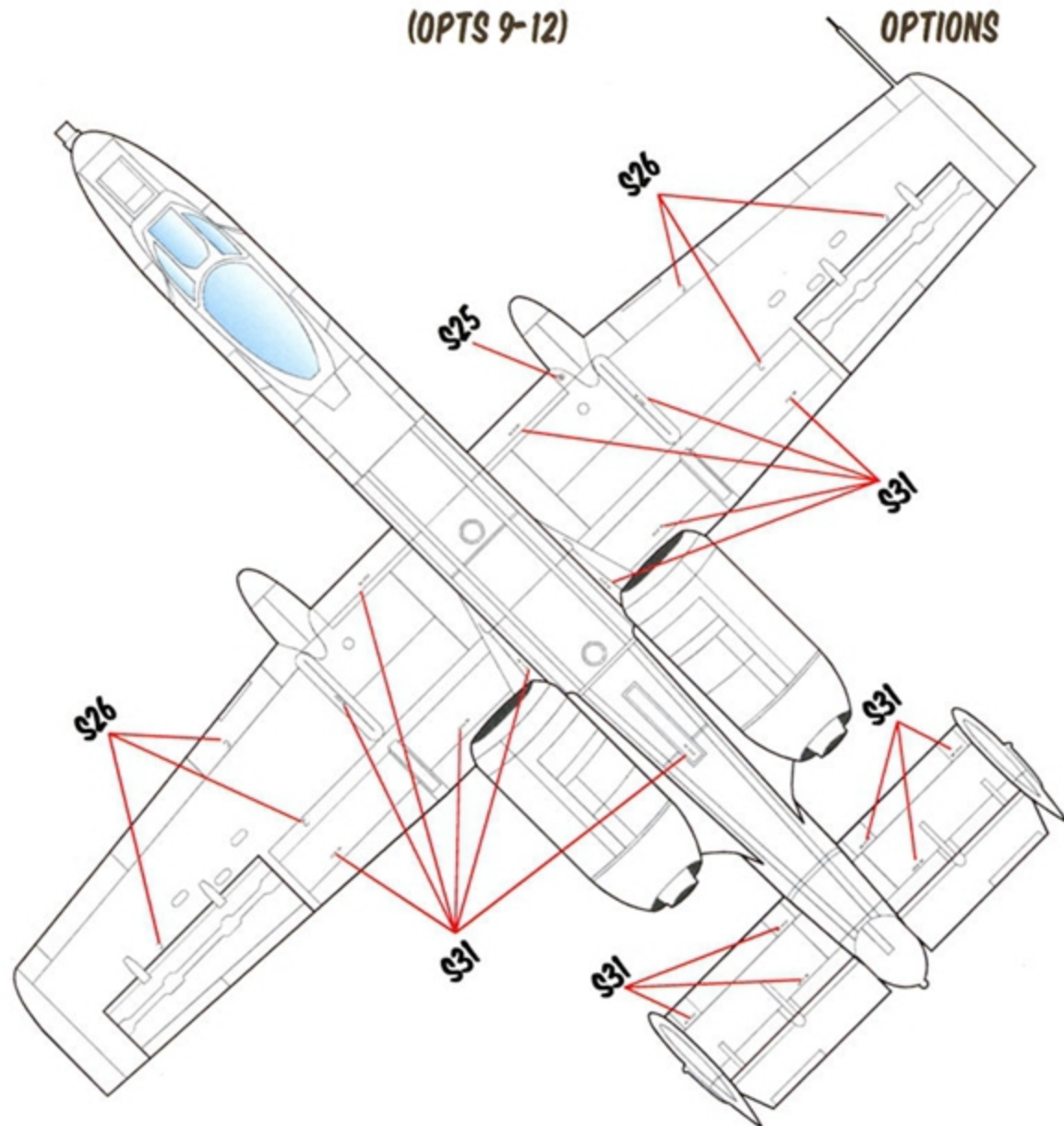

- A** EURO ONE DARK GREEN (FS34092)
- B** MEDIUM GREEN (FS34102)
- C** EURO ONE GRAY (FS36081)
- D** BLUE (FS35095)

CARACAL MODELS WOULD LIKE TO THANK  
**BILL MITTAG**

FOR HIS INVALUABLE HELP IN THE DESIGN OF THIS DECAL SHEET.

Caracal Models  
PO Box 92141  
Austin, TX 78709  
info@caracalmodels.com  
http://www.caracalmodels.com