

48-110

1/48 SCALE

CAM



Battlin'
WILDCATS

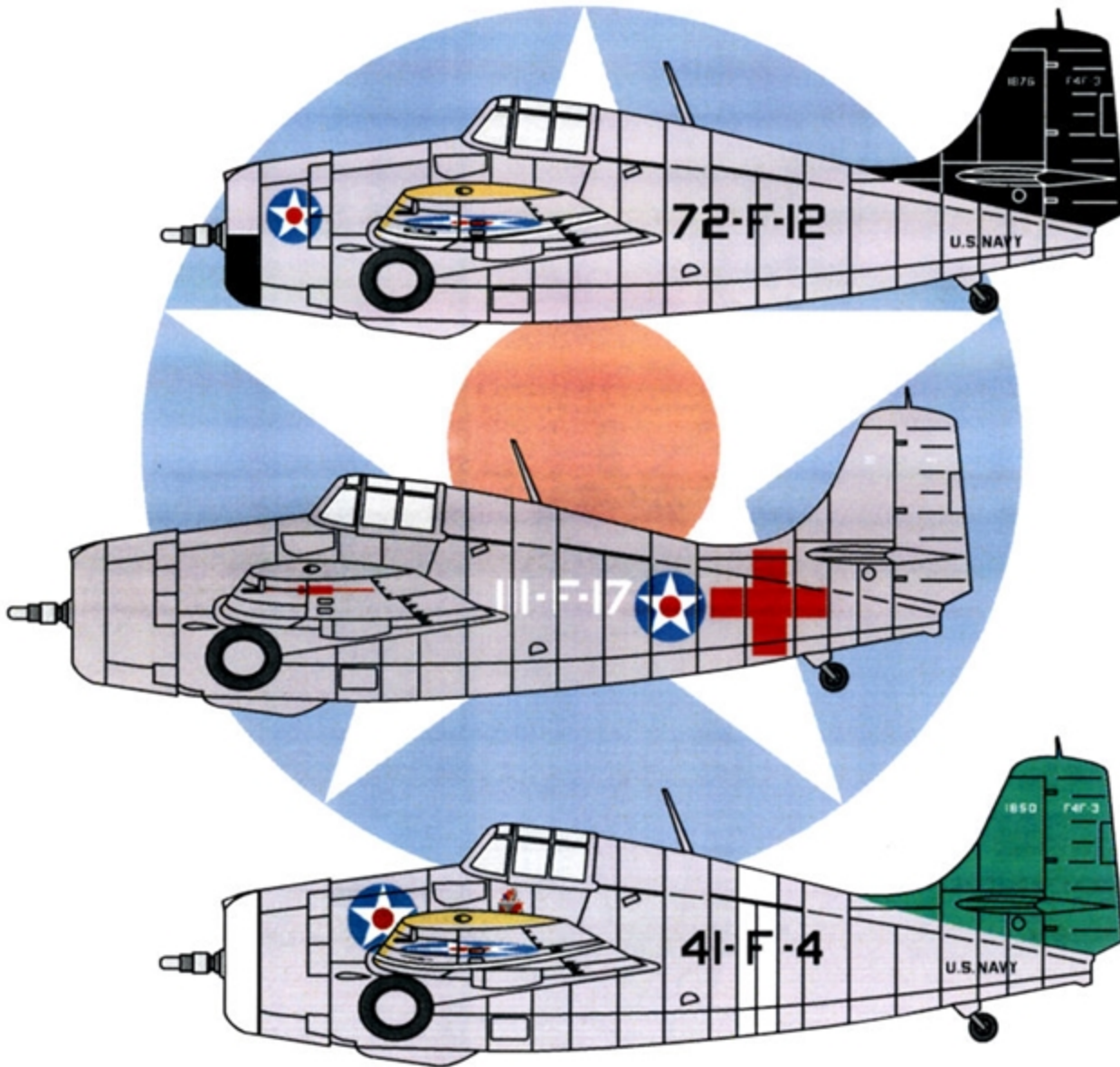

CUSTOM AERONAUTICAL MINIATURES

GRUMMAN F4F-3A WILDCAT
VF-72 / VMF-111 / VF-41

WWW.CAMDECALS.COM

48-110

Battlin' WILDCATS

Grumman F4F-3A Wildcat
 BuNo 01876
 VF-72
 USS *Wasp* (CV-7)
 1941

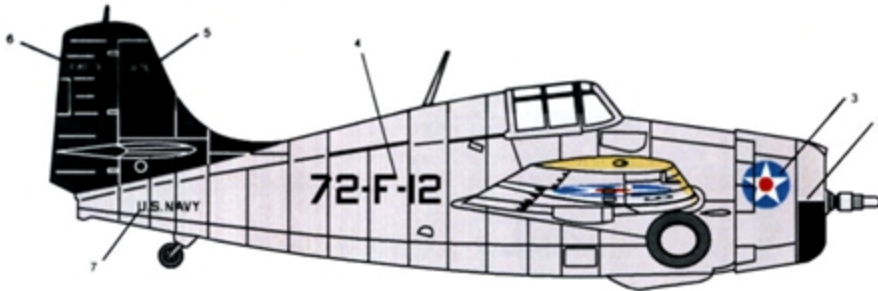

COLOR GUIDE

- BARE METAL (ALUMINUM)**
Fuselage / lower wings
- GLOSS BLACK**
Vertical tail / horizontal stabilizer
- ORANGE-YELLOW (FS 13538)**
Upper wings

Grumman F4F-3 Wildcat
 BuNo 03923
 VMF-111
 1941 Wargames

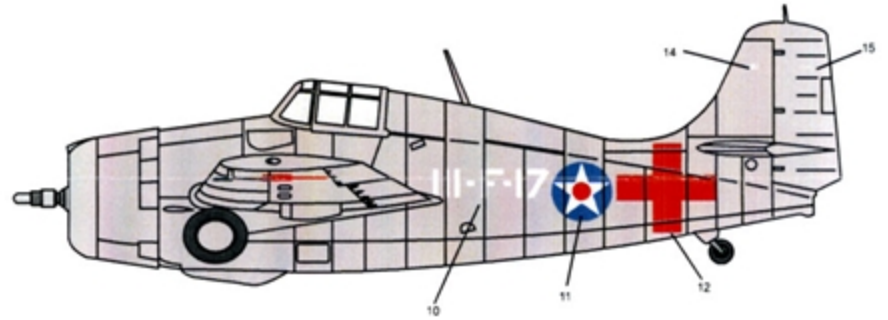
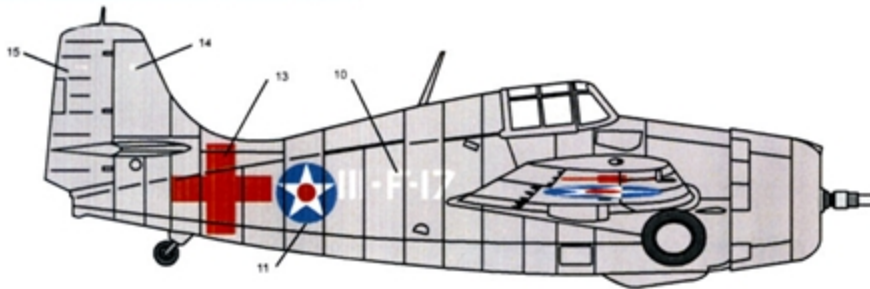

COLOR GUIDE

- LIGHT GULL GRAY (FS 36440)**
Overall color

Grumman F4F-3A Wildcat
 BuNo 01850
 VF-41 *Red Rippers*
 USS *Ranger* (CV-4)
 1941

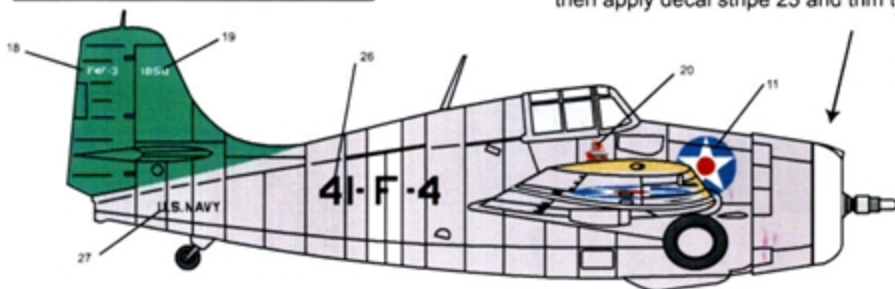

Paint forward cowl Gloss White,
 then apply decal stripe 25 and trim to fit.

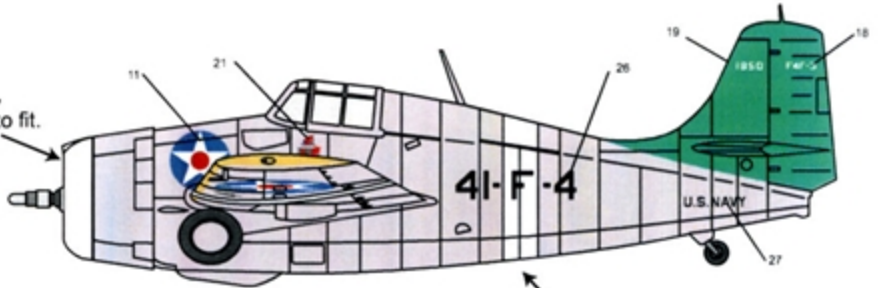

Paint fuselage stripe Gloss White
 (5/16" / 8mm),
 then apply decal stripes and trim to fit.

COLOR GUIDE

- BARE METAL (ALUMINUM)**
Fuselage / lower wings
- GLOSS WHITE**
Cowl / fuselage stripe
- ORANGE-YELLOW (FS 13538)**
Upper wings
- WILLOW GREEN (FS 14187)**
Vertical tail / horizontal stabilizer

VF-72

Upper Wing

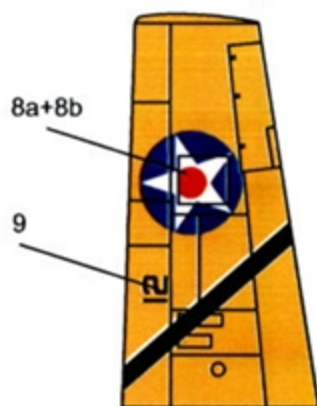

Lower Wing

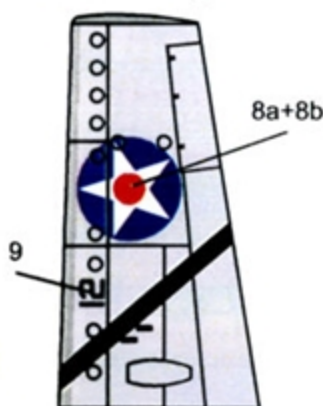

Paint wing stripes Gloss Black (7/32" / 5.5mm), then apply decal stripes and trim to fit.

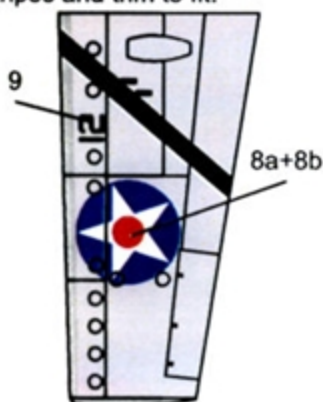
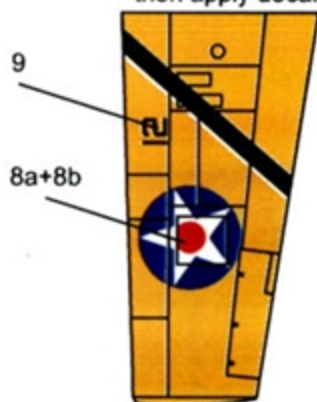

VMF-111

Upper Wing

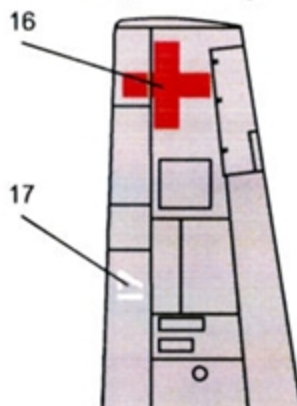

Lower Wing

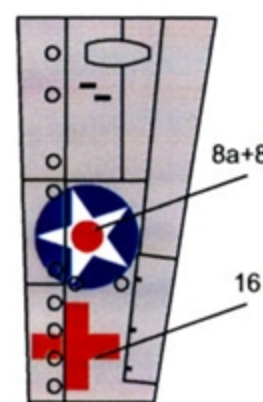
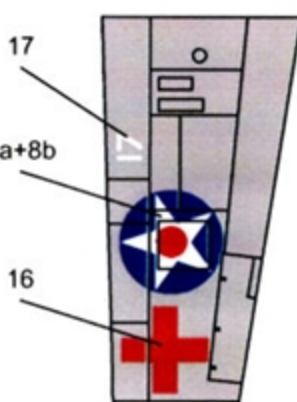
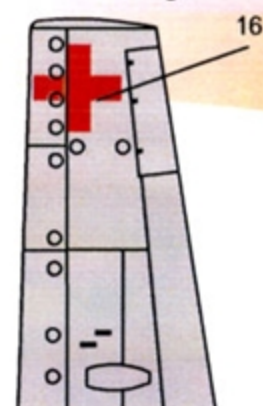

VF-41

Upper Wing

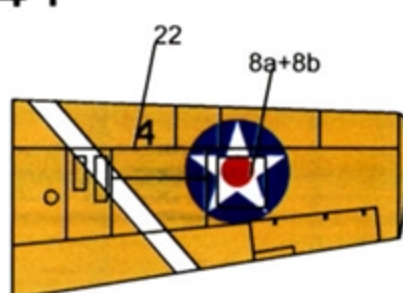
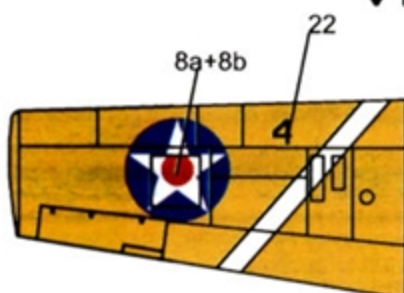

Paint wing stripes Gloss White (7/32" / 5.5mm), then apply decal stripes and trim to fit.

Lower Wing

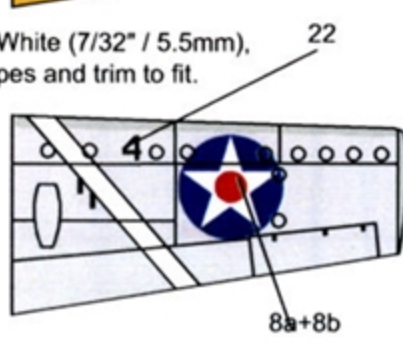
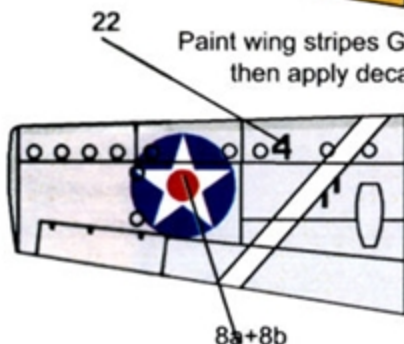

COLOR GUIDE



BARE METAL (ALUMINUM)



LIGHT GULL GRAY (FS 36440)
Overall color



ORANGE-YELLOW (FS 13538)

RECOMMENDED KIT:

Tamiya 1/48 F4F-4 (with Just Plane Stuff / KMC
scratchbuilt conversion to F4F-3)

REFERENCES:

Osprey *Wildcat Aces #3*
Squadron/Signal *F4F Wildcat in action*

CUSTOM AERONAUTICAL MINIATURES

10 Potomac Irvine, CA 92620

ALL RIGHTS RESERVED

Copyright ©2004

To order our full color catalog, visit us on the web at
www.camdecals.com