

Mil Mi-24 "Hind" Air-Condition Compartment & Ammo Box Set

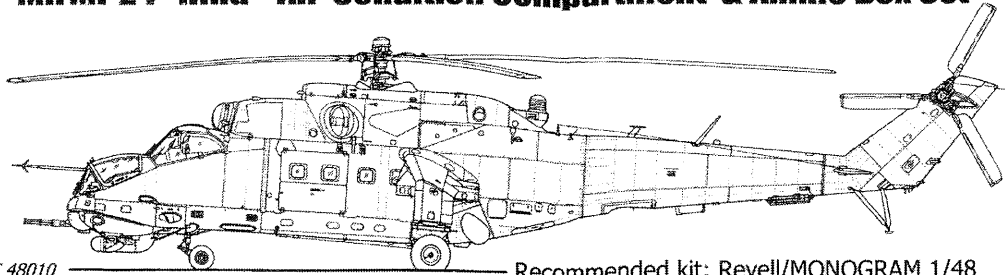

TC 48010

Recommended kit: Revell/MONOGRAM 1/48



Detailed resin set to make the Mil Mi-24 D/V/VP/VM variants.

For experienced modellers.

Many items have a complex shape and a very slim design and require increased care and accuracy in circulation.

For best result gluing use cyanoacrylate glue.

Not for children.

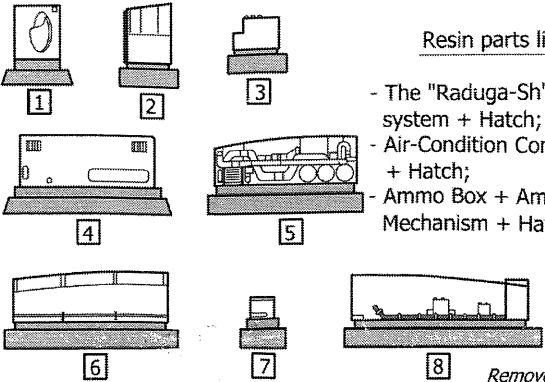

Resin parts list:

- The "Raduga-Sh" navigation system + Hatch;
- Air-Condition Compartment + Hatch;
- Ammo Box + Ammo Feed Mechanism + Hatch;

Remove shaded areas

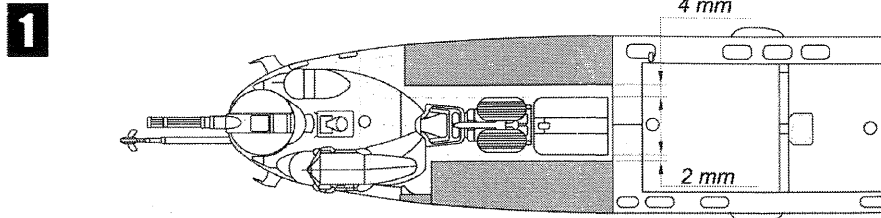

Cut out shaded areas

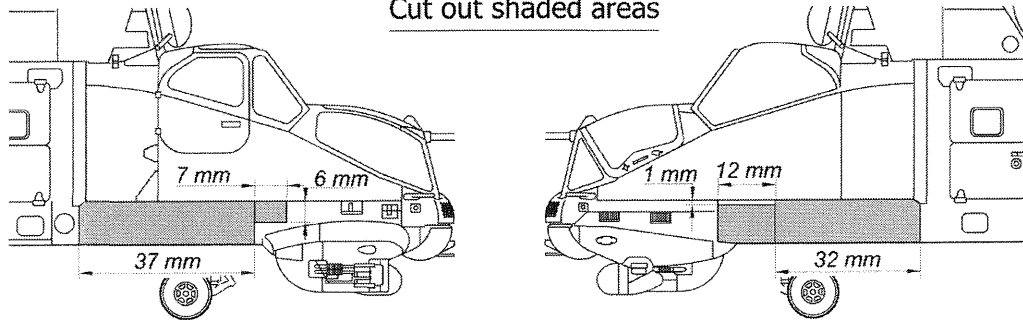

Recommended reference materials:

- WWW #4 Hind in details;
- Lock On 16 Mi-24W Hind E;
- 4+ Mi-24 D,V,DU;
- Kagero Topshots 03 Mi-24 D/W.

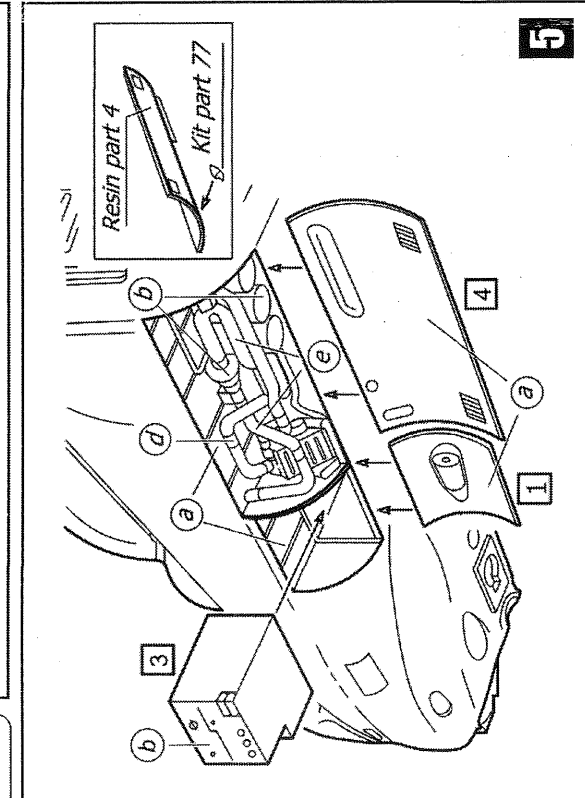
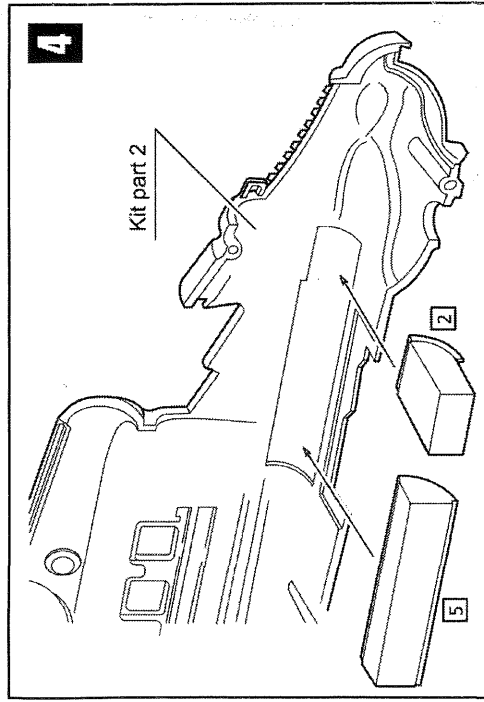
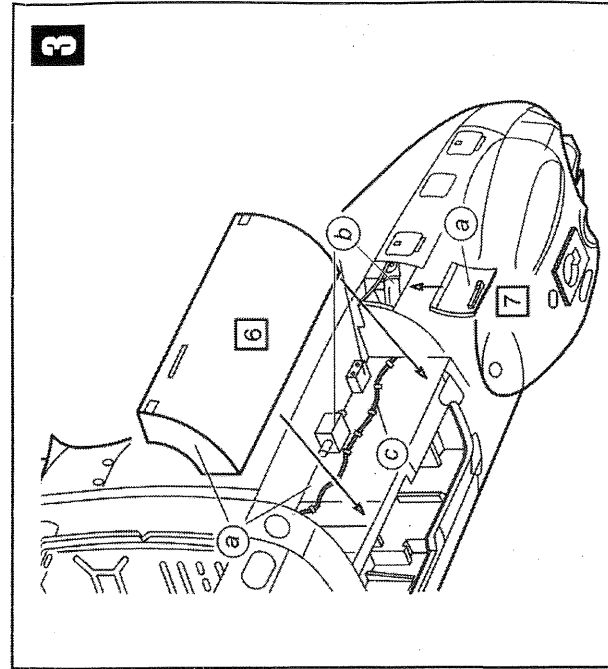
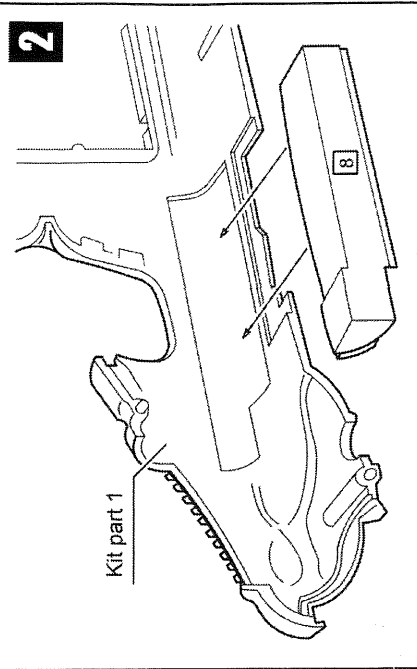

COLORS

- (a) Blue-Grey
- (b) Aluminium
- (c) Black
- (d) White
- (e) Green