



HAUNTED MANOR

MODEL KIT SERIES

Escape from the Dungeon



KEY

- 1** Step number
- 1** Assembly order
- 37** Part number
- ← - -** Cement
- ←** Do Not Cement

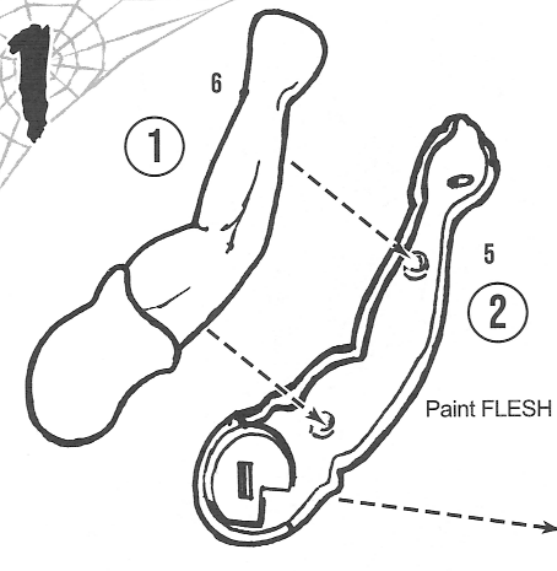

Make sure glue dries before going on to the next step

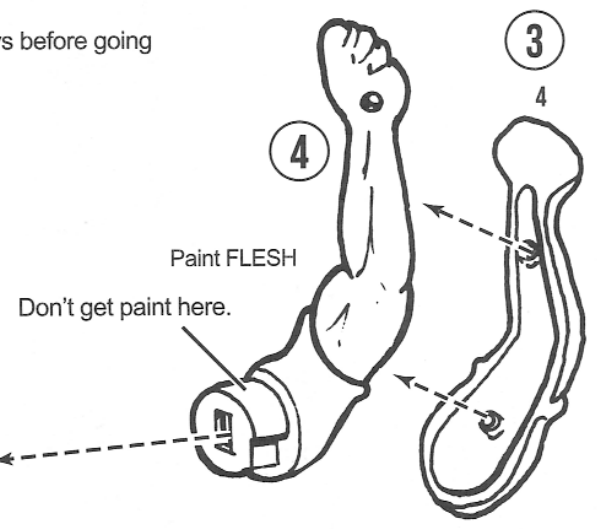

2

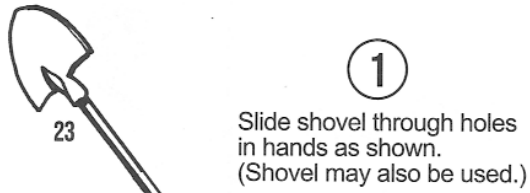

Do not cement until last assembly.

3

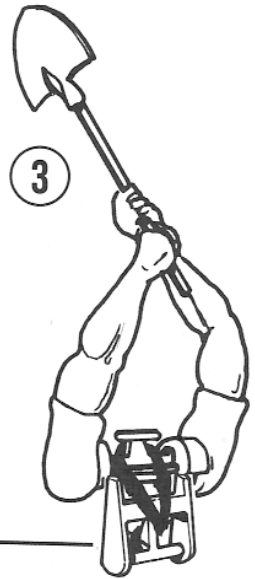

Paint BROWN

2

Slide rubber band through part 32 as shown

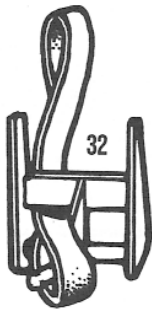

The smaller rubber band.

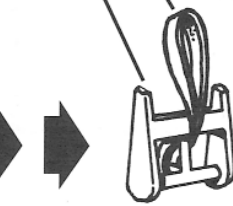
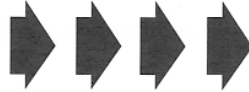

Hook over retainer.

Do not cement.

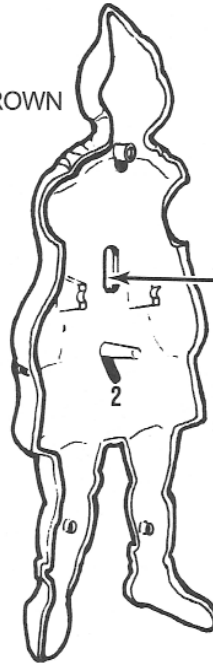

Locate to back body half, DO NOT CEMENT.

3



With the tool provided, hook rubber band under pin as shown,

2

Cement front body half to rear body half.

Do not cement here.

Rubber band hook.

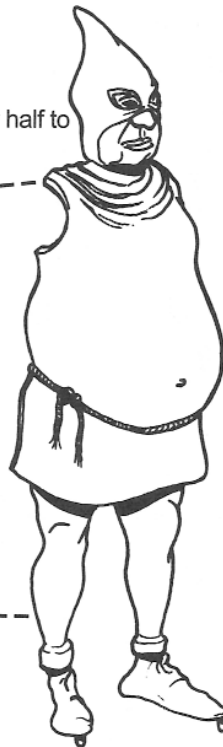

Paint BROWN

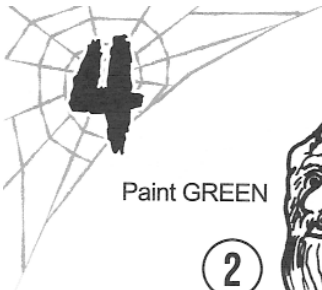

4

Paint GREEN

2



9

Paint LIGHT BROWN

3

11



Paint BLUE

1

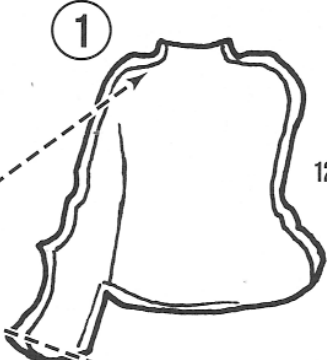

12

5



4

40

Paint BLUE

Paint GREEN

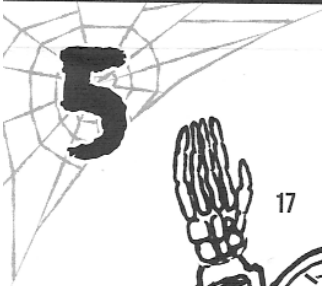

5



17

6

Paint Purple



19

1

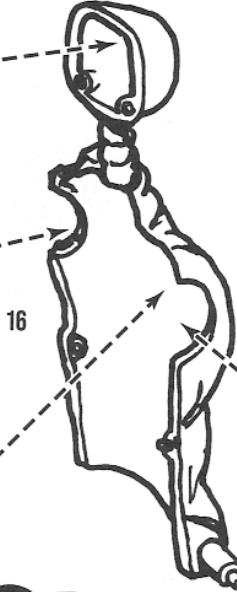

16

Paint Purple

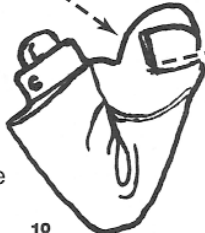

18

7

Paint WHITE



15

3

Paint Purple

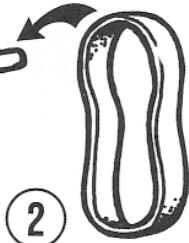

2

Loop rubber band over pin as shown. Do not cement



17

5

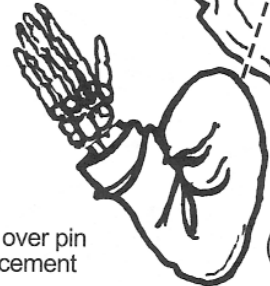

18

4

6

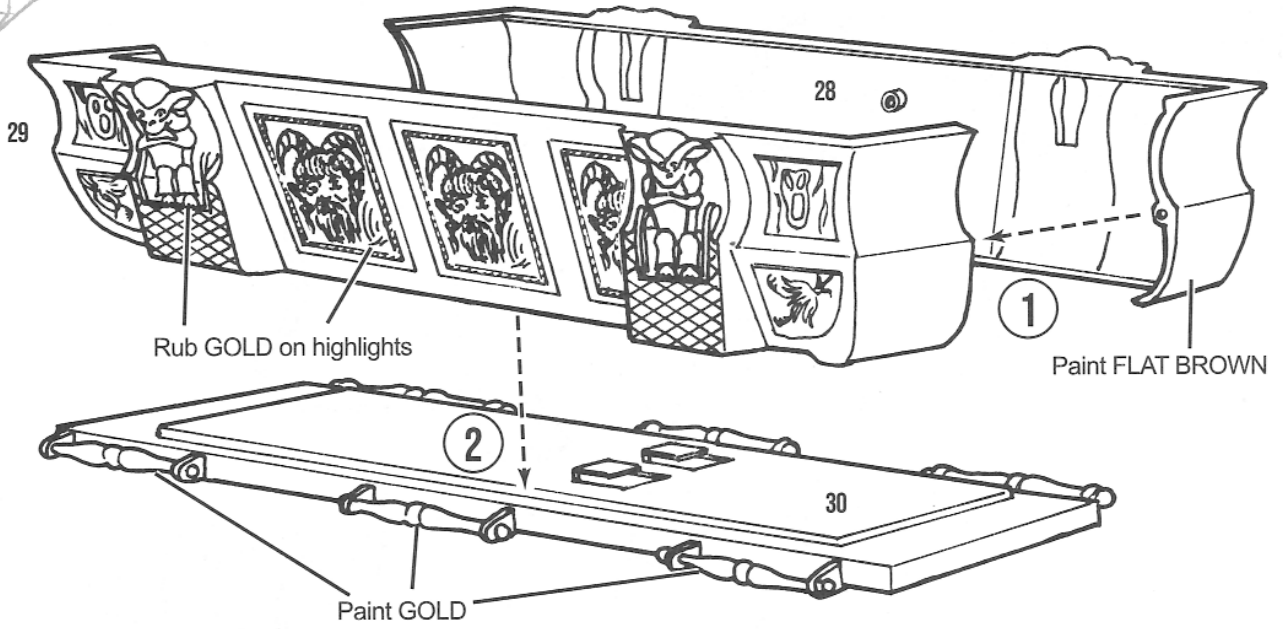

7



Place assembled skeleton into position, **DO NOT CEMENT** making sure the rubber band fits under tabs.

1

Spread apart carefully and do not cement.

Place retainer into position, **DO NOT CEMENT** (See details for correct position)

2

31

Move rubber band back if it doesn't work correctly.

Rubber band should be pulled down in front of the cross brace on the skeleton.

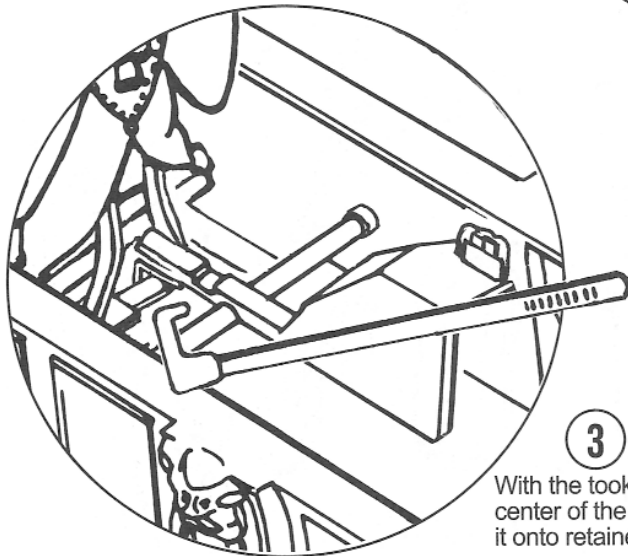

With the tool provided, hook the center of the rubber band and slide it onto retainer and into notch (See arrow).

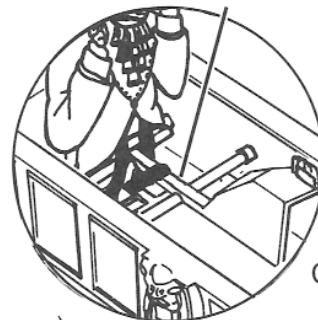

COMPLETED ASSEMBLY

8

Make sure feet are in the right locations according to the chain.

Paint FLESH 14 Paint BLUE

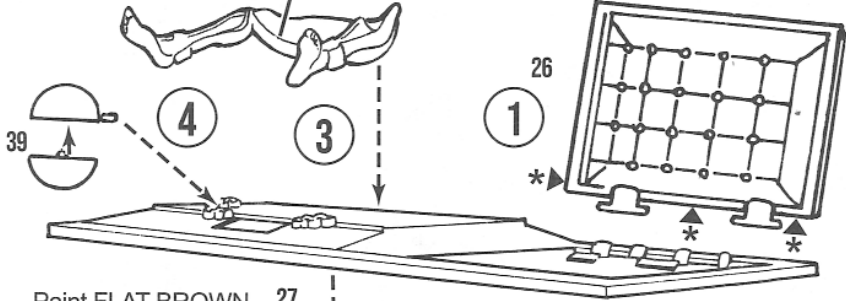

Paint FLAT BROWN 27

2 Paint inside RED

Make sure you do not cement or get paint on the workable hinges.

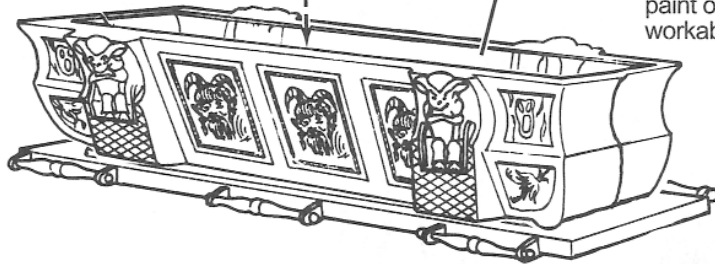

9

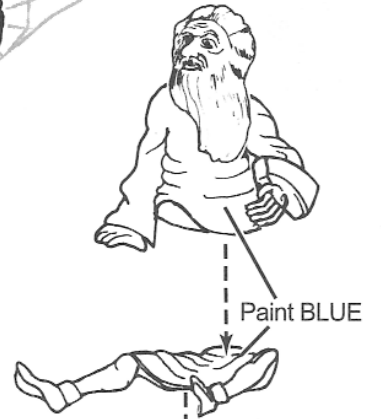

Paint FLESH

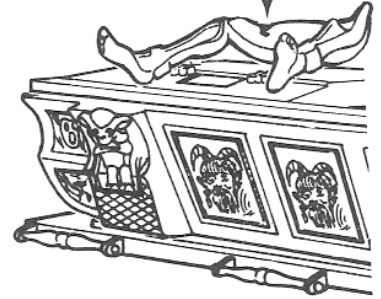

10

NOTE: When positioning the executioner, lower his arms and be sure the shovel hits the chain at the right angle to allow the casket door to "pop" open.

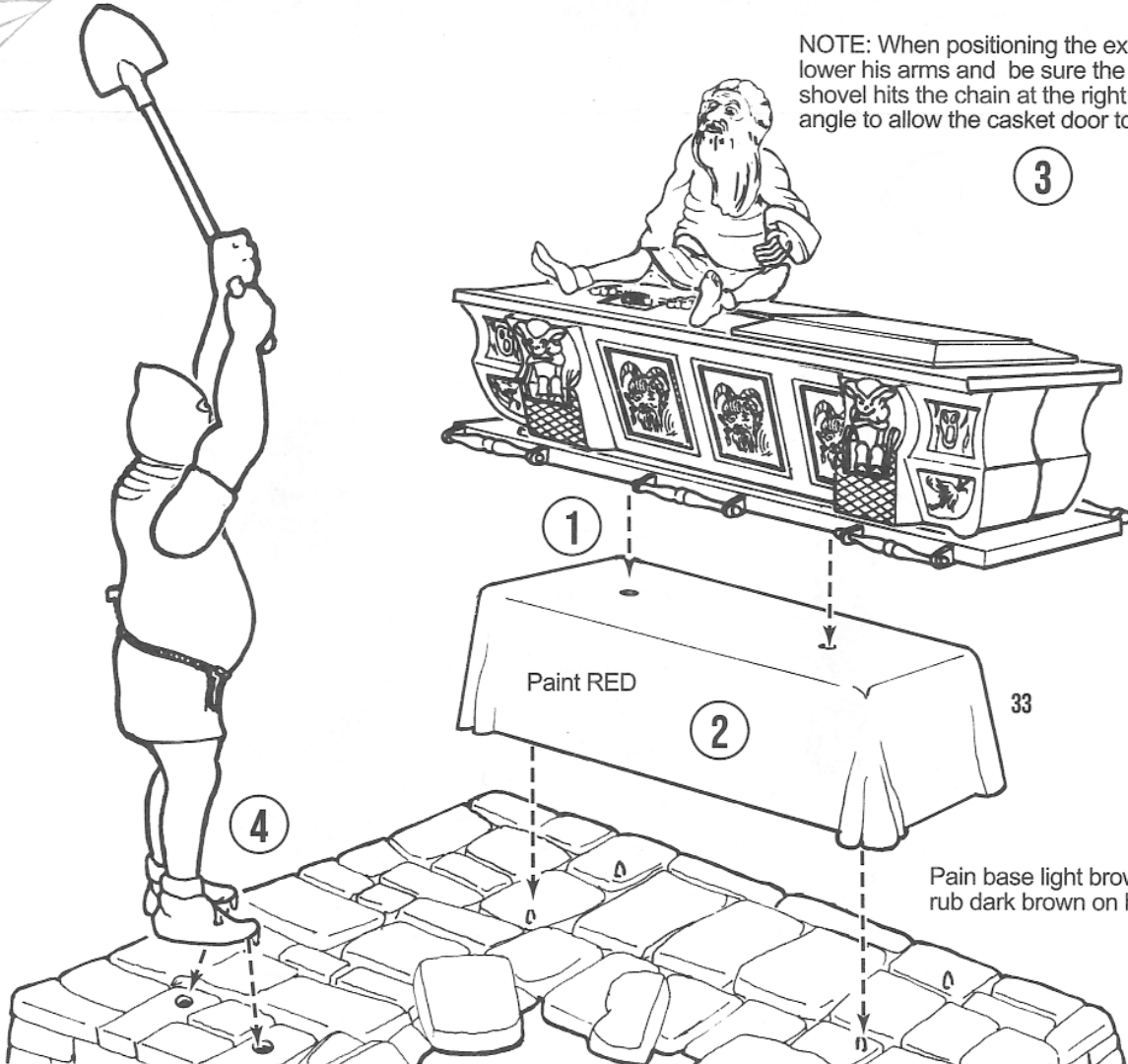

3

Paint RED

2

33

Paint base light brown and then rub dark brown on highlights

