

DETAILS AFTER REMOVAL FROM SPRUES

 USE A SAW TO REMOVE SUPPORTS
FROM 3D PRINTED PARTS



R4 X2



R7 X2



R8 X2

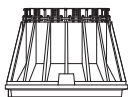

R9 X2

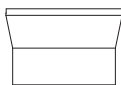

R3 X2



R5 X2



R6 X2

1 X2

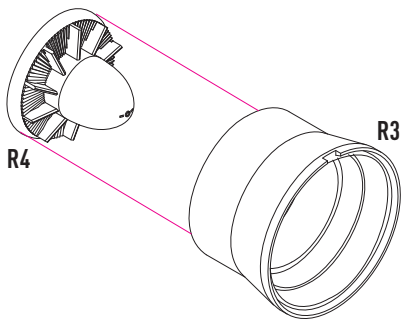

2 X2

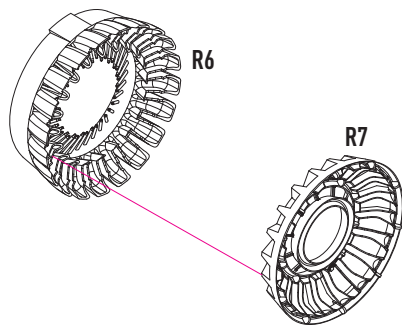

3 X2

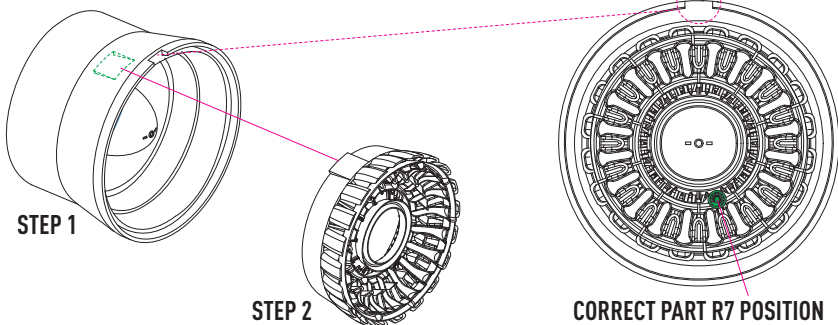

4 X2

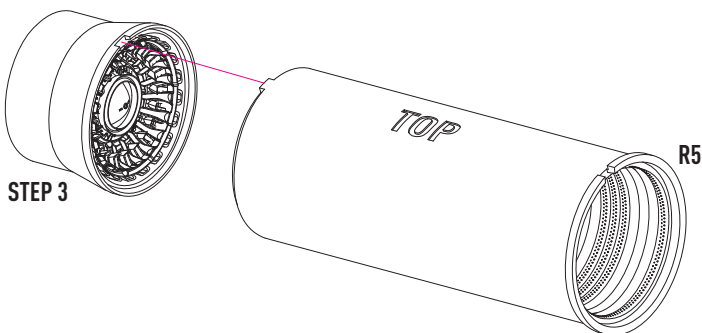

5 X2

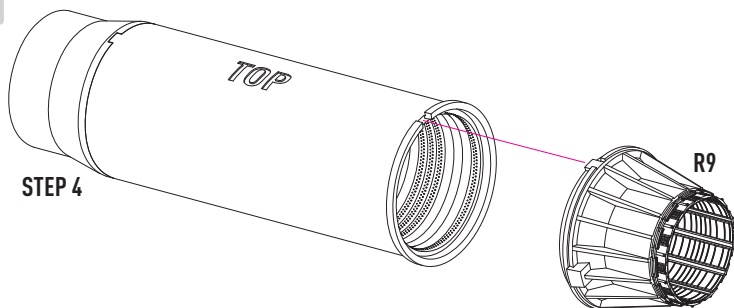

6 X2

