









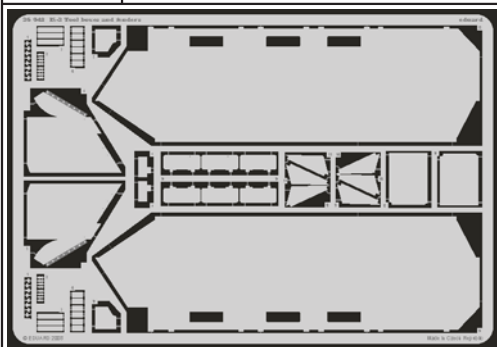

IS-3 Tool boxes and fenders

eduard

36 042

1/35 scale detail set for TAMIYA kit • sada detailů pro model 1/35 TAMIYA



-  APPLY EXPRESS MASK AND PAINT BEFORE GLUING
POUŽIT EXPRESS MASK NABARVIT PŘED SLEPENÍM
-  SYMMETRICAL ASSEMBLY
SYMETRICKÁ MONTÁŽ
-  REMOVE
ODSTRANIT
-  GRIND
OBROUSIT
-  DRILL HOLE
VRTAT OTVOR
-  BEND
OHNOUT
-  OPTION
VOLBA
-  REPLACE
NAHRADIT

-  ORIGINAL KIT PARTS
PŮVODNÍ DÍLY STAVEBNICE
-  PHOTO-ETCHED PARTS
LEPTANÉ DÍLY
-  PARTS TO BE REMOVED
DÍLY K ODSTRANĚNÍ
-  FILL
TMELIT

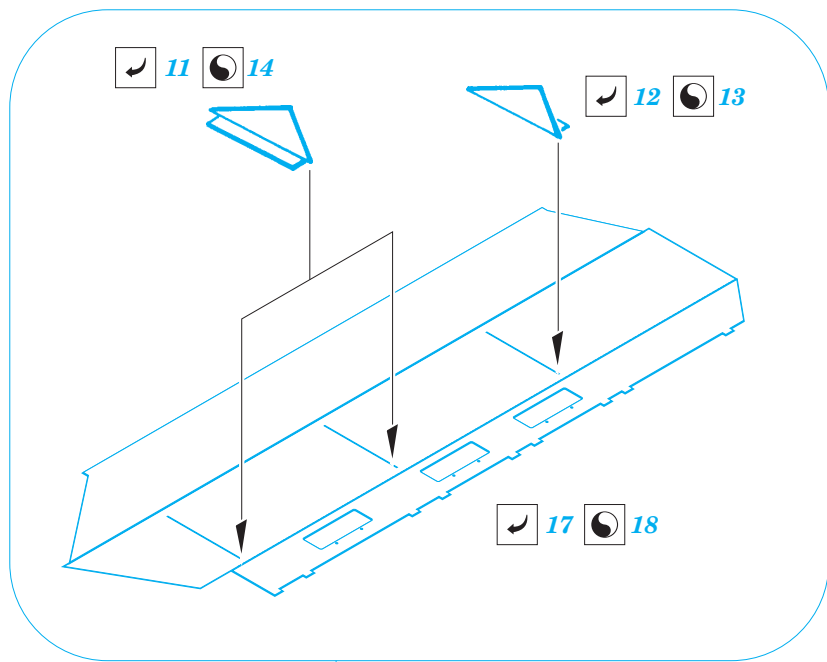
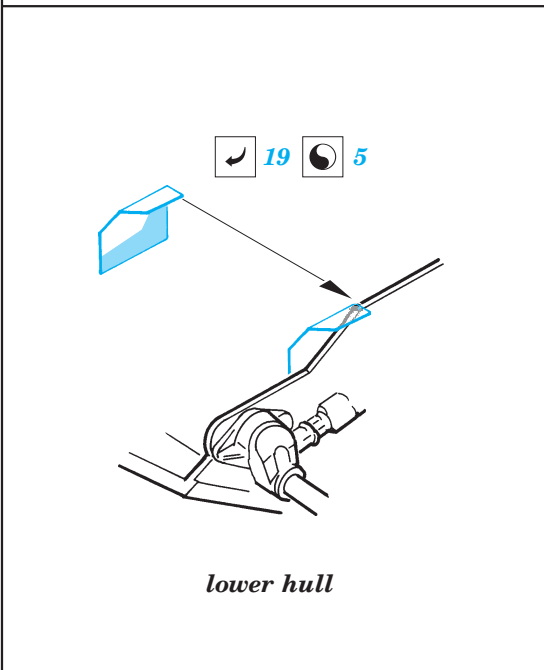

REFERENCES:

Model Detail Monograph No.7 - IS-3
 WWP Spec. Museum Line No.24 - Army Tech. Museum at Lešany
 Panzer No.282 10/1996
www.jagdtiger.de

