

Zestaw Kalkomanii Decals

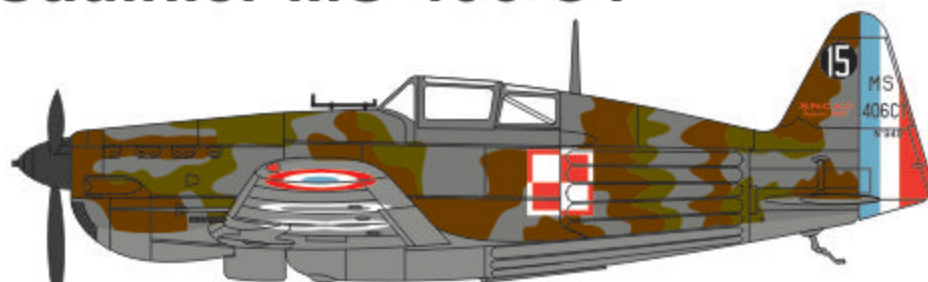

Morane Saulnier MS 406 C1

No.949 (L-980) "15", GC I/2 Xaffevillers,
por. Józef Brzeziński, April 1940.



No.991 (L-720), GC I/2 Coulommiers,
ppor. Stanisław Chałupa, 8 of June 1940.



Canopy mask.

No.947 "XVIII", GC I/2, Dambin,
plut. Antoni Beda, April 1940.

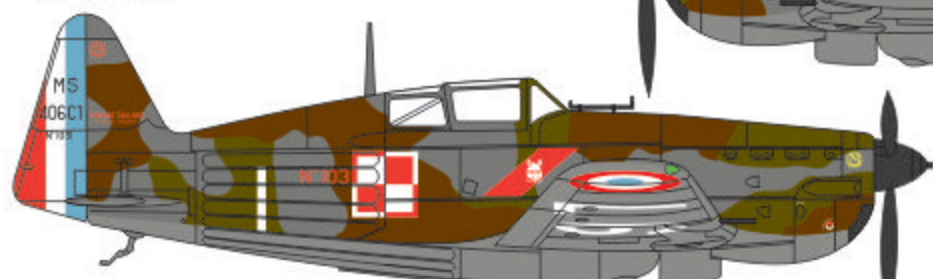
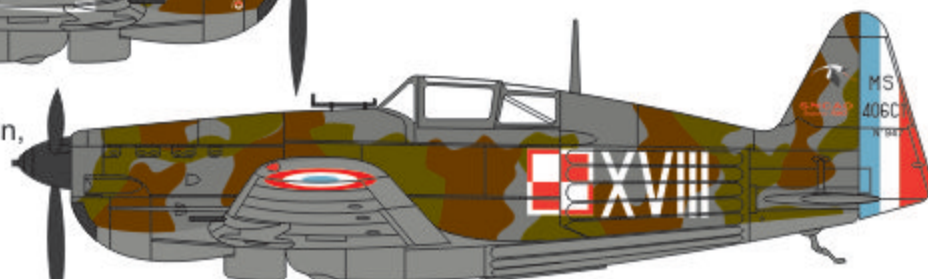

No.1031 "I", GC III/1, Rouen-Boos,
por. Kazimierz Bursztyn, April 1940.

No.948 "III", GC III/1, Rouen-Boos,
ppor. Władysław Chciuk, April 1940.

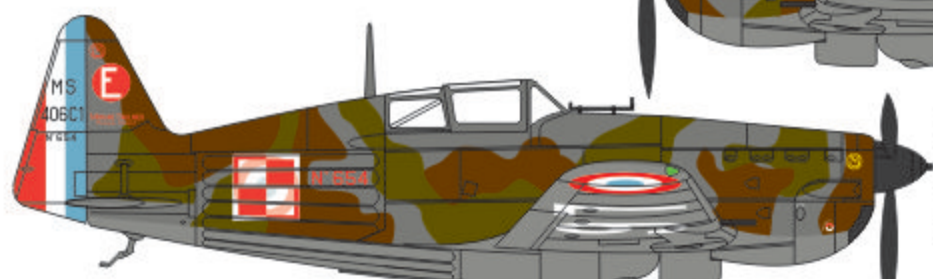
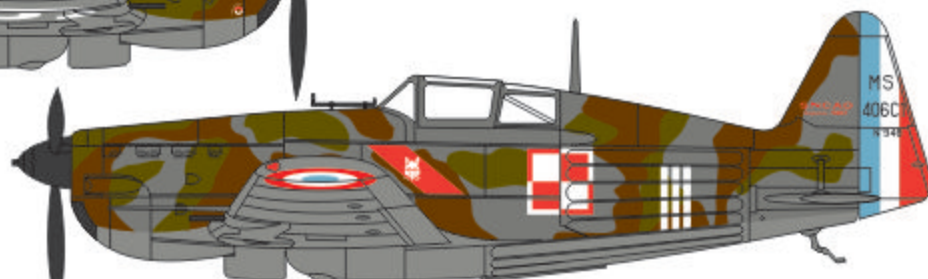

No.654 (L-683) "E", School Fighter Squadron
DIAP Lyon-Bron, ppor. Waclaw Król, ppor.
Stanisław Chałupa, sierż. Leopold Flanek,
spring 1940.

No.1038 (L-628), School Fighter Squadron
DIAP Lyon-Bron, por. Aleksander Gabszewicz,
June 1940.

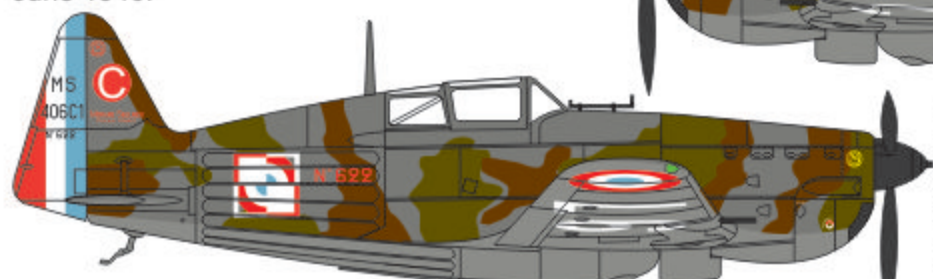
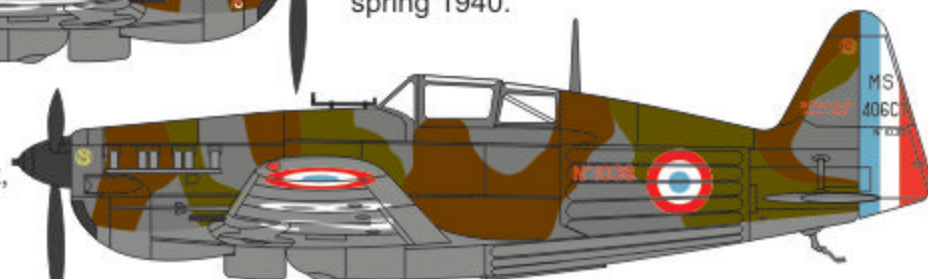

No.622 (L-651) "C", School Fighter Squadron
DIAP Lyon-Bron, Clermont Ferrand,
ppor. Waclaw Król,
ppor. Władysław Chciuk,
ppor. Stanisław Chałupa, June 1940.



48083

1 No.949 (L-980) "15", GC I/2 Xaffevillers, por. Józef Brzeziński, April 1940.

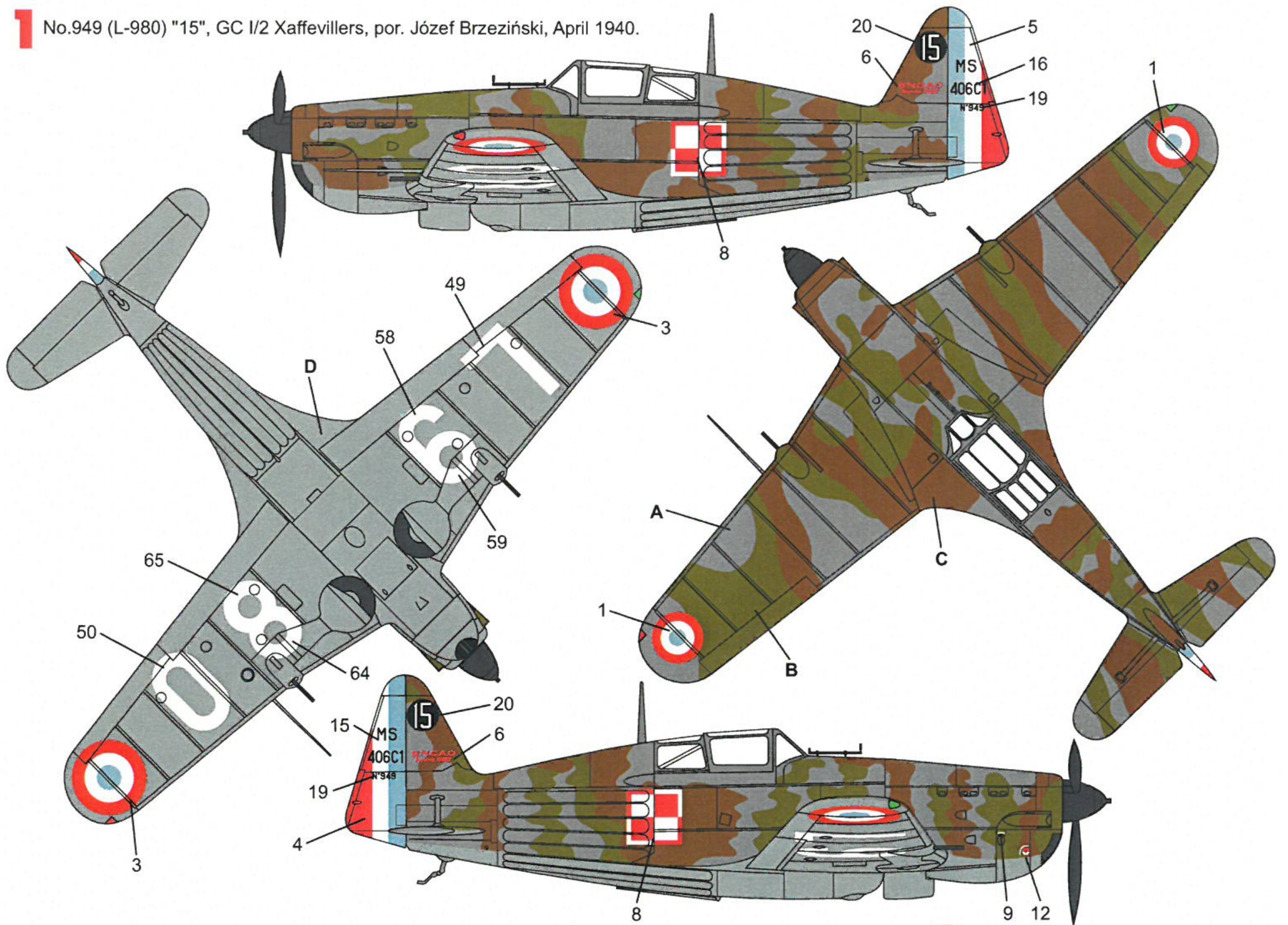

2 No.991 (L-720), GC I/2 Coulommiers, ppor. Stanisław Chałupa, 8 of June 1940.

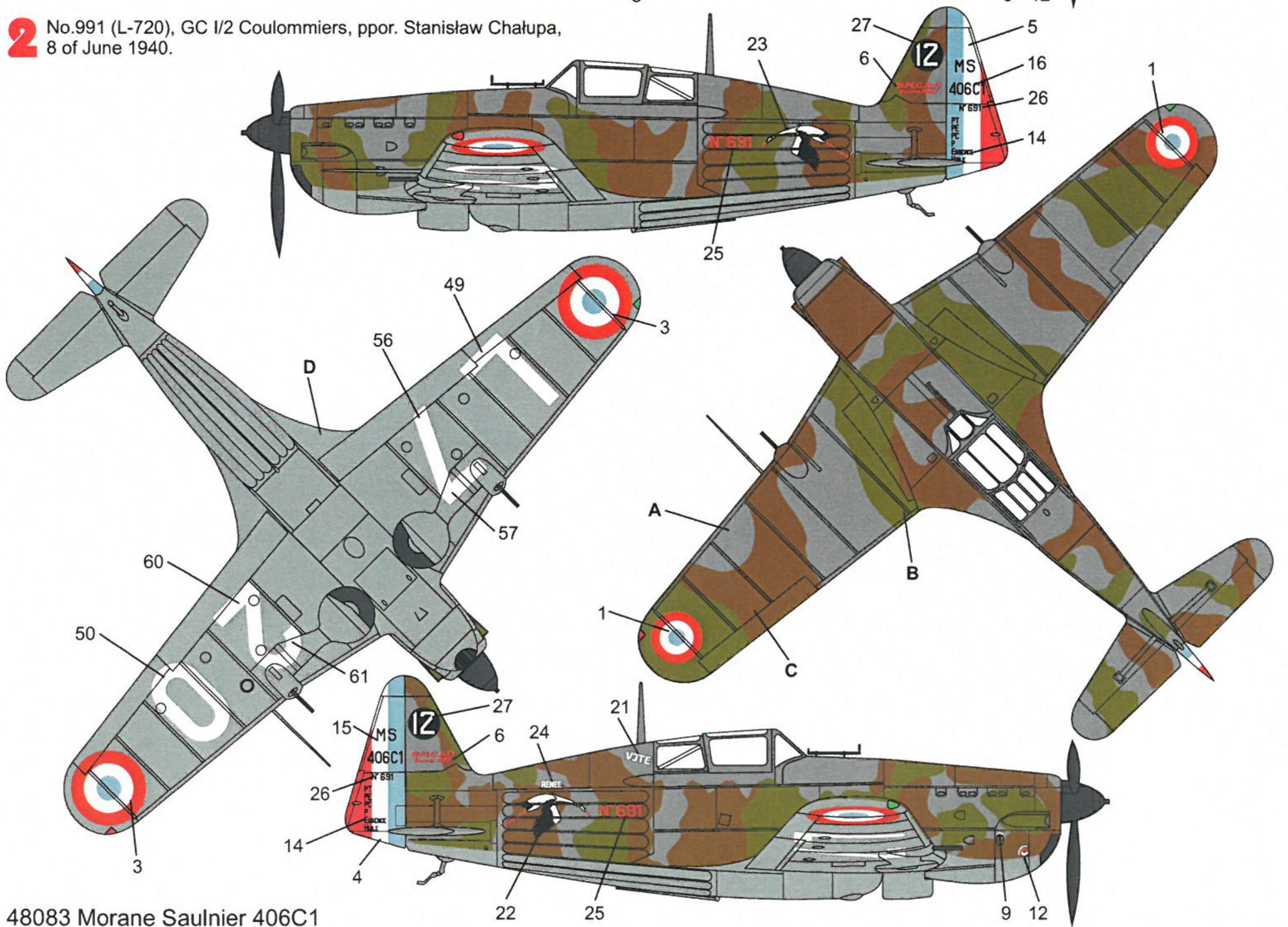

Masks application

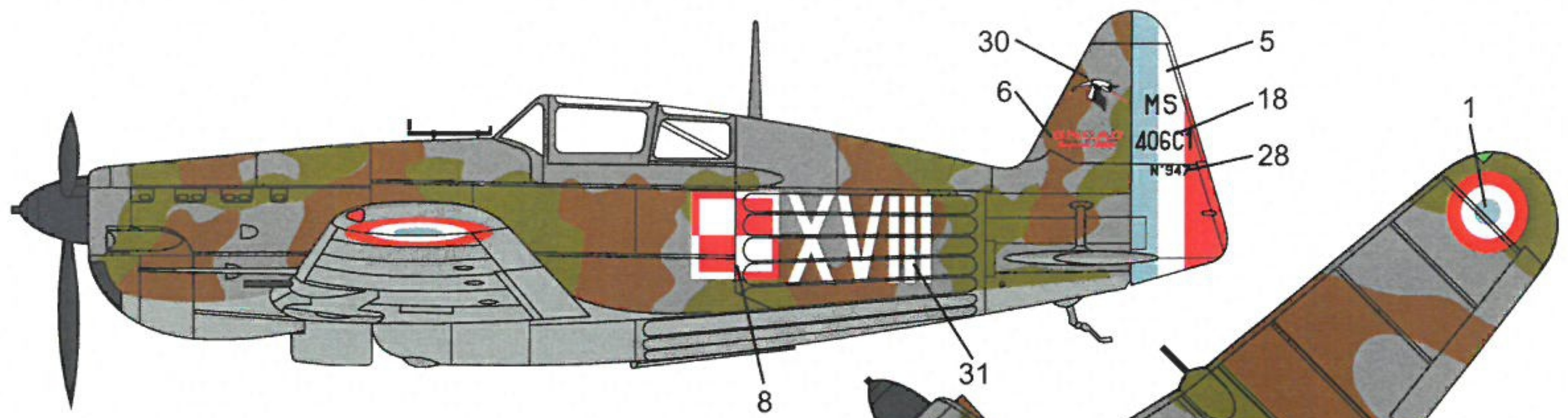
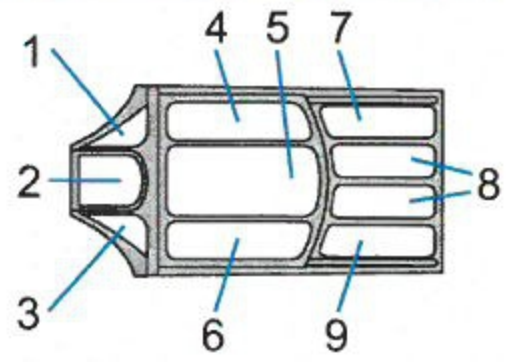
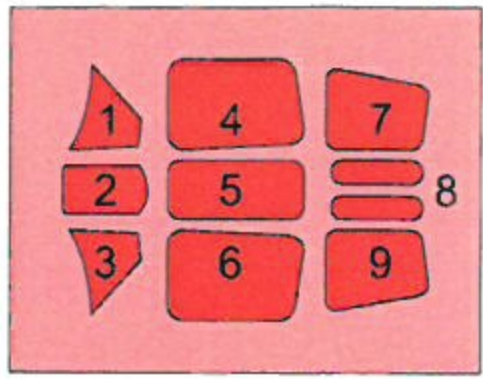

3 No.947 "XVIII", GC I/2, Dambin, plut. Antoni Beda, April 1940.

Reference:

1. Bartłomiej Belcarz, "Montpellier Fighter Squadron", Mushroom Model Magazine Special No.7108,
2. Bartłomiej Belcarz, "Morane MS 406 C1, caudron CR 714 C1 Cyclone, Bloch MB 151/152 C1", Polskie Skrzydła 2, Stratus 2004.
3. "L'armee de L'air 1939-1942", Wing Master No.1 Hors Serie.

Tabela kolorów:
Colors:

A	Gris bleu fonce	FS36270
B	Kaki	FS34127
C	Terre foncee (marron)	FS30140
D	Gris bleu clair	FS36230

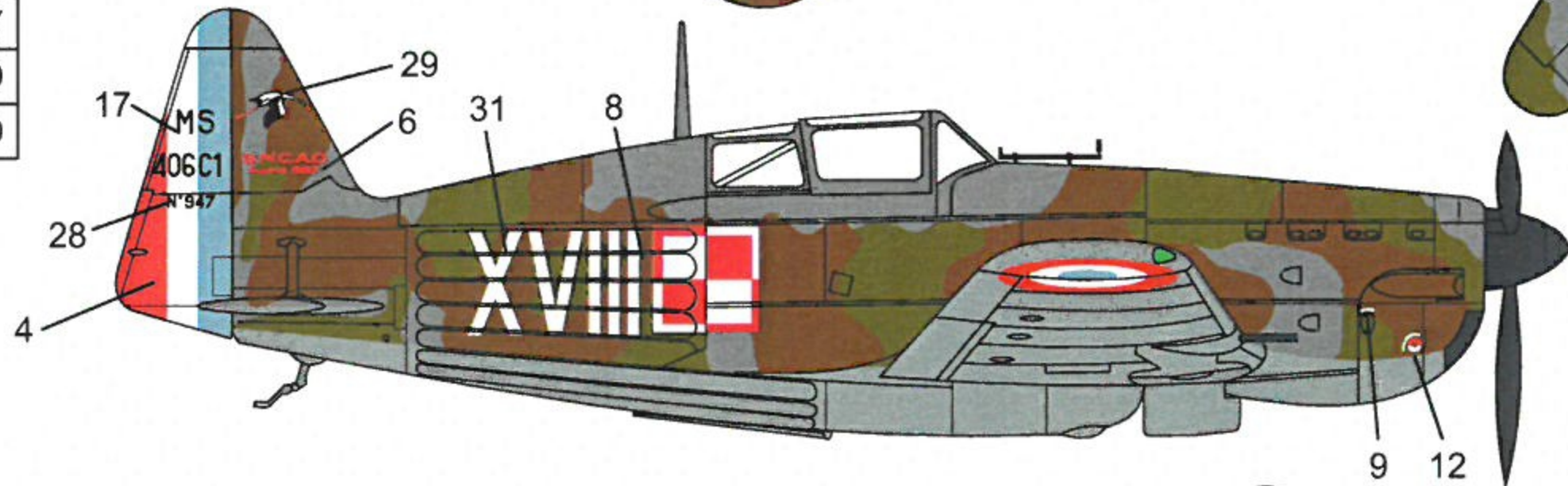

4 No.1031 "I", GC III/1, Rouen-Boos, por. Kazimierz Bursztyn, April 1940.

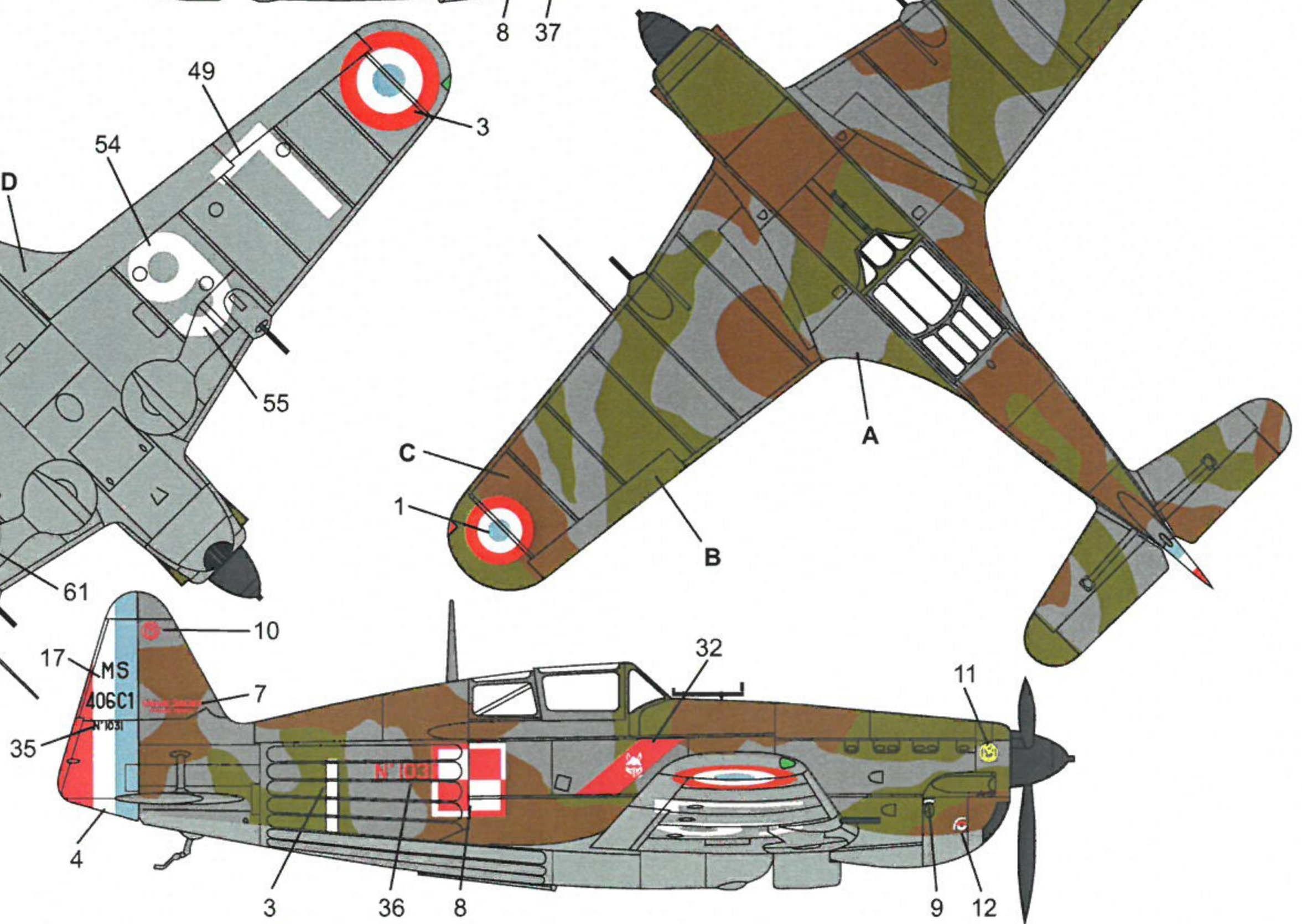
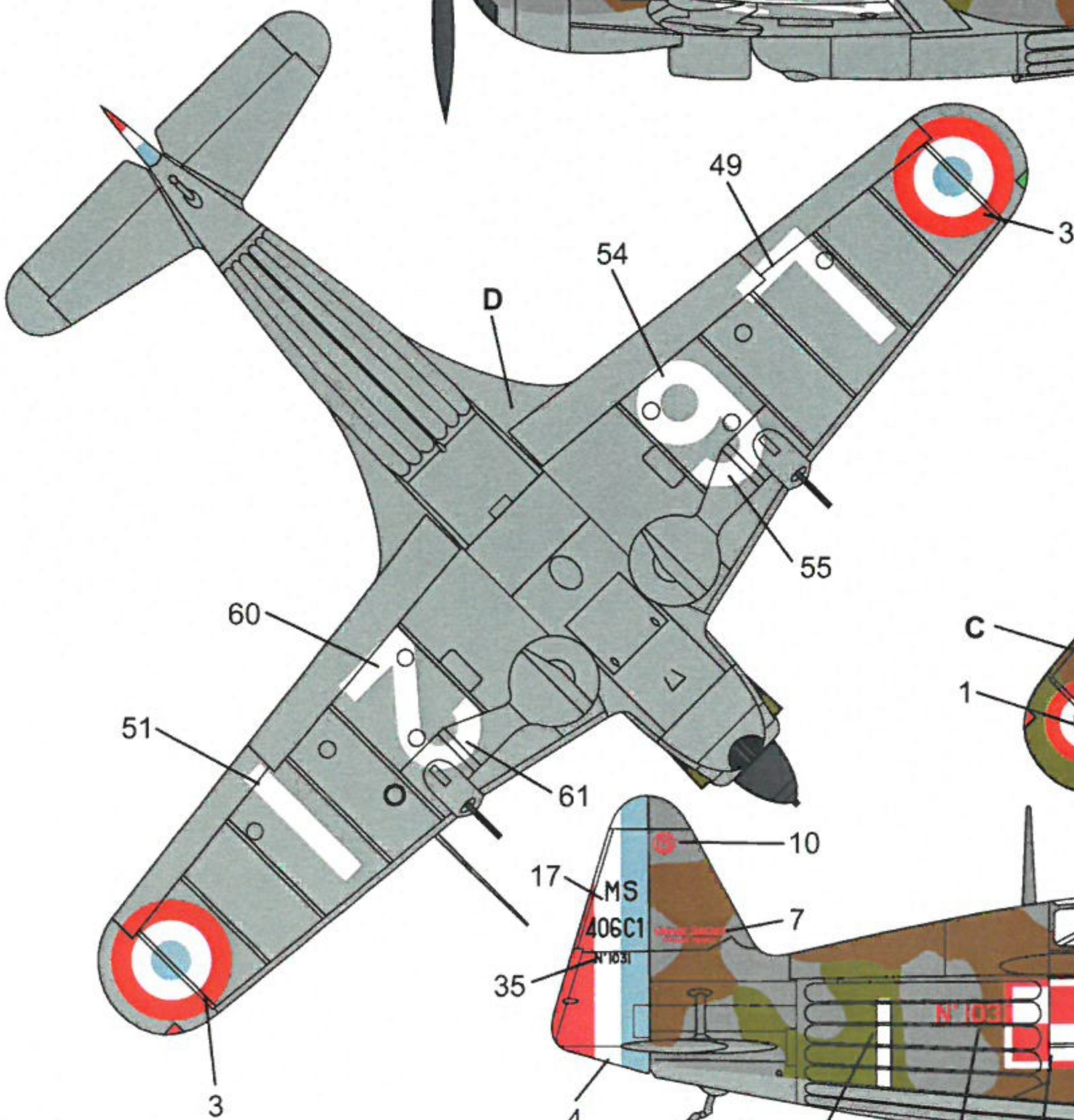
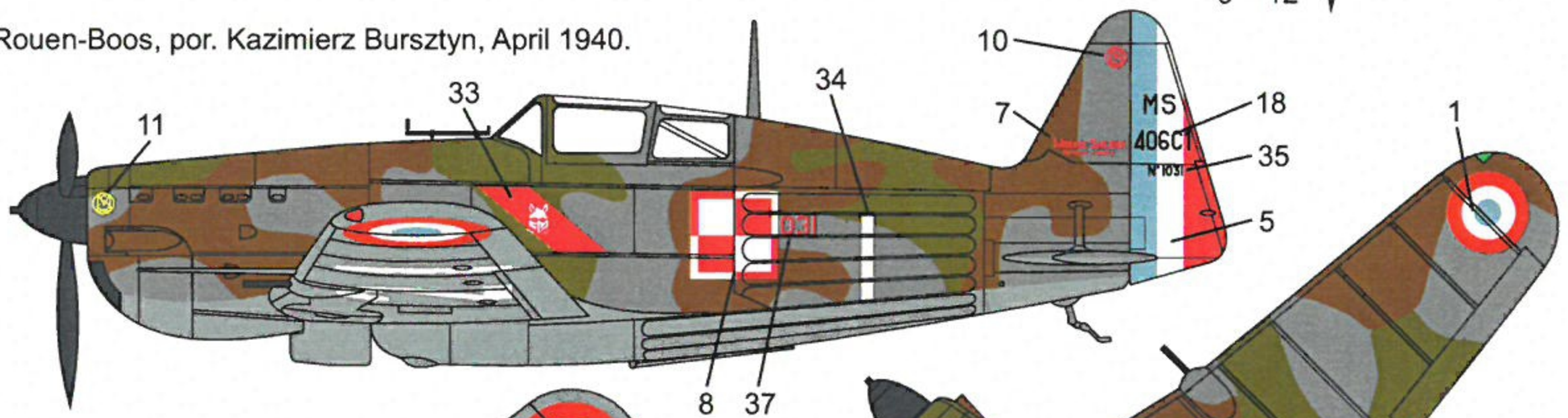

5 No.948 "III", GC III/1, Rouen-Boos, ppor. Władysław Chciuk, April 1940.

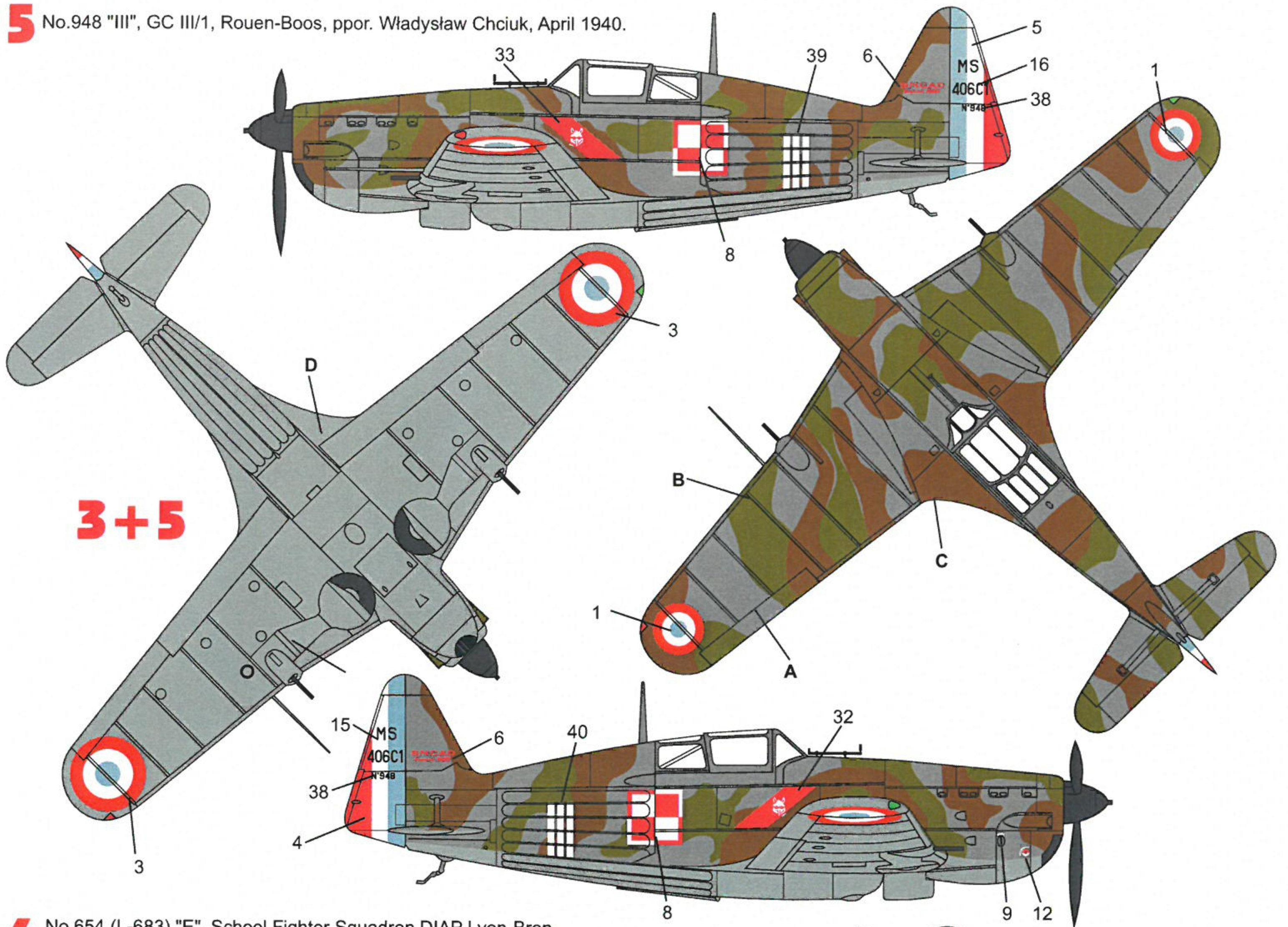

6 No.654 (L-683) "E", School Fighter Squadron DIAP Lyon-Bron, ppor. Wacław Król, ppor. Stanisław Chałupa, sierż. Leopold Flanek, spring 1940.

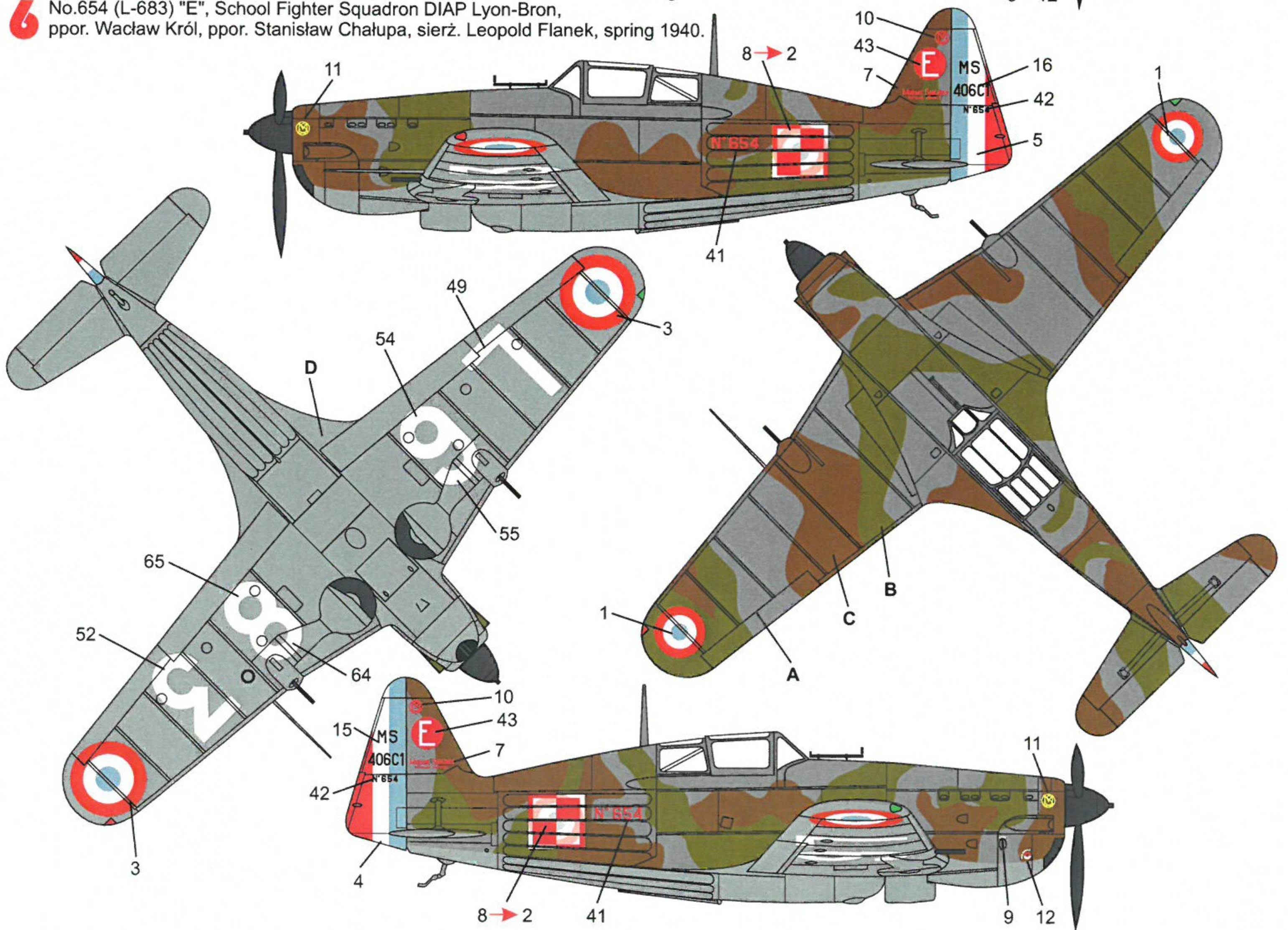

7 No.1038 (L-628), School Fighter Squadron DIAP Lyon-Bron, por. Aleksander Gabszewicz, June 1940.

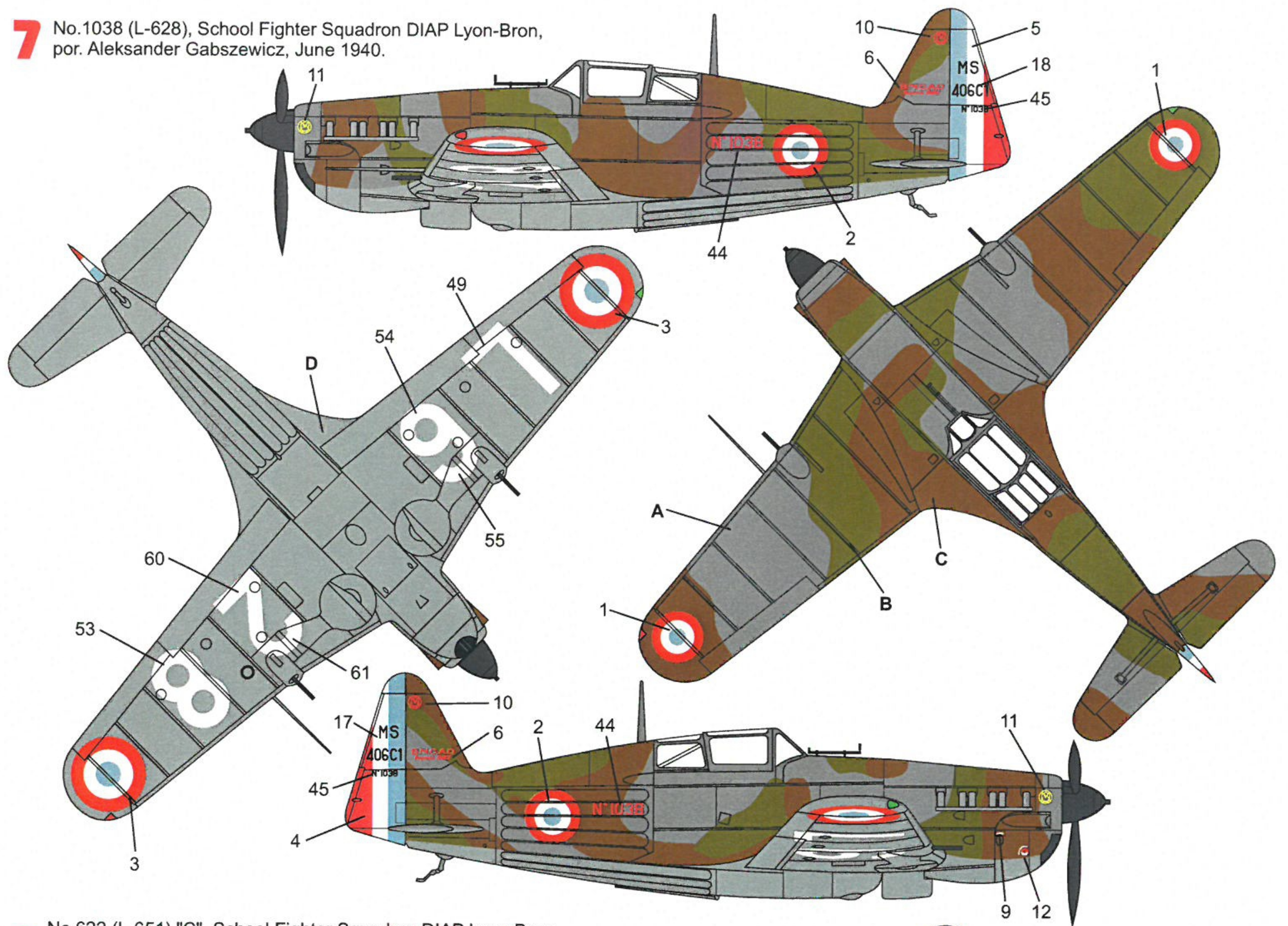

8 No.622 (L-651) "C", School Fighter Squadron DIAP Lyon-Bron, Clermont Ferrand, ppor. Wacław Król, ppor. Władysław Chciuk, ppor. Stanisław Chałupa, June 1940.

