

# SKY MODELS

SKYMODELS  
 VIA DEI VELIERI 142  
 00121 - ROME - ITALY  
 PH. & FAX 0039 6 5674110  
 E-MAIL: skymodels@tiscalinet.it  
 VISIT OUR WEB SITE:  
 web.tiscalinet.it/skymodels

## MACCHI MC 205

1/48<sup>TH</sup> SCALE  
 48 - 020

GLI SCHEMI MIMETICI SONO RIFERITI AL LIBRO: CAMOUFLAGE SCHEMES ARE REFERED AT THE BOOK: "COLORI E SCHEMI MIMETICI DELLA REGIA AERONAUTICA 1939-1943 DI POSTIGLIONI & DEGL'INNOCENTI DEL GMT. CMPR. GAVS

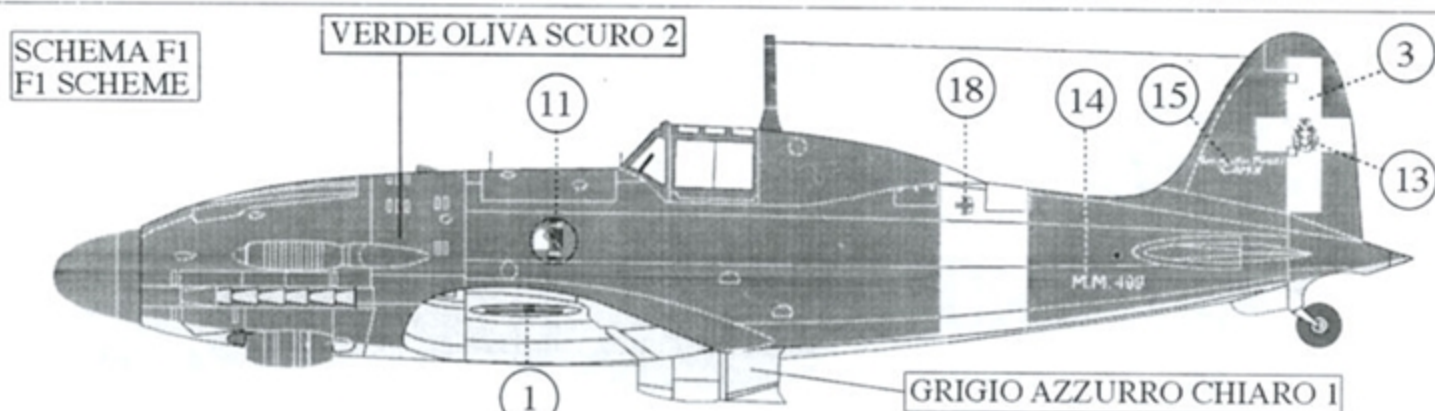

Macchi MC 205N - MM.499 Prototipo, Lonate Pozzolo

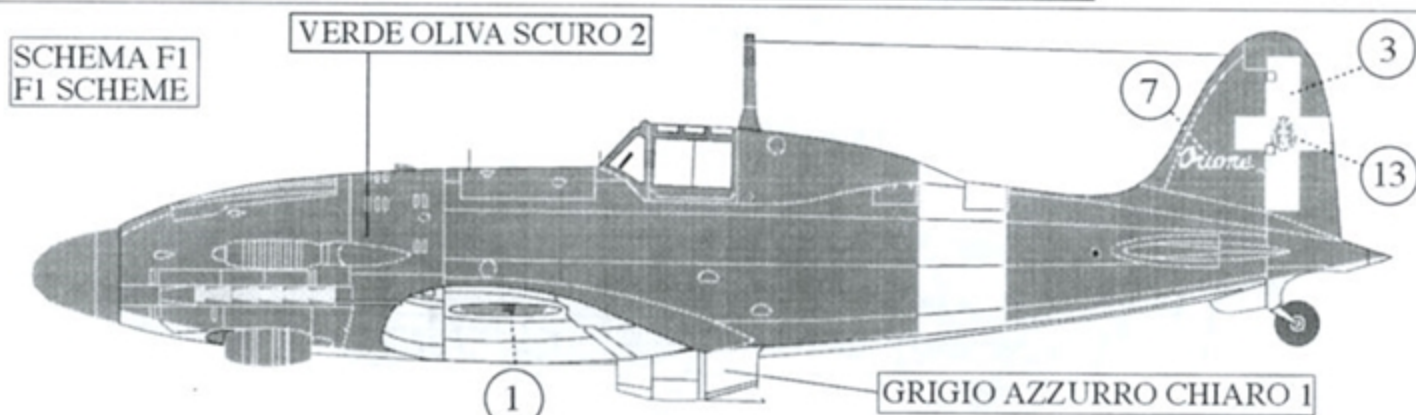

Macchi MC 205N - MM.500 2° Prototipo

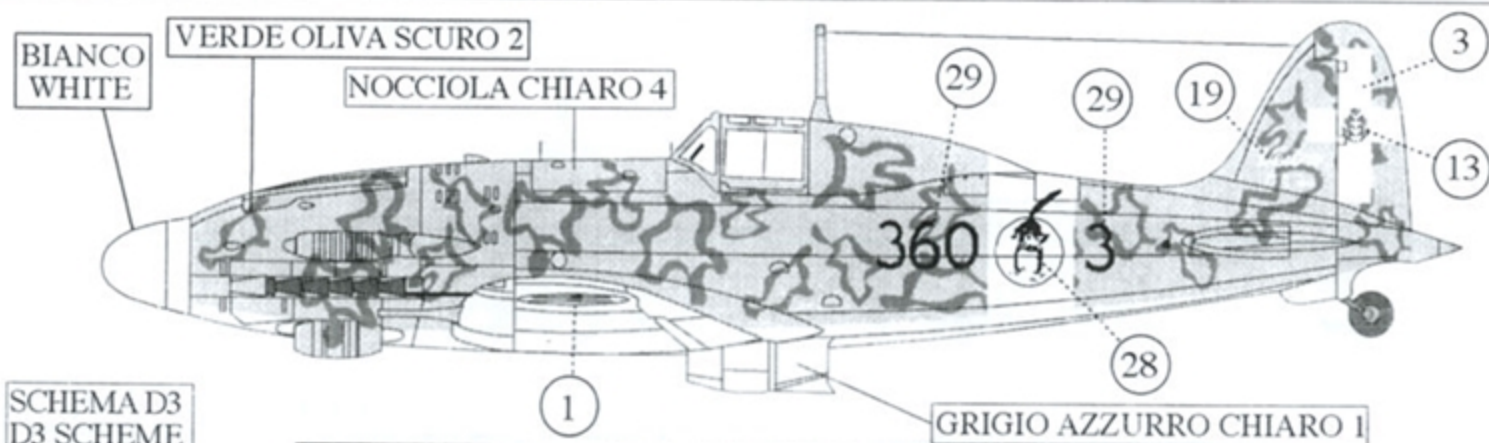

Macchi MC 205 - MM.9291 - 360<sup>A</sup> Sq.155° Gr.51° St.Sardinia, summer 1943

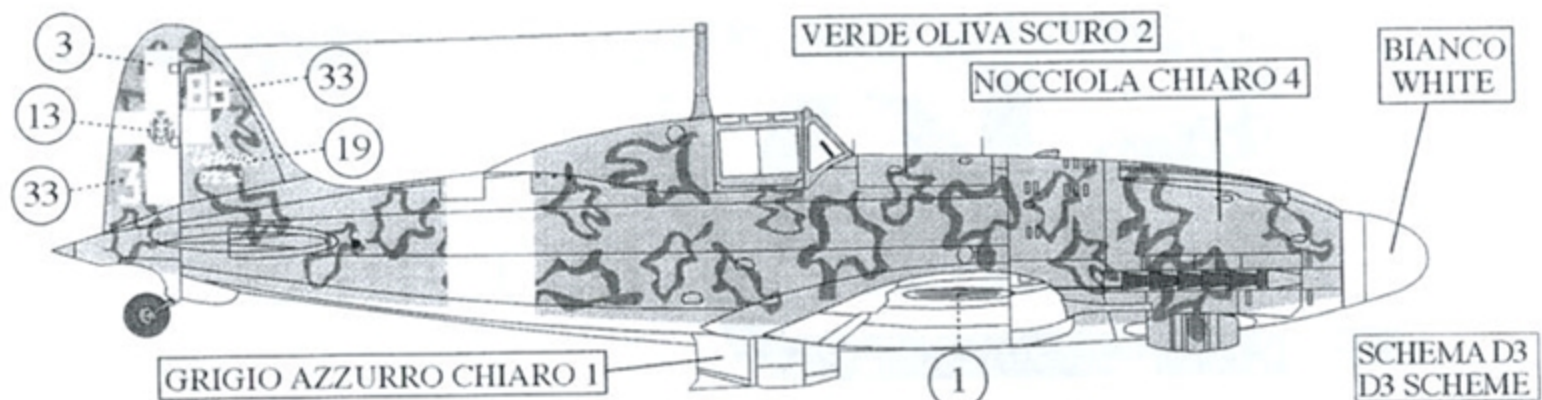

**Macchi MC 205 - 85<sup>a</sup>Sq. 18<sup>o</sup>Gr. 3<sup>o</sup>St. 1943**

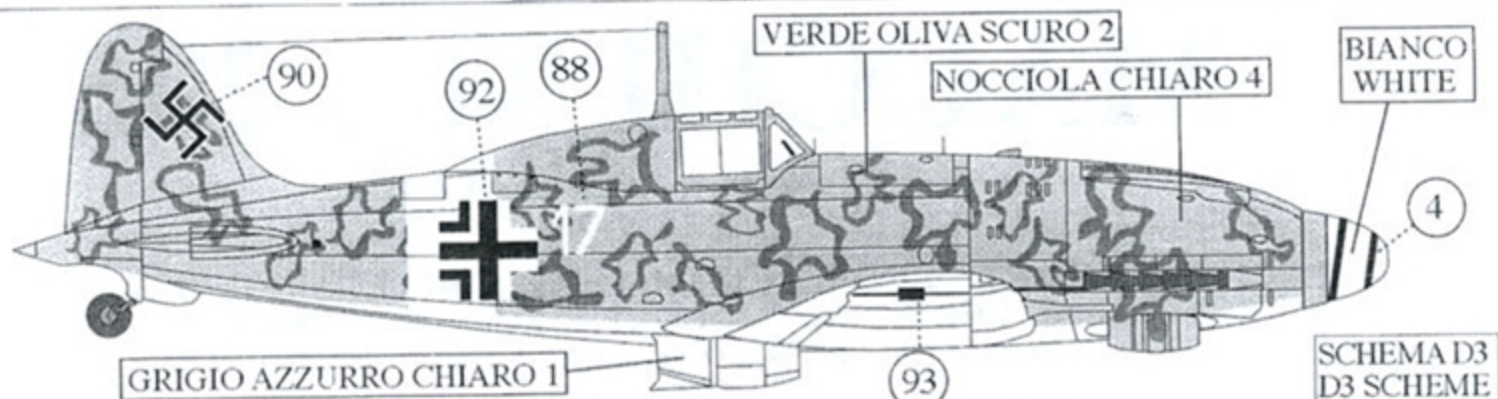

**MACCHI MC 205 - JG 77 - Italy, 1943**

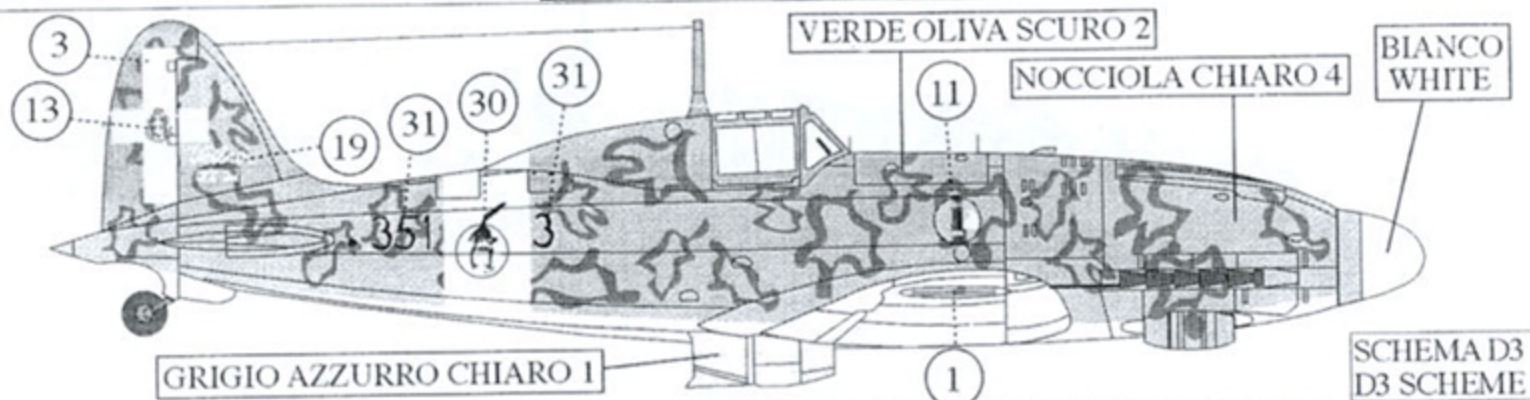

**MACCHI MC 205 - 351<sup>a</sup>Sq. 51<sup>o</sup> St. - Sardinia, summer 1943**

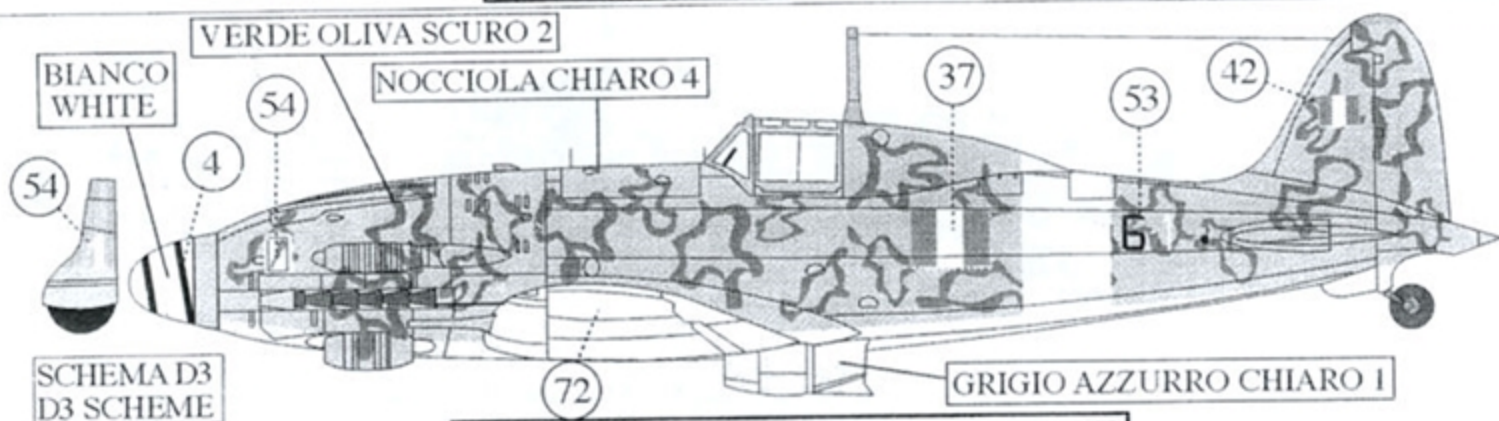

**MACCHI MC 205 V - 1<sup>a</sup>Sq. 1<sup>o</sup> Gr. Caccia ANR**

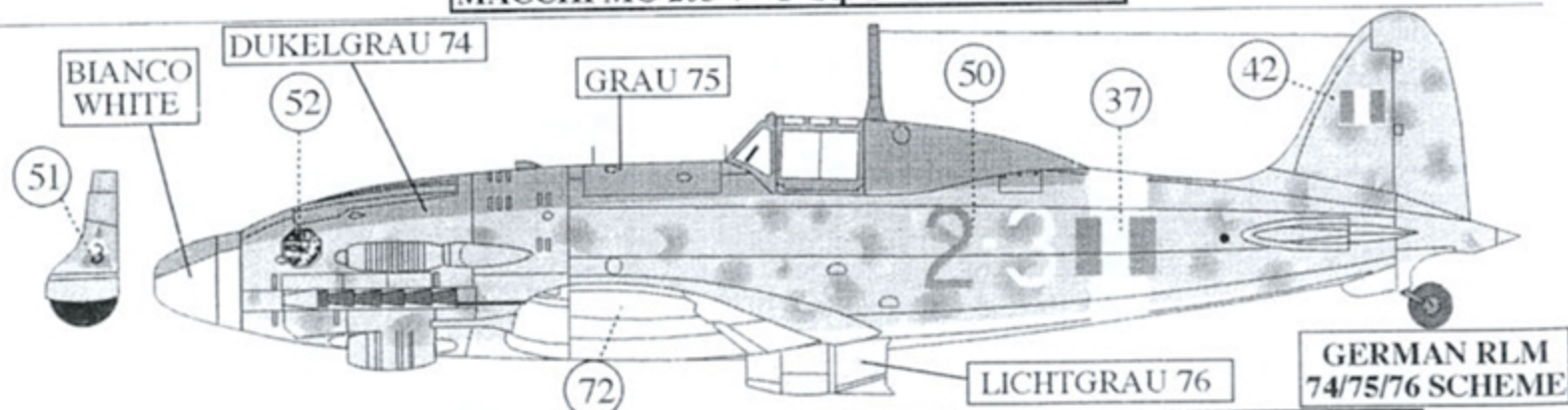

**MACCHI MC 205 V III Serie- 3<sup>a</sup>Sq. 1<sup>o</sup> Gr. Caccia ANR, Campodiformio, spring 1944**

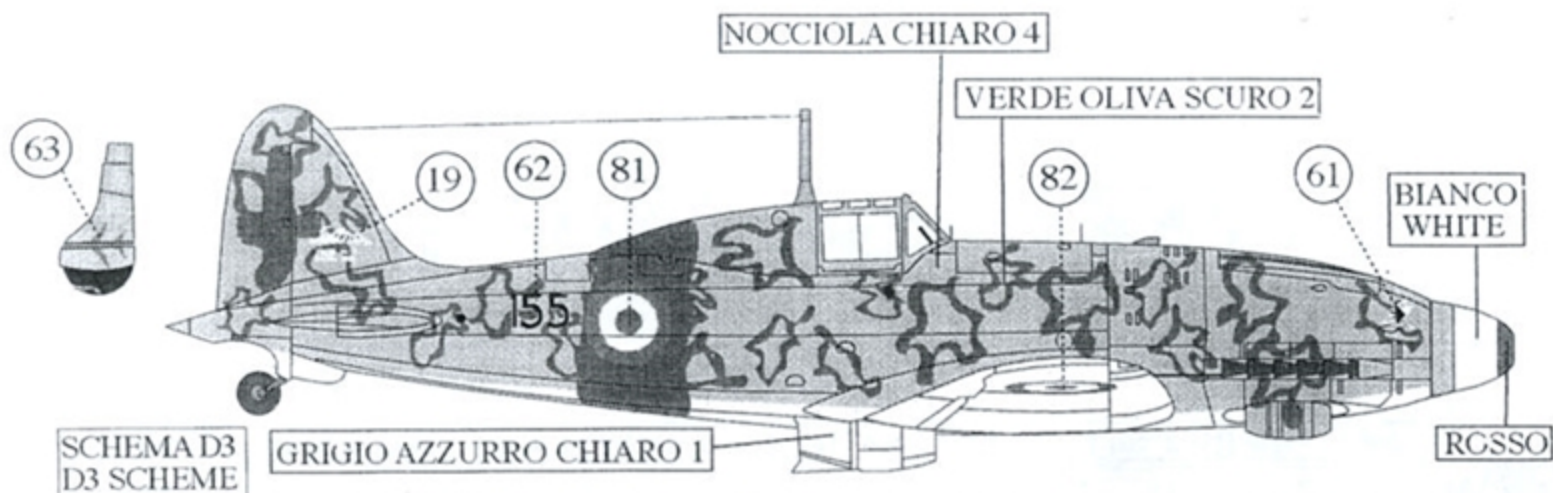

MACCHI MC 205 - MM.9348 CO-Belligerant A.F. Lecce-Galatina Autunno 1944

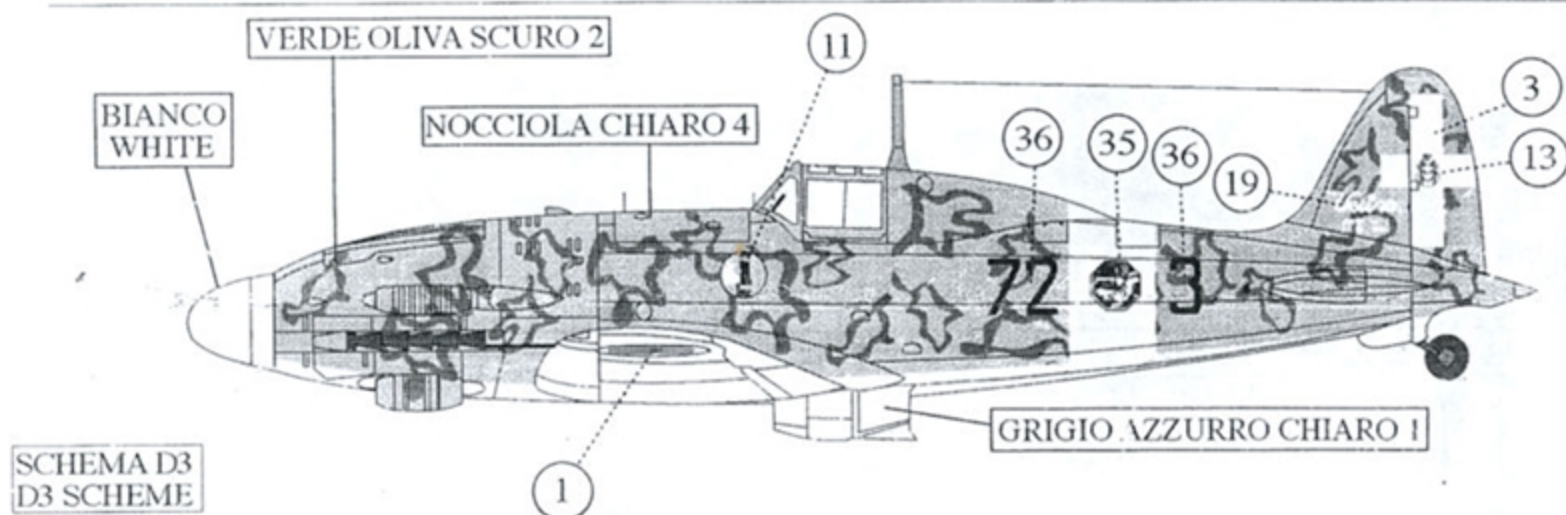

MACCHI MC 205V serie I - 72<sup>^</sup>Sq.

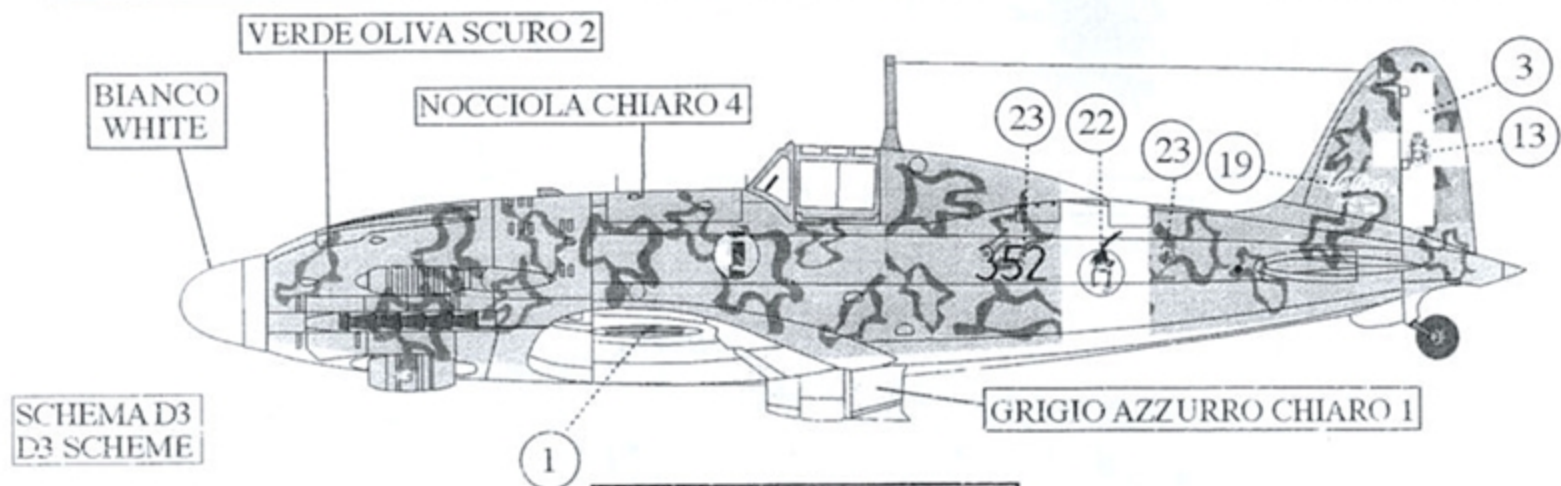

MACCHI MC 205V - 352<sup>^</sup>Sq.

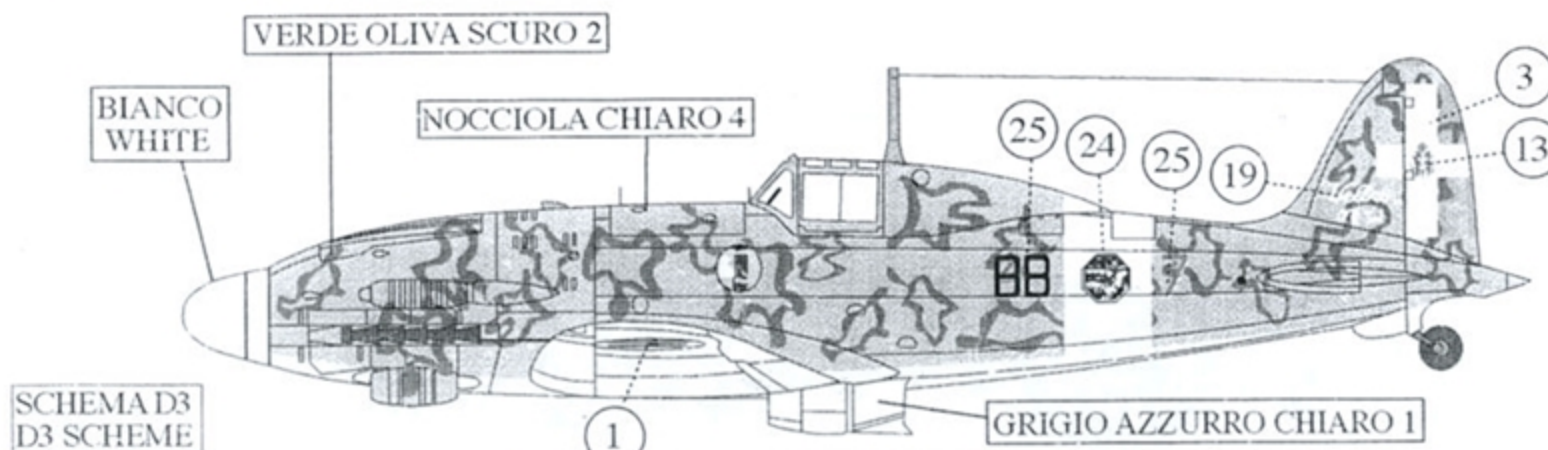

MACCHI MC 205V serie I, MM.9313 - 88<sup>^</sup>Sq. 1<sup>o</sup> St. Sicily 1943

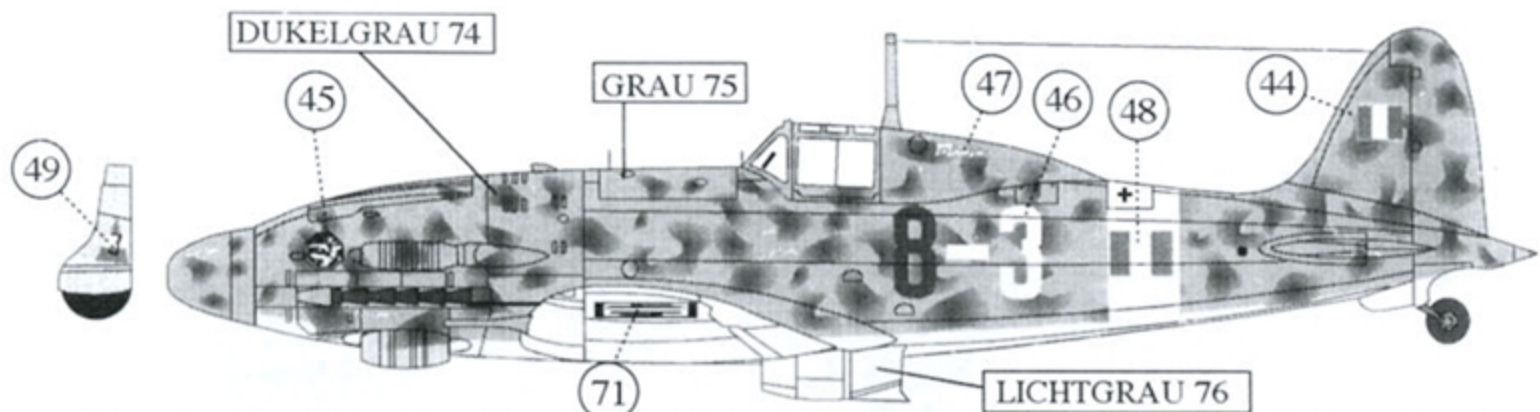

MC 205 V Serie III- 3<sup>^</sup>Sq.1<sup>o</sup> Gr. ANR,Pilot, Ten R.TALAMINI(1 score), Campodiformio, spring 1944

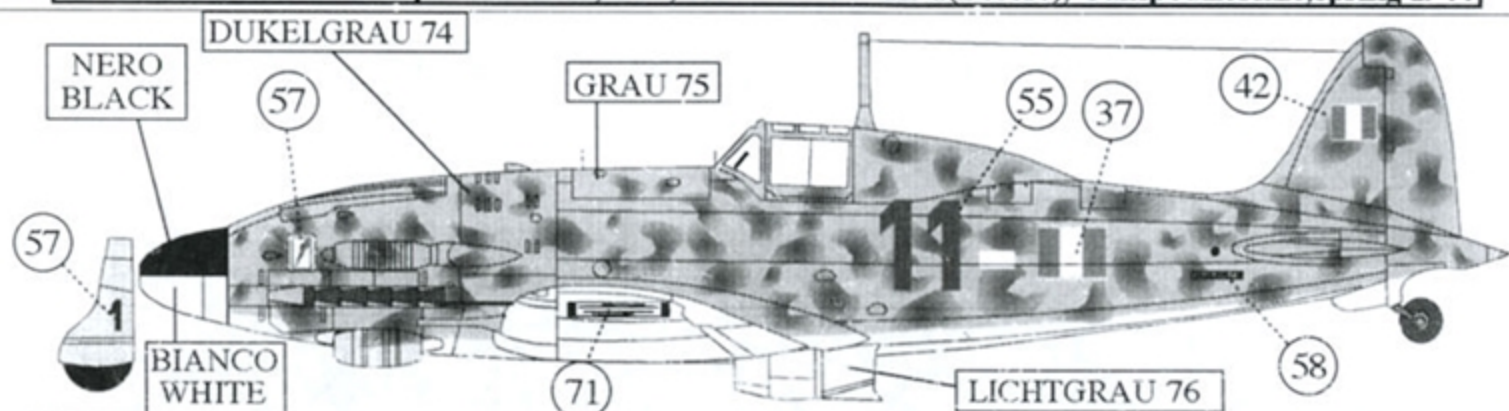

MC 205V, serie III,MM. 92266,1<sup>^</sup>Sq. 1<sup>o</sup>Gr.ANR,Pilot M.llo MAGNAGHI, (2 scores) Campodiformio 1944

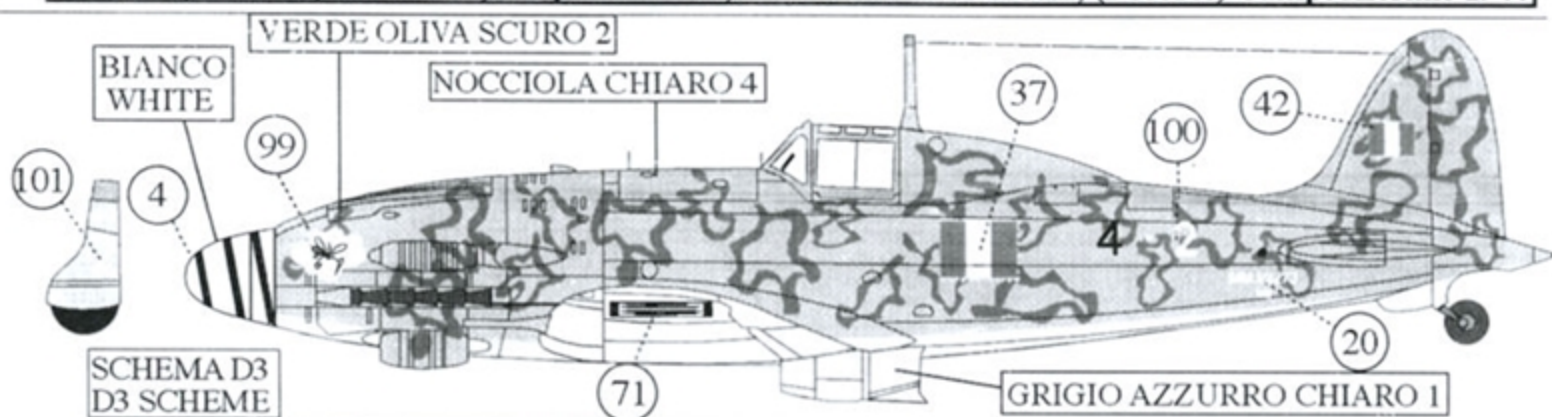

MACCHI C 205V serie III, MM.92273, 2<sup>^</sup>Sq.1<sup>o</sup>Gr.C.T.ANR, Campodiformio, January 1944

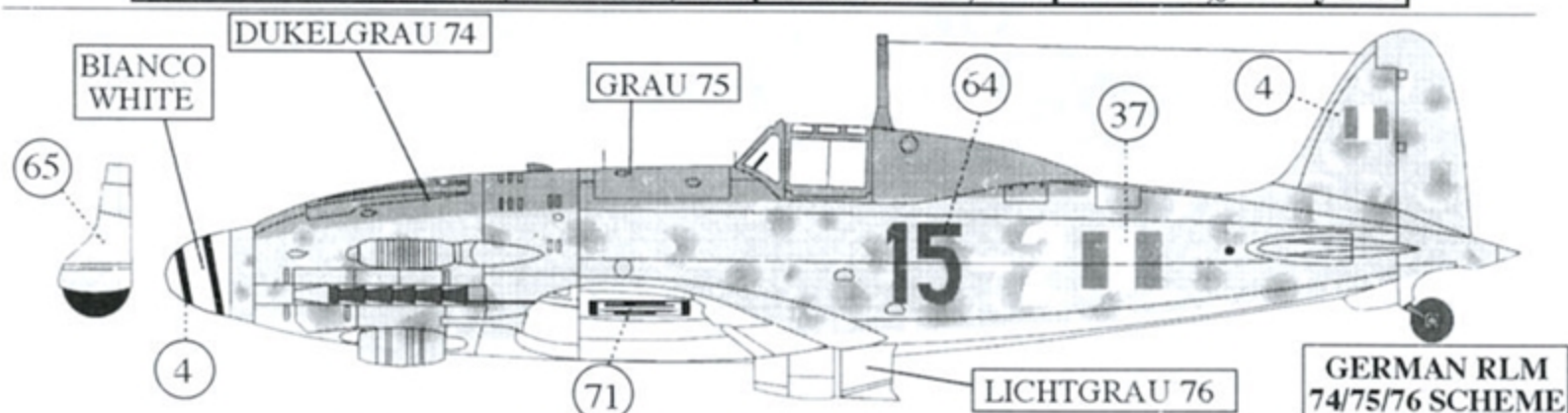

MACCHI C 205 serie III,MM.92276 - 2<sup>^</sup>Sq.1<sup>o</sup> Gr. C.Vicenza, July 1944

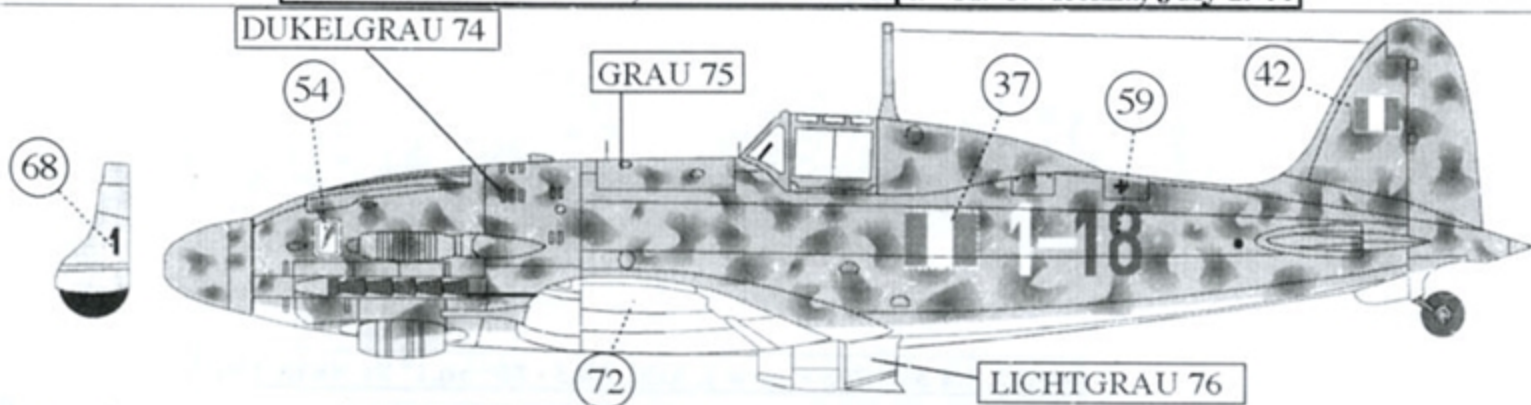

MACCHI C 205 V serie III, MM.92219, - 1<sup>^</sup>Sq.1<sup>o</sup> Gr.C.T.ANR

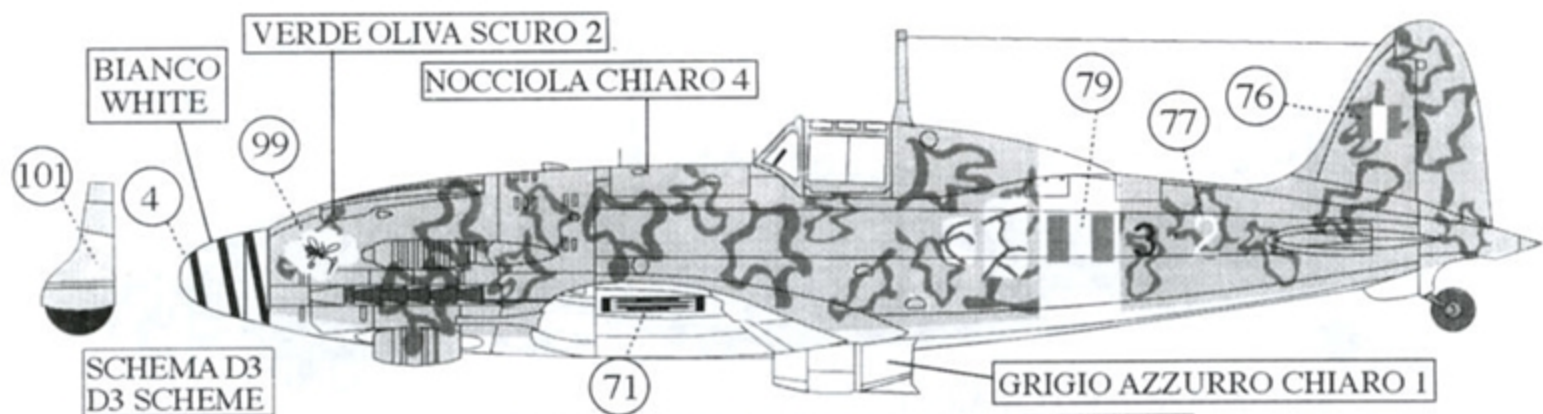

**MACCHI C205V serie III - 2<sup>a</sup>Sq.1<sup>o</sup>Gr. C.ANR.**

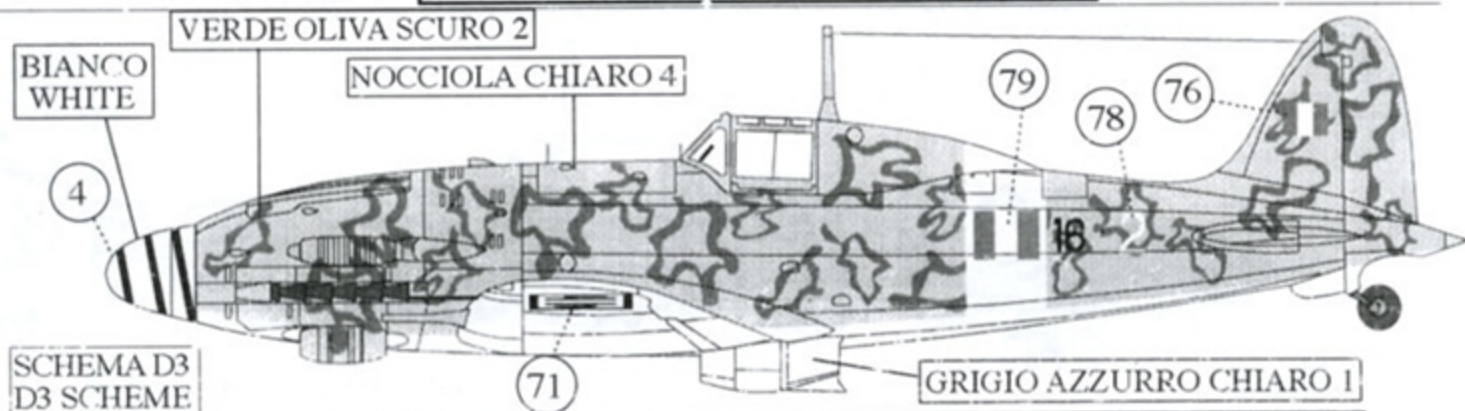

**MACCHI C205V serie III, 3<sup>a</sup>Sq.1<sup>o</sup>Gr.CT.ANR, Ten.pil.Oddone COLONNA (1score)**

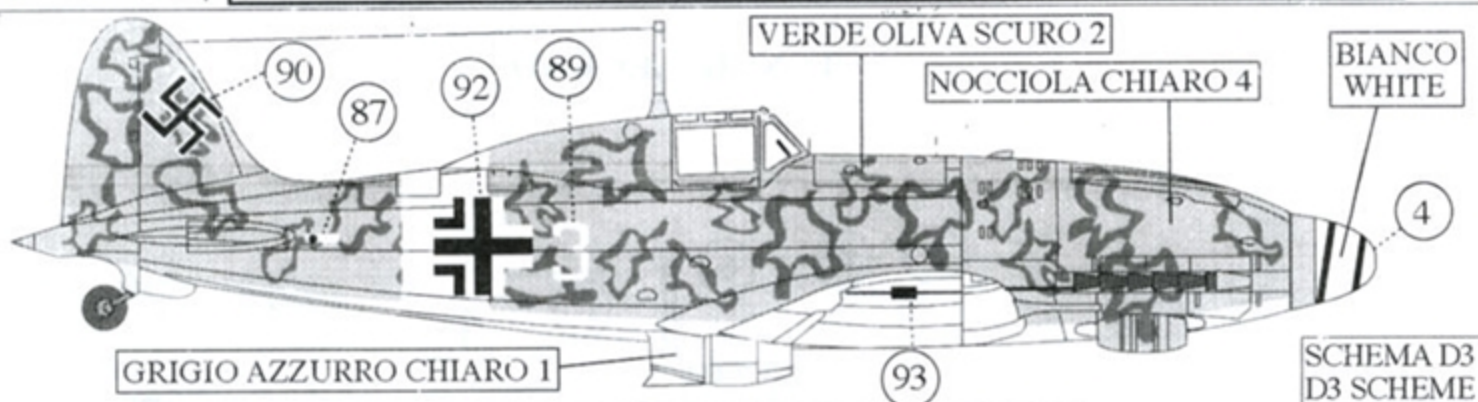

**MACCHI MC 205 - JG 77 - Italy, 1943**

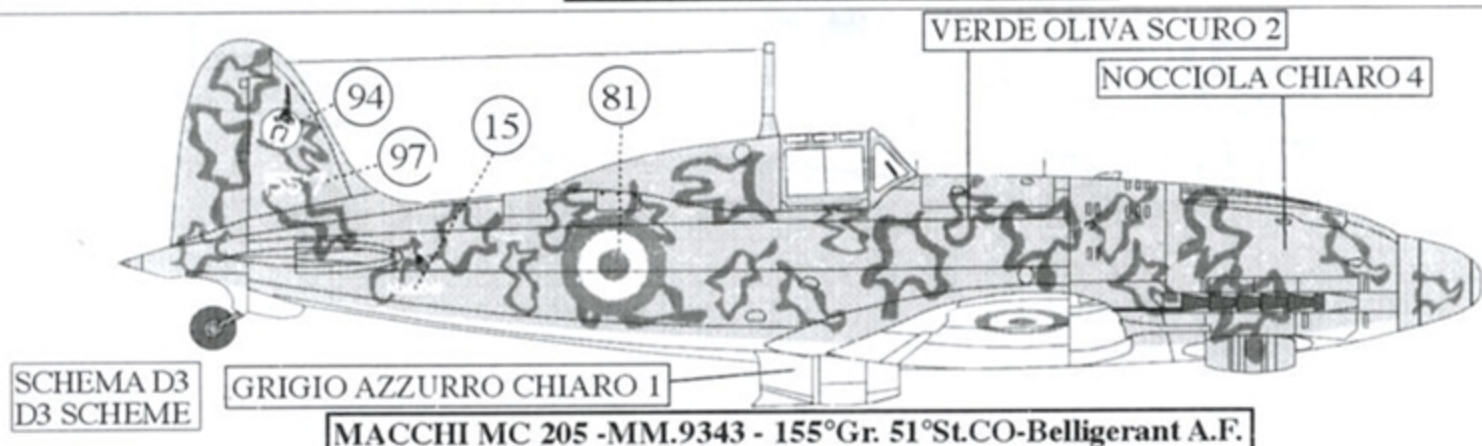

**MACCHI MC 205 -MM.9343 - 155<sup>o</sup>Gr. 51<sup>o</sup>St.CO-Belligerant A.F.**

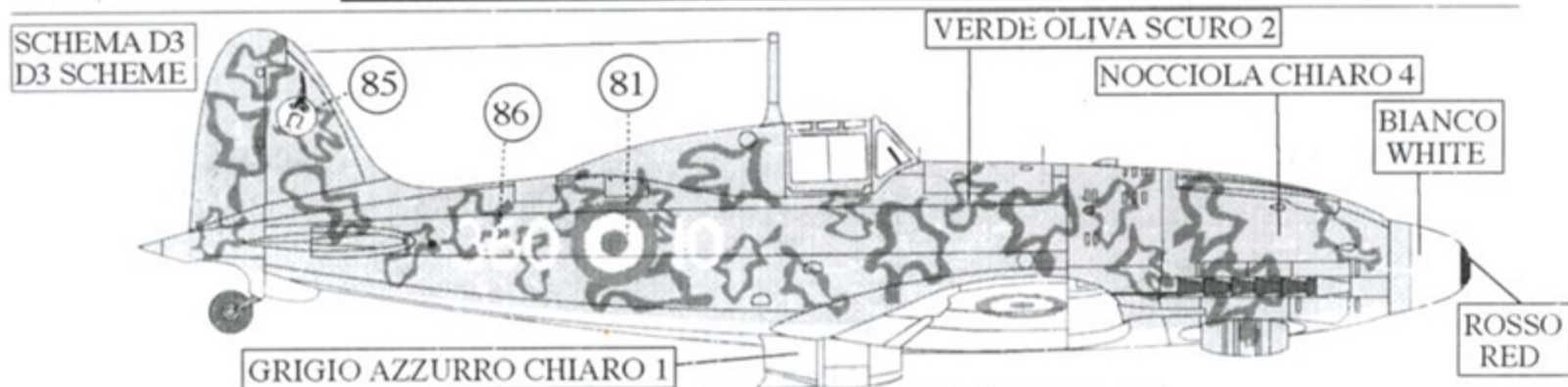

**MACCHI MC 205 -360<sup>o</sup>Gr. CO-Belligerant A.F.**

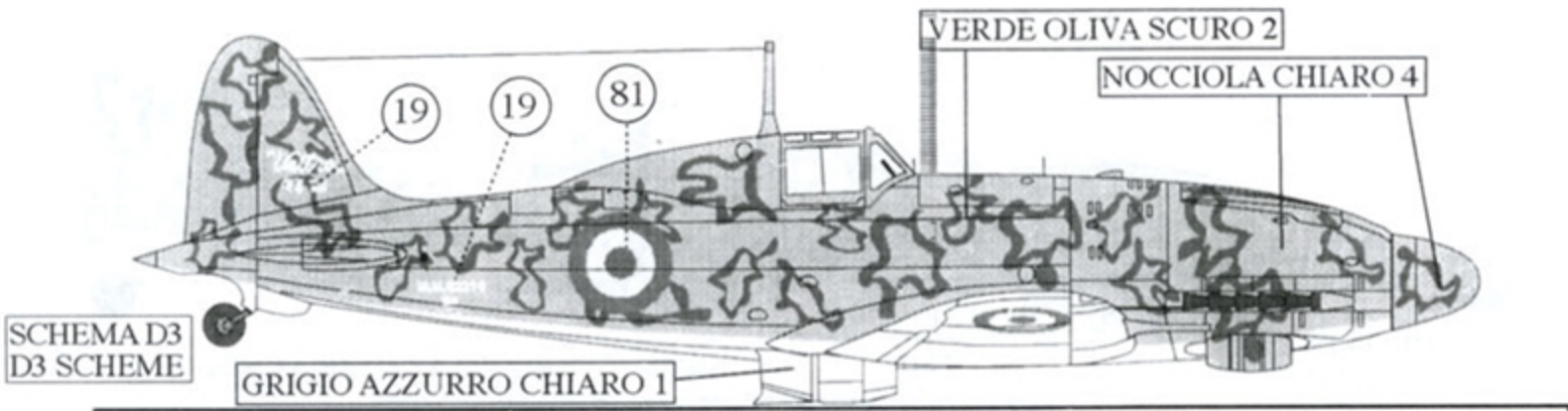

MACCHI C205V serie III, MM.92214 - Cap.Pil.MARIOTTI - Fly over occupied Rome, on October 6, 1943

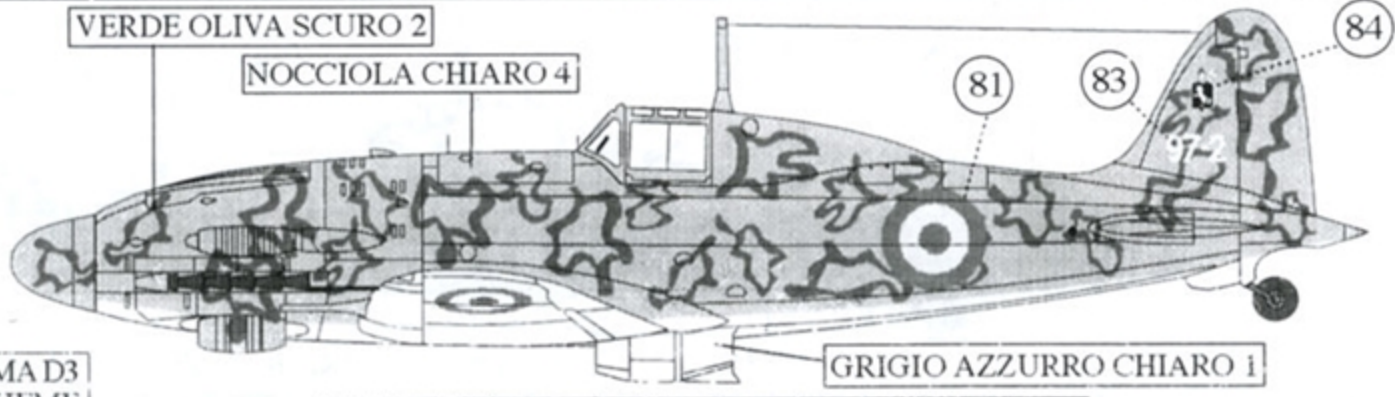

MACCHI C205V serie III - 97<sup>a</sup>Sq.Co-Belligerant A.F.

**STENCIL LEGEND**

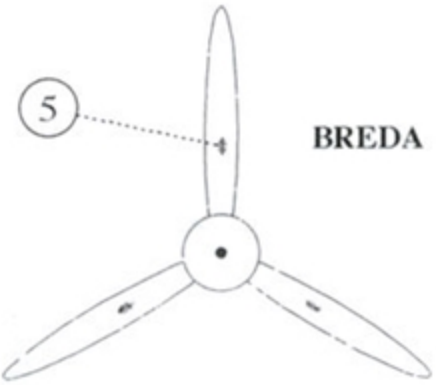
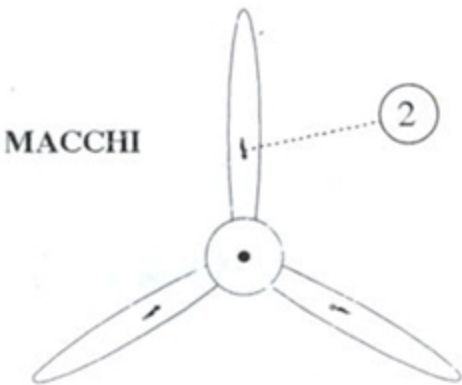
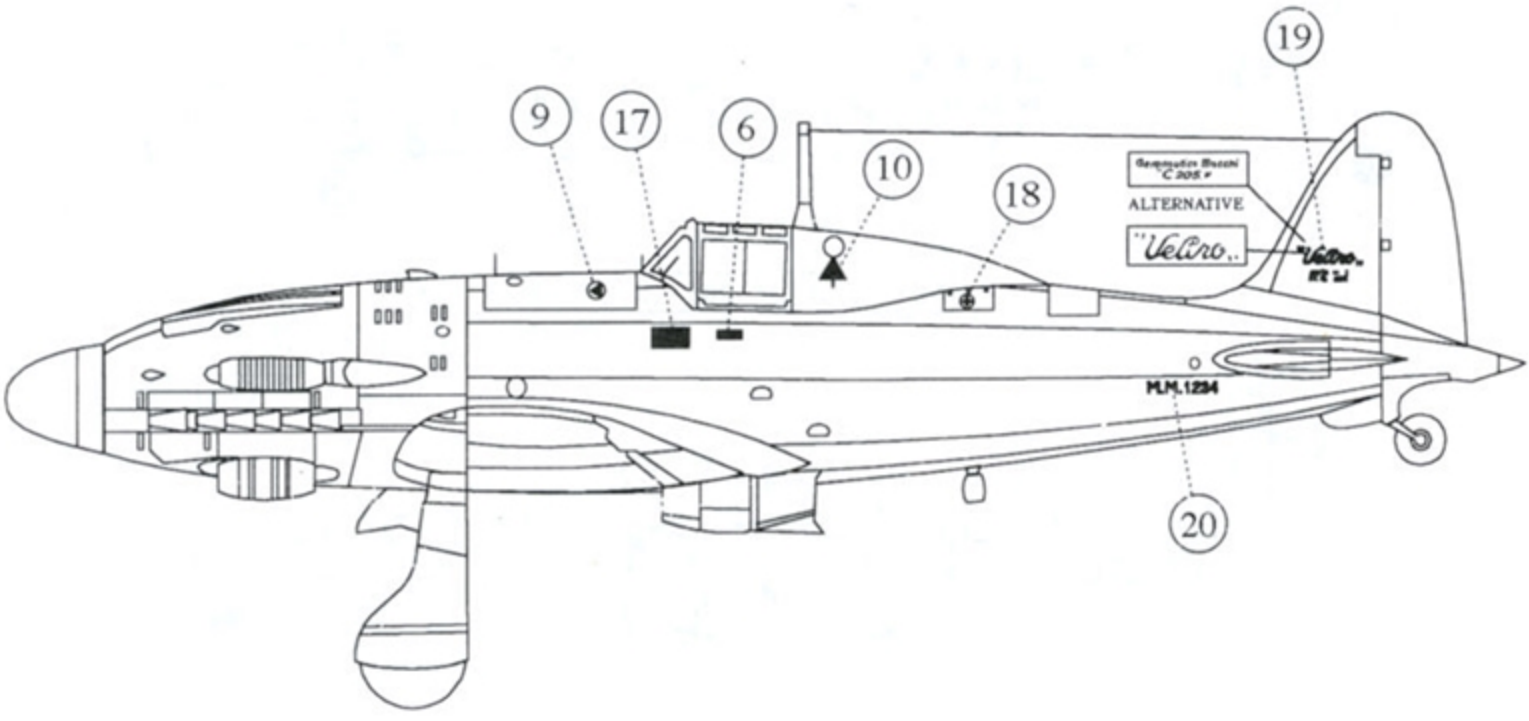

**PROPELLER INSIGNA**

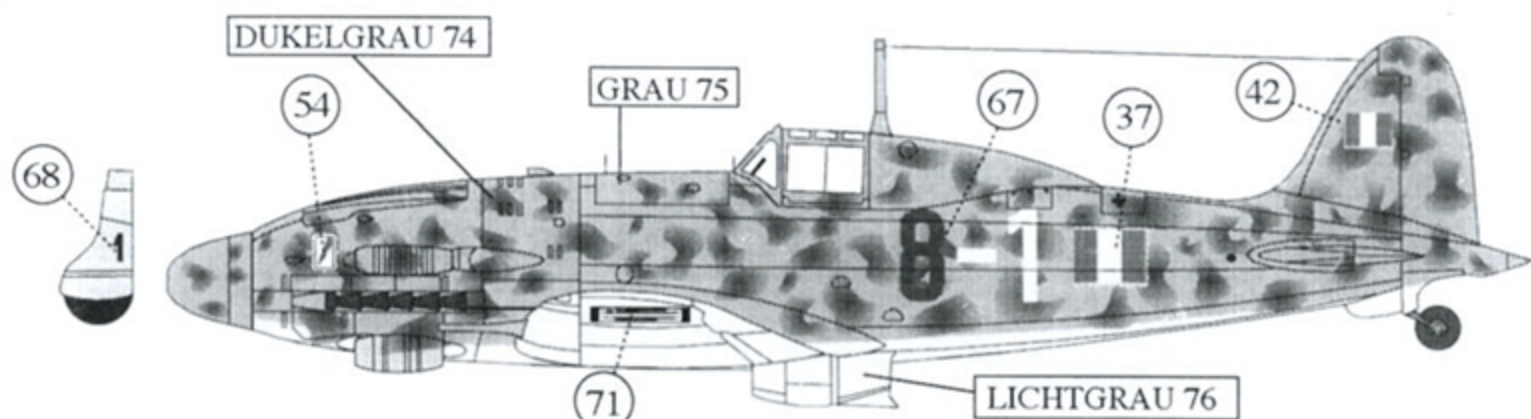

**MACCHI C 205V, 1<sup>a</sup>Sq. 1<sup>o</sup>Gr.C. ANR**

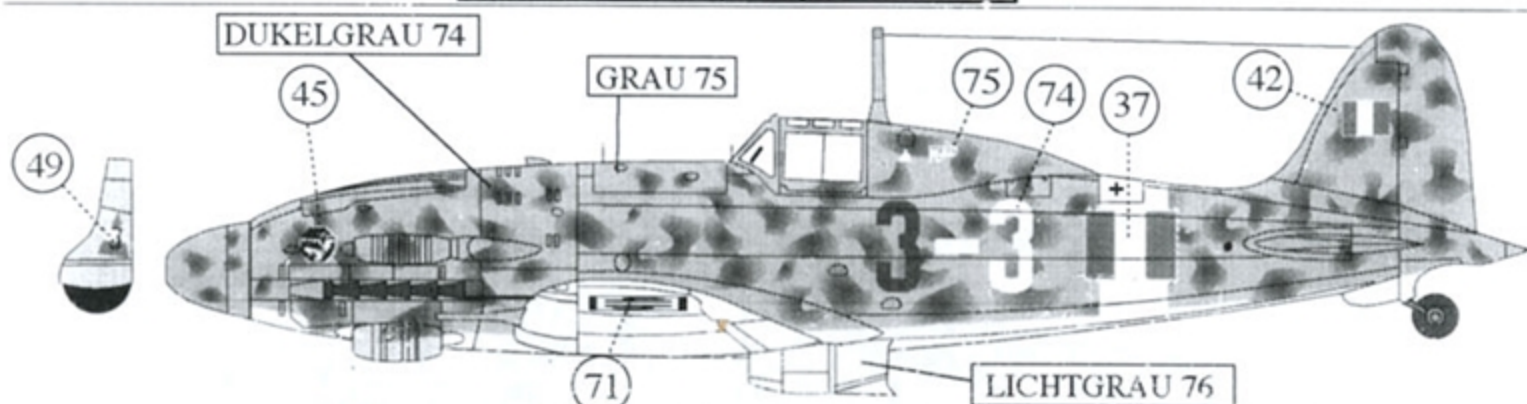

**MACCHI C205V serie III - 3<sup>a</sup>Sq.1<sup>o</sup>Gr.CT. ANR.Campodiformio, Spring 1944**

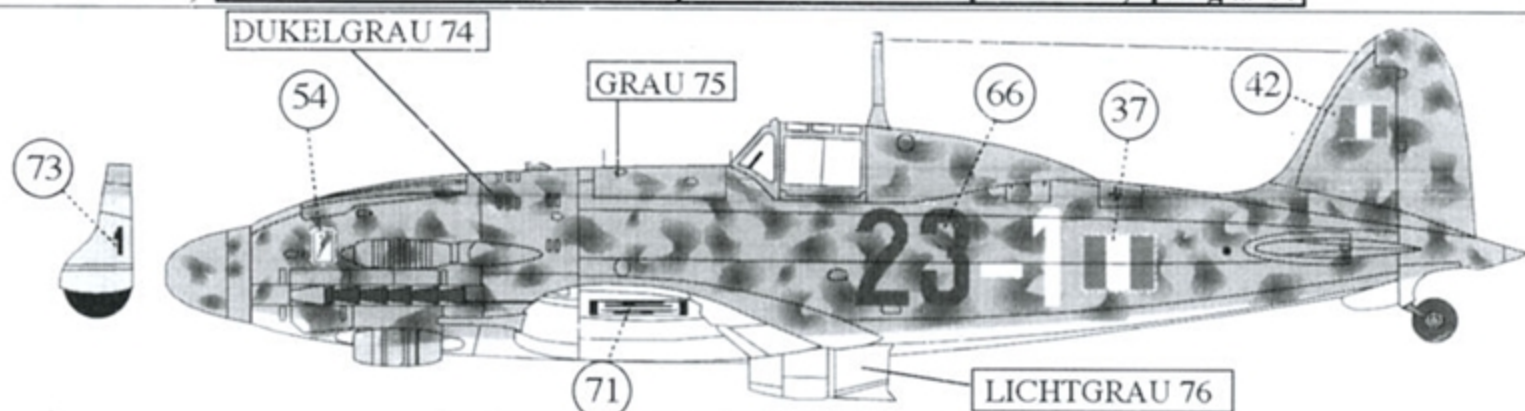

**MACCHI C205V serie III, 1<sup>a</sup>Sq.1<sup>o</sup>Gr.C.T. ANR**

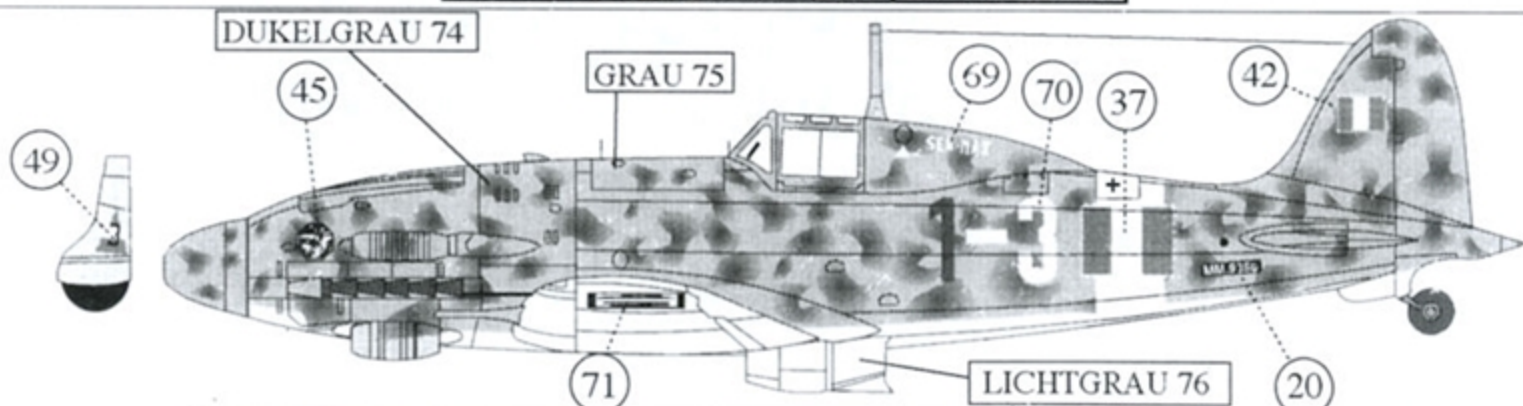

**MACCHI C205V serie III MM.9350- 3<sup>a</sup>Sq.1<sup>o</sup>Gr.CT. ANR.Campodiformio, Spring 1944**

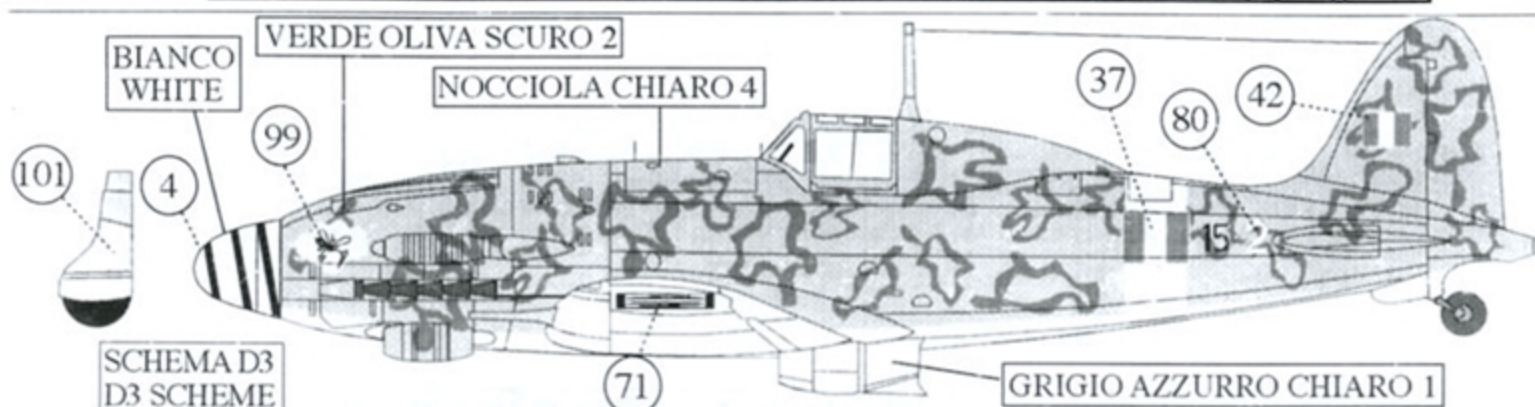

**MACCHI C 205V serie III, 2<sup>a</sup>Sq.1<sup>o</sup>Gr.C.T.ANR, Campodiformio, January 1944**

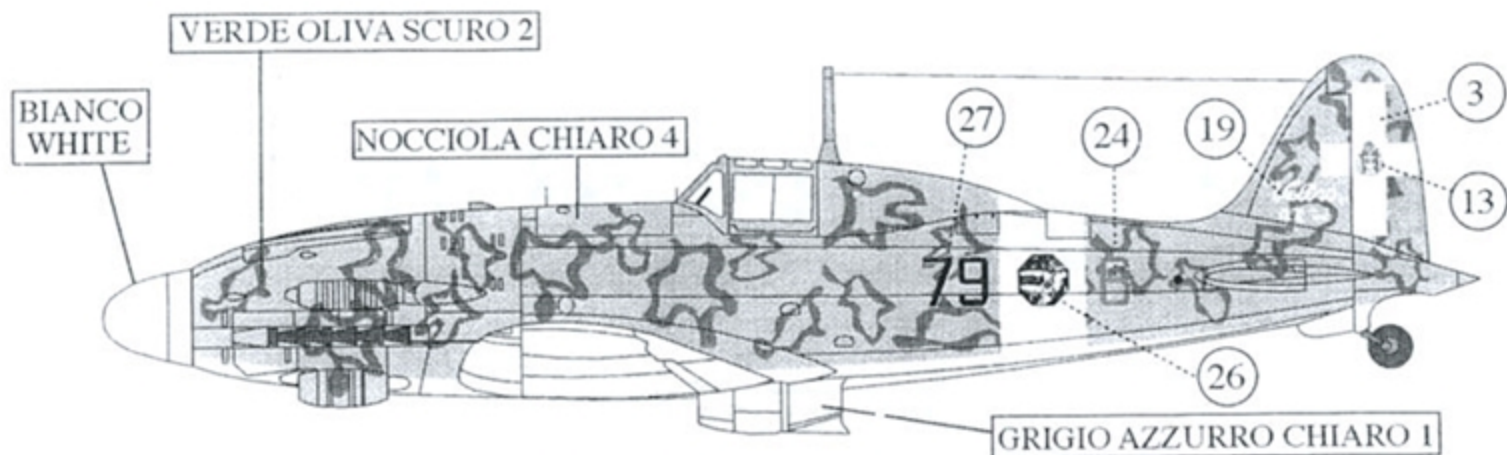

MACCHI MC 205 - 79<sup>a</sup>Sq. 1<sup>o</sup> St. Caccia

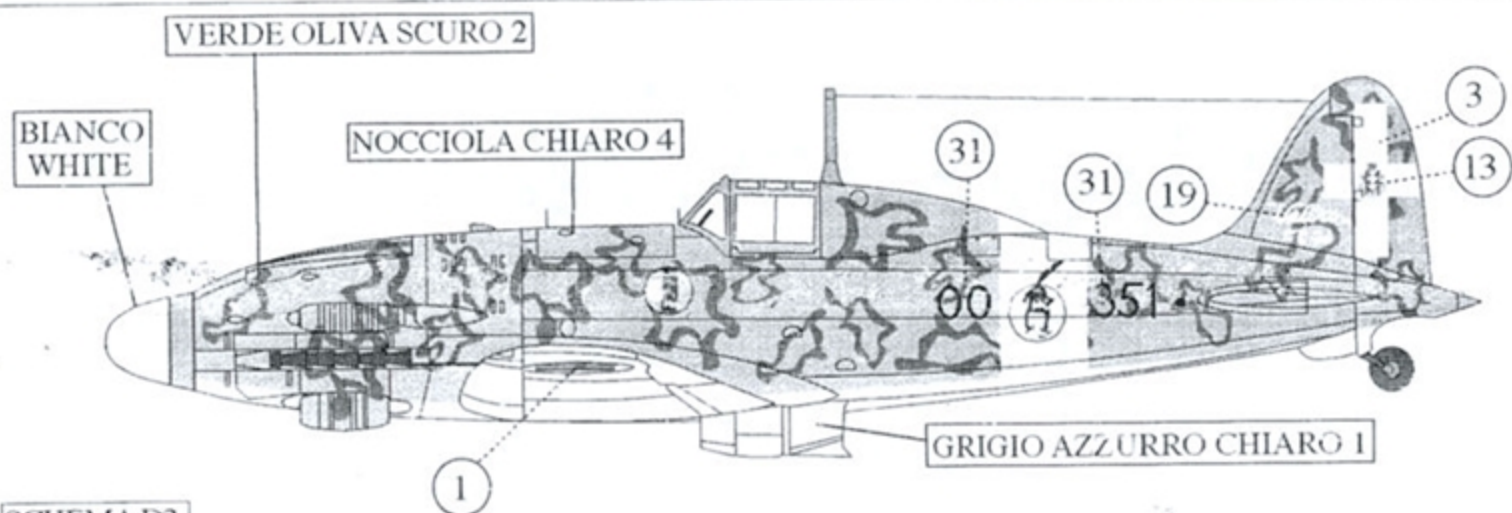

SCHEMA D3  
D3 SCHEME

MACCHI MC 205 FOTOGRAFICO- 351<sup>a</sup>Sq.

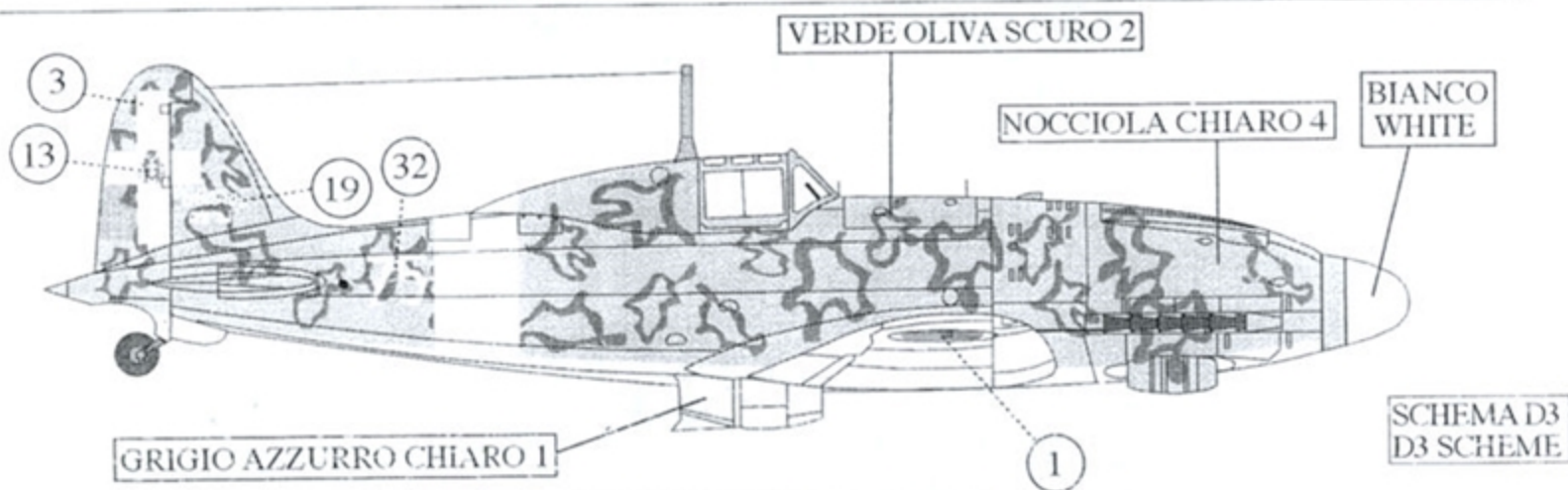

SCHEMA D3  
D3 SCHEME

MACCHI MC 205 - 75<sup>a</sup>Sq.

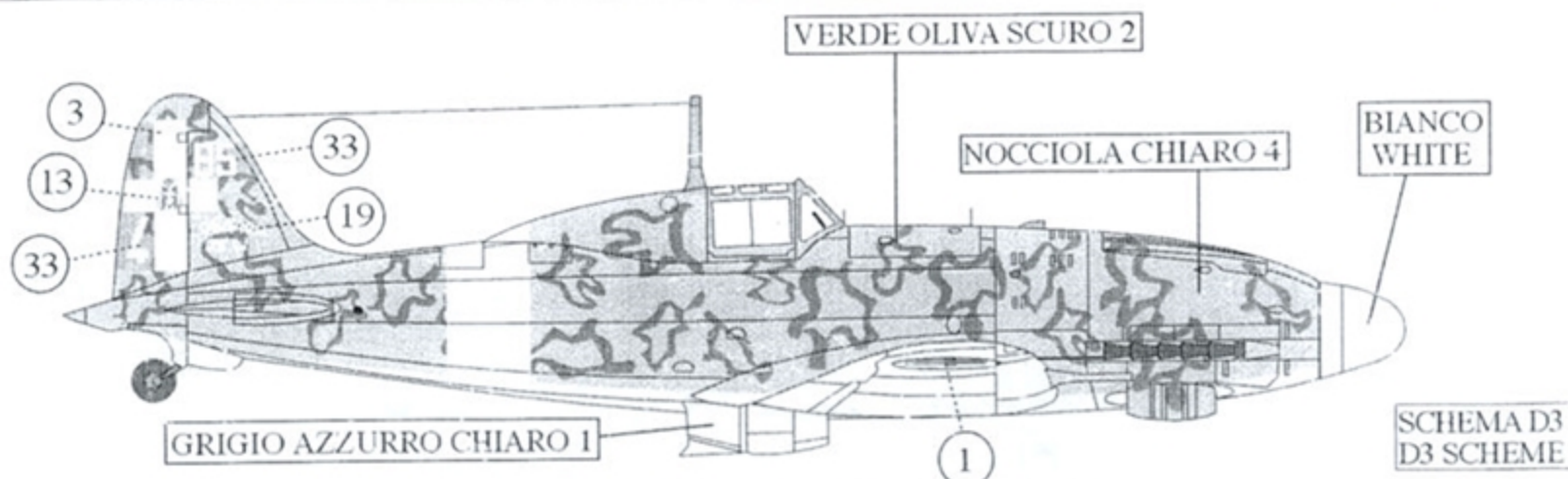

SCHEMA D3  
D3 SCHEME

Macchi MC 205 - 85<sup>a</sup>Sq. 18<sup>o</sup>Gr. 3<sup>o</sup>Sl. 1943



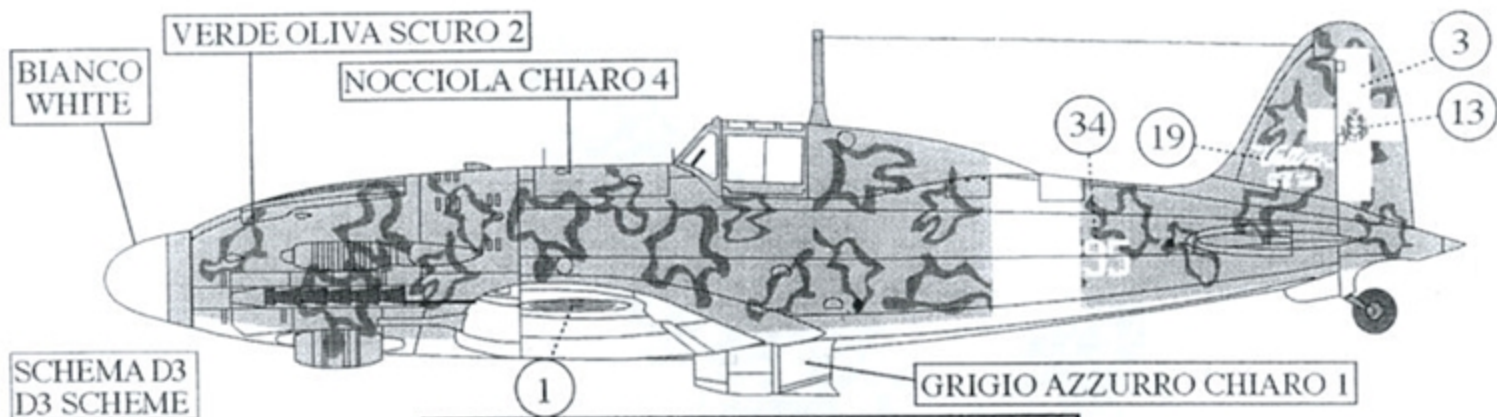

**MACCHI MC 205 - 95<sup>a</sup>Sq. 18° Gr. 3° St. 1943**

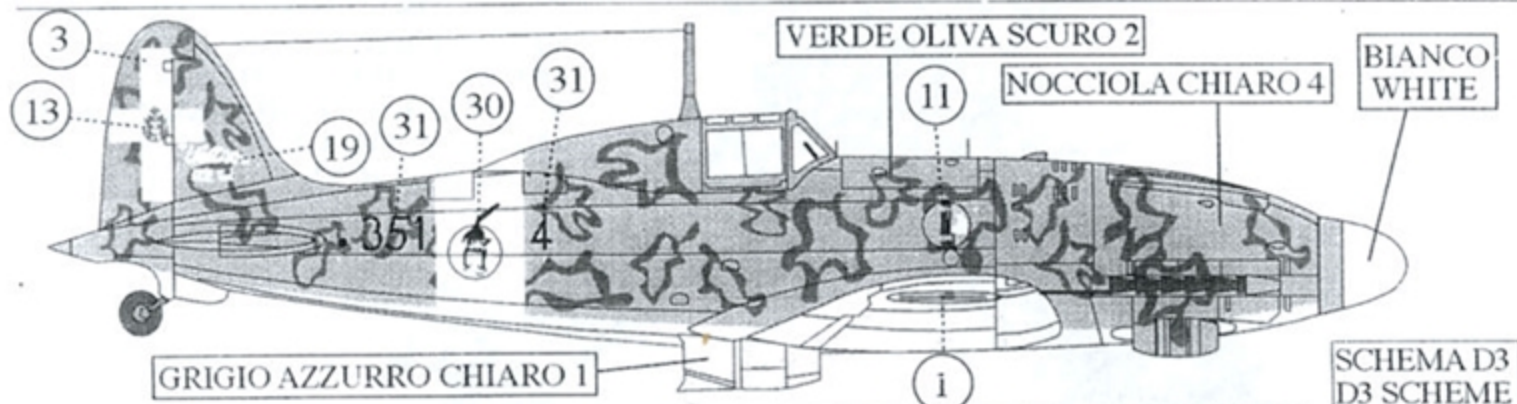

**MACCHI MC 205 - 351<sup>a</sup>Sq. 51° St. - Sardinia, summer 1943**

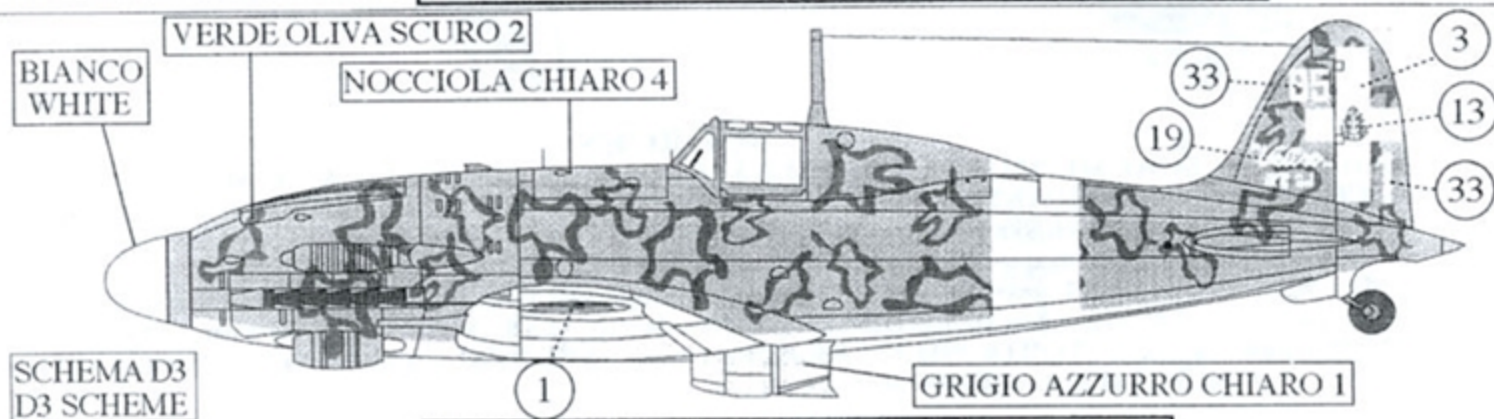

**Macchi MC 205V - 85<sup>a</sup>Sq. 18°Gr. 3° St. summer 1943**

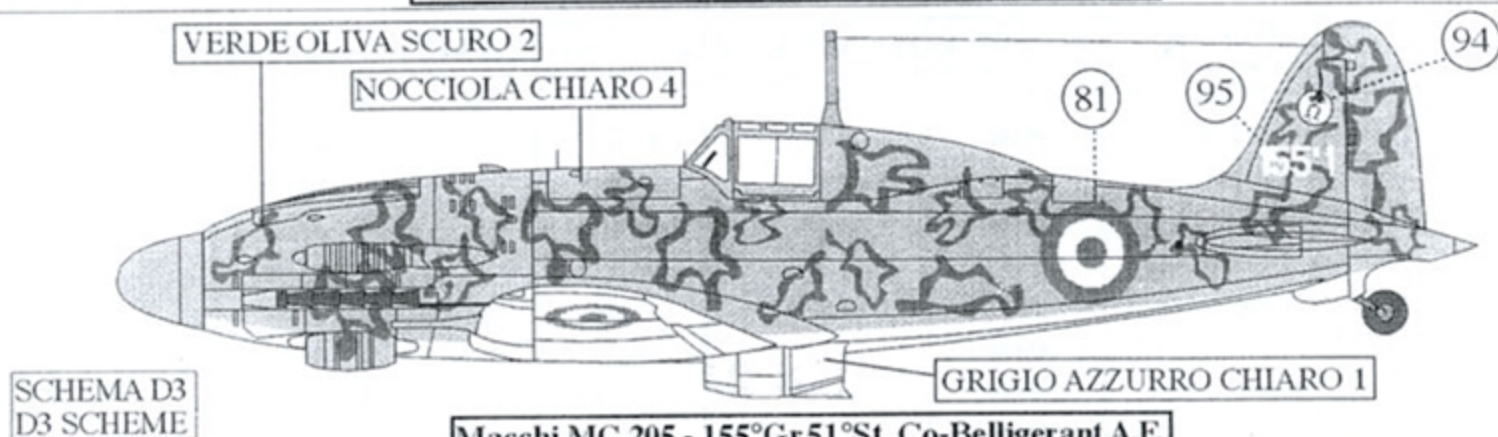

**Macchi MC 205 - 155°Gr.51°St. Co-Belligerent A.F.**

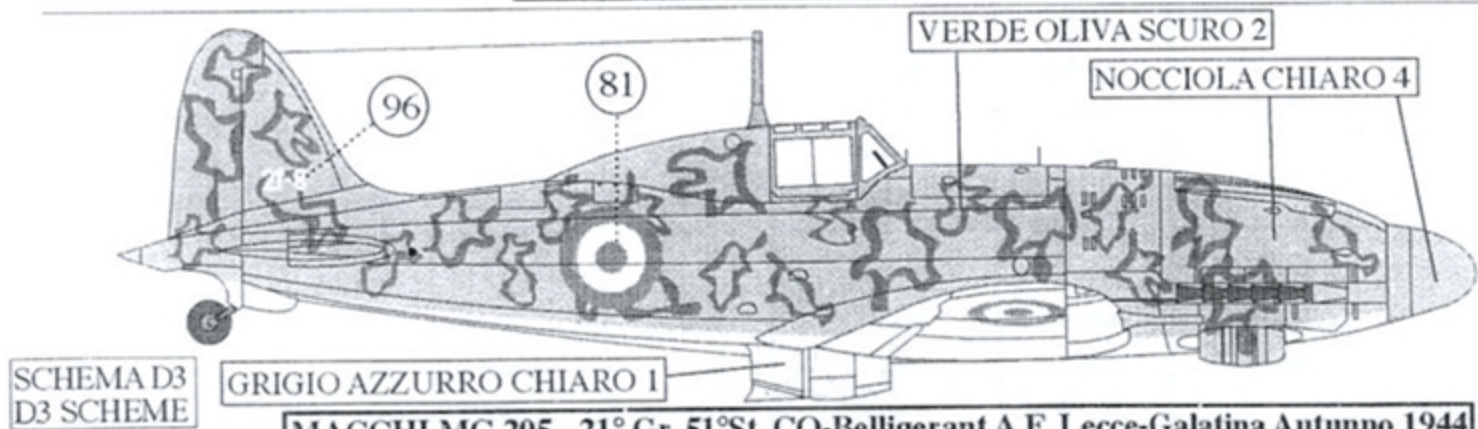

**MACCHI MC 205 - 21° Gr. 51°St. CO-Belligerent A.F. Lecce-Galatina Autunno 1944**

SCHEMA D3  
D3 SCHEME

BIANCO  
WHITE

VERDE OLIVA SCURO 2

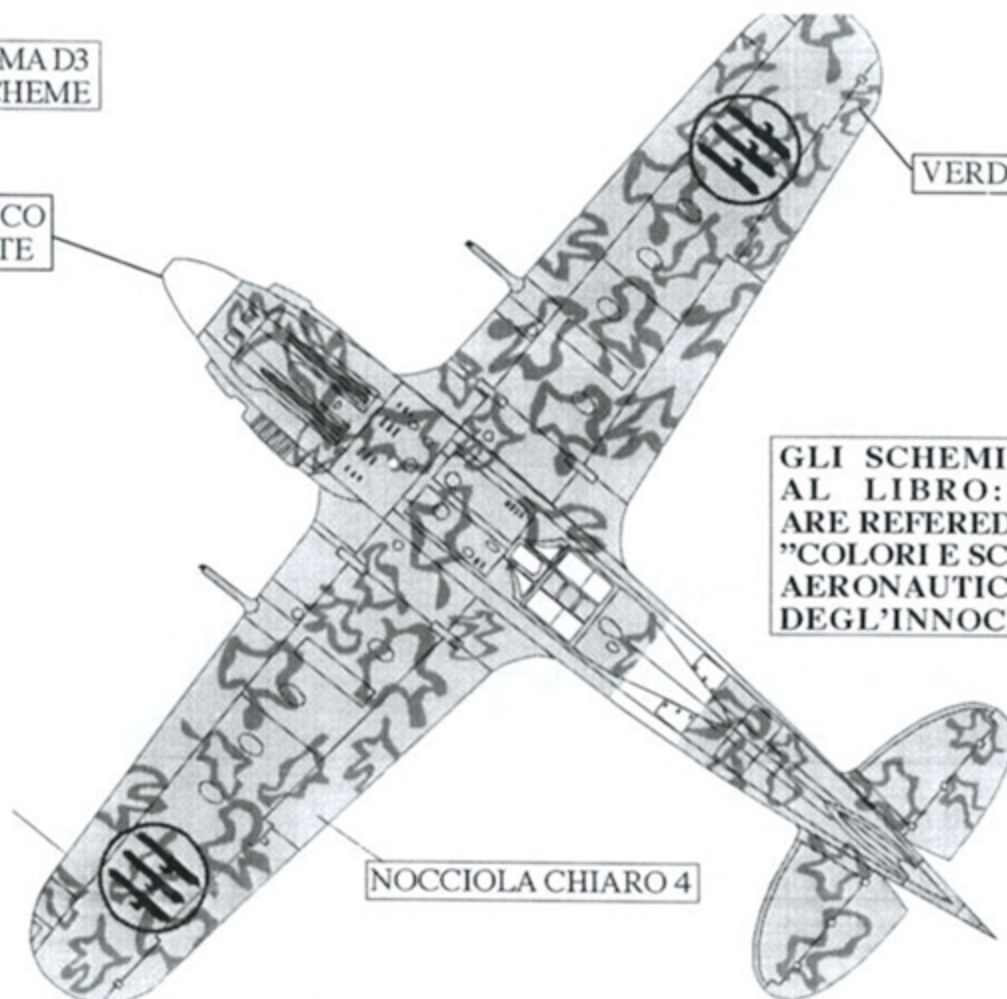

GLI SCHEMI MIMETICI SONO RIFERITI  
AL LIBRO: CAMOUFLAGE SCHEMES  
ARE REFERED AT THE BOOK:  
"COLORI E SCHEMI MIMETICI DELLA REGIA  
AERONAUTICA 1939-1943 DI POSTIGLIONI &  
DEGL'INNOCENTI DEL GMT.CMPR.GAVS.

### SOURCES

COLORI E SCHEMI MIMETICI DELLA REGIA AERONAUTICA, C.M.P.R., G.A.V.S., G.M.T.;  
- SCHEMI E COLORI MIMETICI DELL'AERONAUTICA MILITARE ITALIANA, serie le macchine e la storia n° 4,  
di N.Arena & G.Pini, Stem mucchi editore; L'AERONAUTICA NAZIONALE REPUBBLICANA,  
di N.Arena, Ermanno Albertelli editore; - DIMENSIONE CIELO N° , caccia assalto; - REGIA AERONAUTICA:  
voll; colori e insegne; il settore mediterraneo, di Emiliani, ghergo & Vigna, Intergest editore, 1975-1976;  
- COURAGE ALONE, C.Dunning, Hikoki publications; - AIR WAR ITALY, Beale, d'Amico & valentini,  
Airlife publications; - STORIA MILITARE, numeri vari; - AEROFAN, numeri vari; - STORIA MODELLISMO,  
numeri vari; - AEREI MODELLISMO, numeri vari.

### COLOUR GUIDE

COLOUR	FS 595 B	HUMBROL	MOLAK	TAMIYA	GUNZE	MODEL M	MRKIT
MARRONE MIMETICO 1	30118	142 F	11M	XF 52	22 SG	1702	012
MARRONE MIMETICO 2	30109	+ 180 F	13 M		81 G	+1785	014
MARRONE 53193	30140	+119	30140		+43 G		013
BRUNO MIMETICO	30227	+187 F	+30219 F		+310	+1567 F	015
GIALLO MIMETICO 1	33594	+7 G	LMU 25 F		+44 G		008
GIALLO MIMETICO 2	33481	81 F	33481	+XF 54	27 SG	+1584	009
GIALLO MIMETICO 3	33434		33434		+95 G		010
GIALLO MIMETICO 4	30266	+94 F	+LB12 F		21 SG		011
VERDE MIMETICO 1	34258		34258				004
VERDE MIMETICO 2	34092	S 149 F	34092	+XF 11	302 SG	1764 F	005
VERDE MIMETICO 3	34102	86 F	34102	+XF 58	303 SG	1713 F	006
VERDE MIM.53192	34227	+120 F	34227		312SG	1716 F	007
GRIGIO MIMETICO	36231	140 F	36231 F		317 SG	1740 F	021
GRIGIO AZZ.CHIARO 1	36307	141 F	36307	+XF 19	+334 SG	1726 F	020
VERDE OLIVASC.2	34052		+LJ 1 F	XF 52 F	18 SG		003
GRIGIO AZZ.SC.3	36118	125 SG	36118		305 SG	1723 F	019
NOCCIOLA CHIARO 4	30219	118 F	30219 F		310 SG	1742 F	016
GIALLO CROMO 7	33655	69 G	6 G	X 8 G	+4 G		
ROSSO 8	31105	+ 19 G	+4 G	X 7 G	3 G	+ 1503 G	017