

F-22A

PART 1

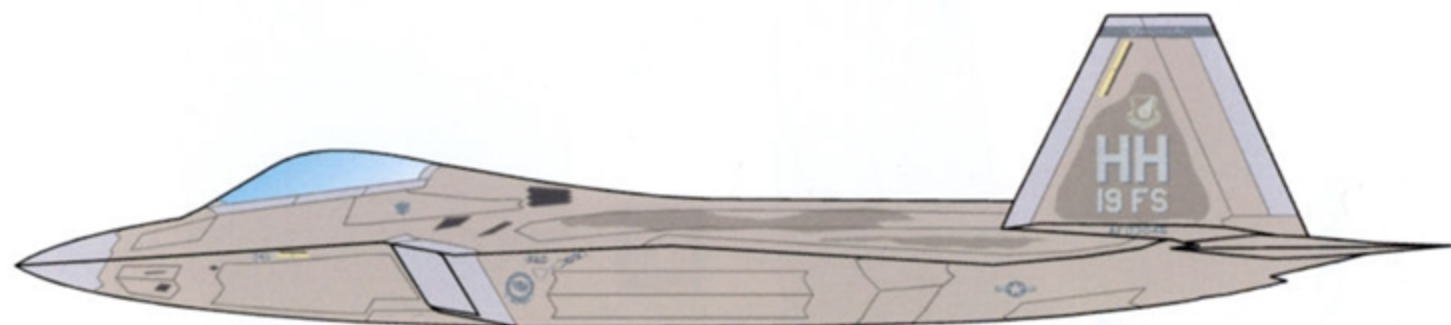
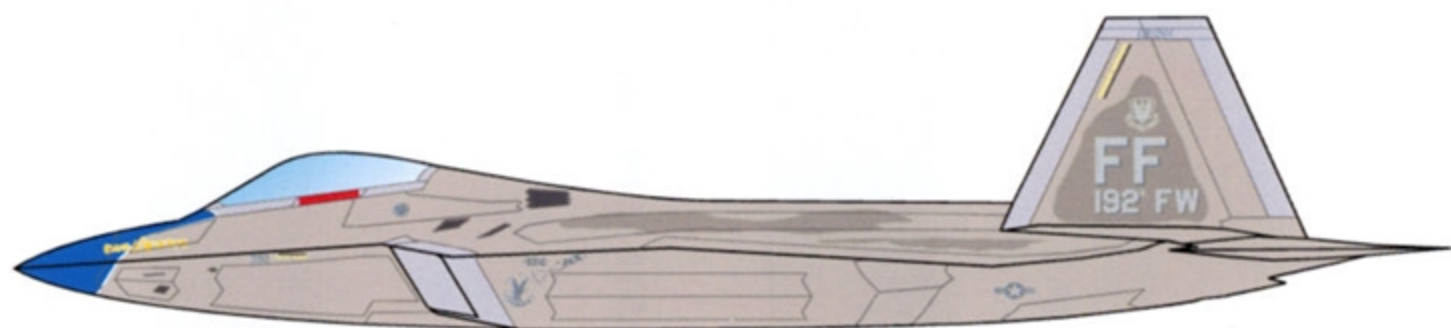
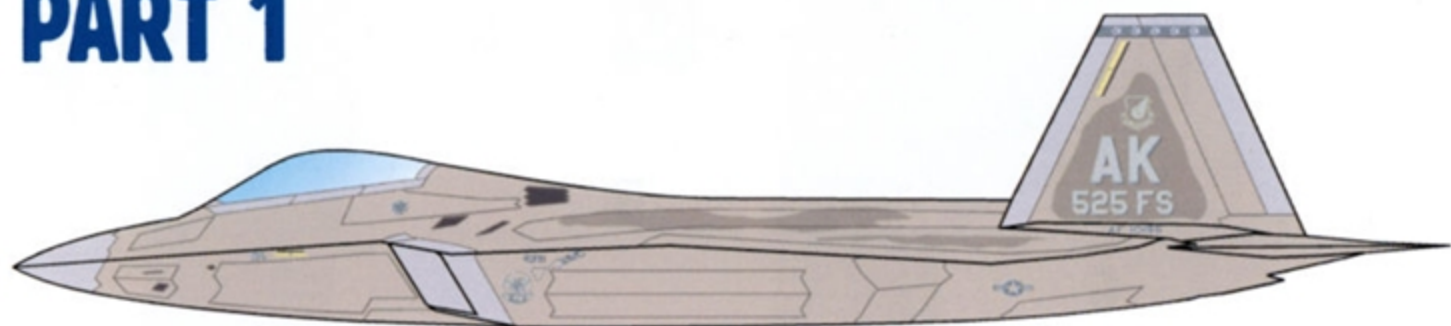

**14 MARKING OPTIONS
DESIGNED FOR THE HASEGAWA KIT**

1/48 SCALE

DECALS PRINTED BY



COMMON MARKINGS & STENCILLING

SOME MARKINGS SHOWN IN BLACK FOR CLARITY

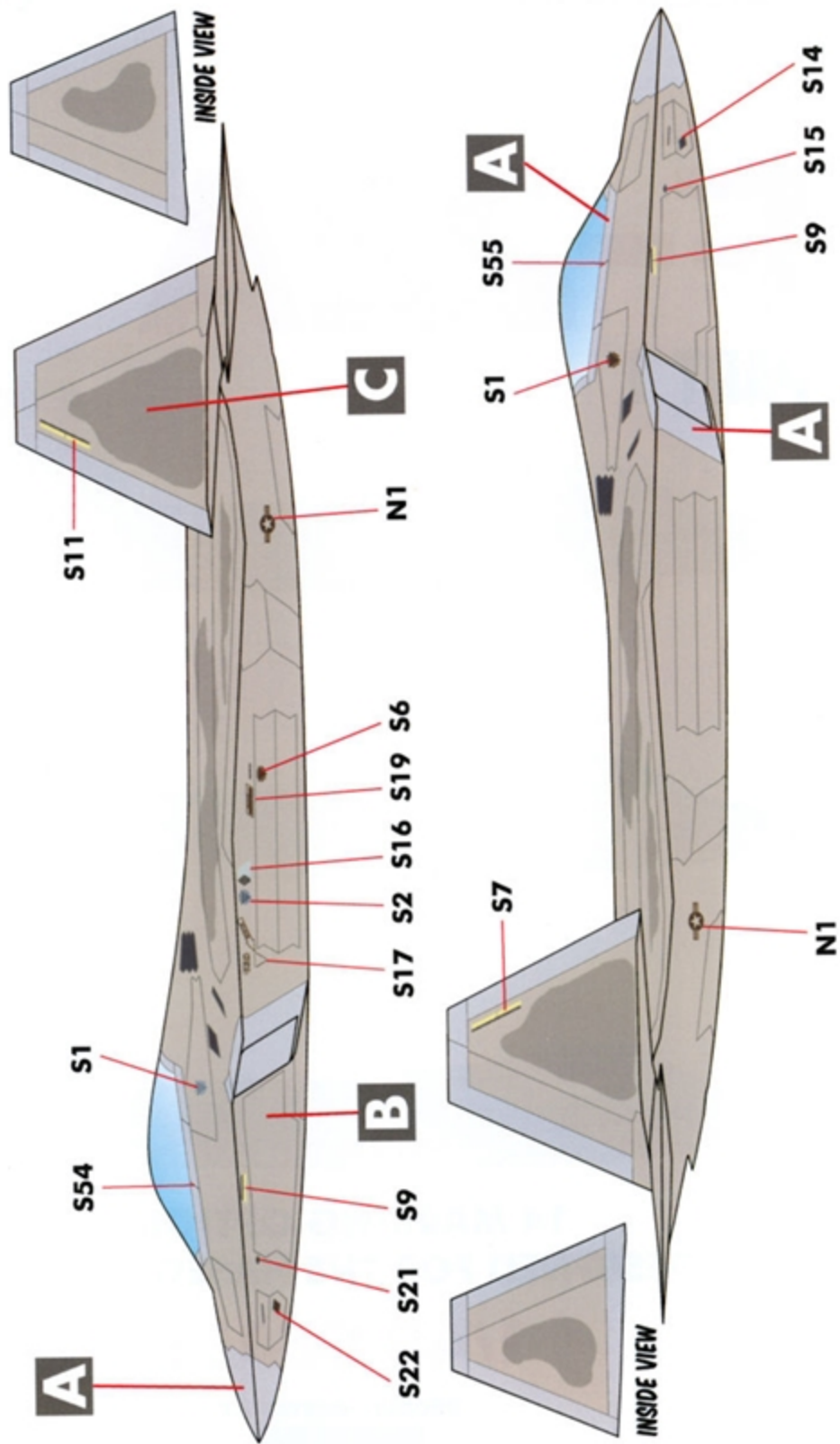

OPTION 1: F-22A RAPTOR 10-4193
3WG, ELMENDORF AFB

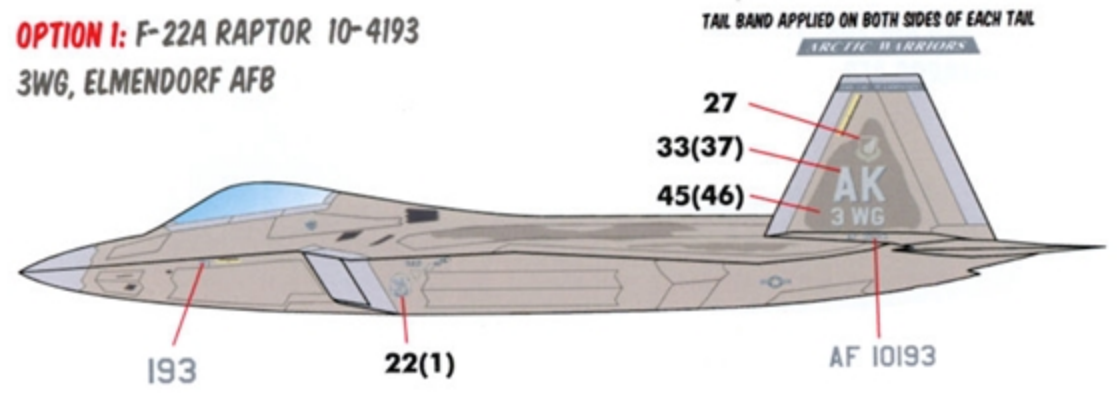

OPTION 2: F-22A RAPTOR 10-4195
525FS, ELMENDORF AFB

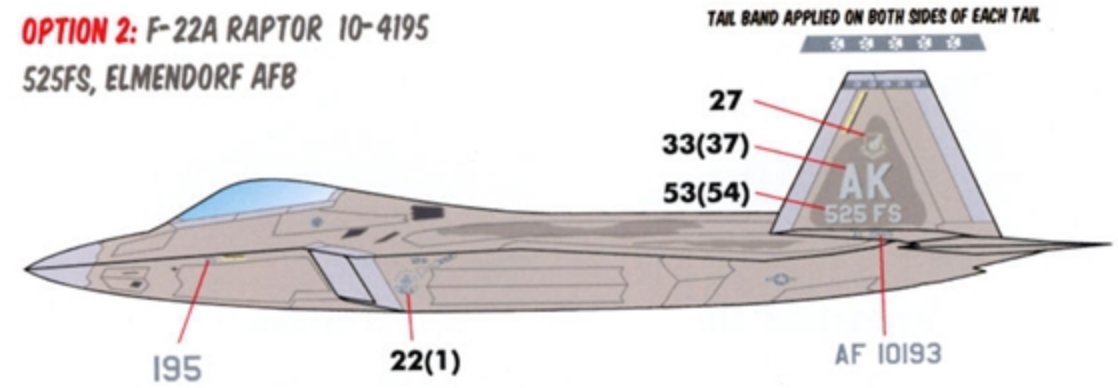

OPTION 3: F-22A RAPTOR 06-4115
525FS, ELMENDORF AFB

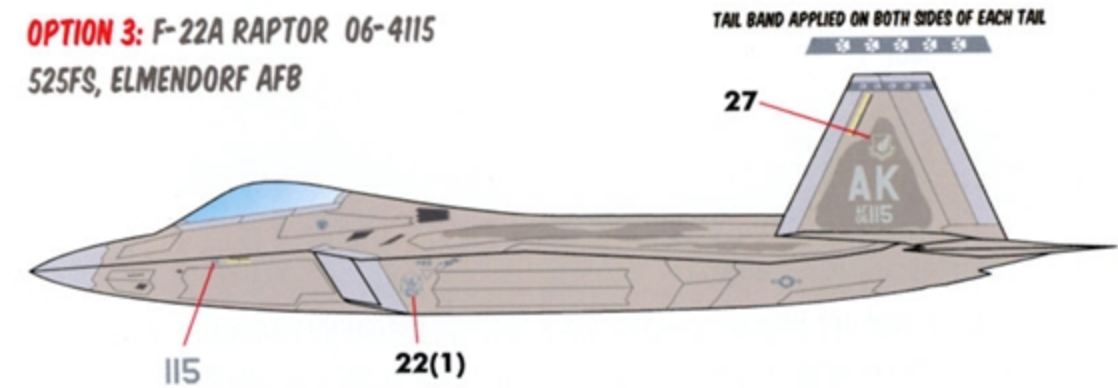

OPTION 4: F-22A RAPTOR 06-4132
411 FLTS, EDWARDS AFB

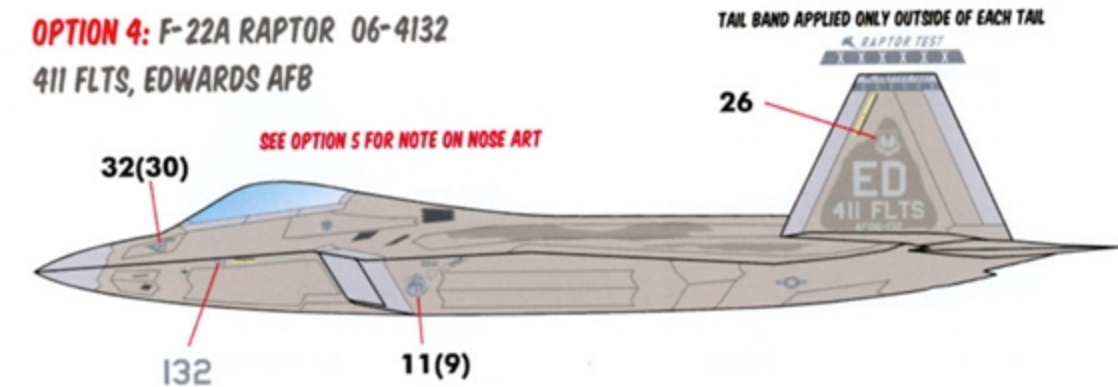

OPTION 5: F-22A RAPTOR 91-4009
411 FLTS, EDWARDS AFB

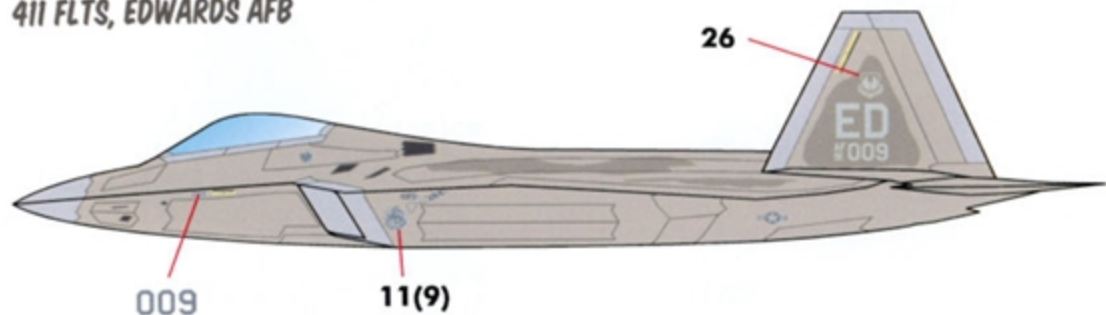

OPTIONS 4 AND 5 ARE AMONG THE F-22 COMBINED TEST FORCE (CTF) JETS THAT CARRY NOSE ART ON THE PORT SIDE.

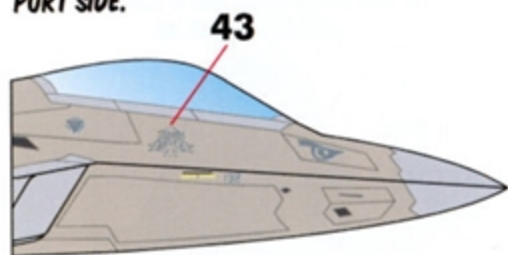

OPTION 4 - "ACE TREY DEUCE" (132)

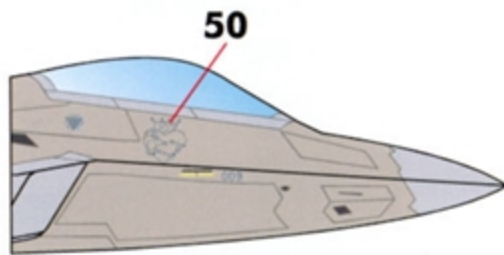

OPTION 5 - "IX" (009)

OPTION 6: F-22A RAPTOR 04-4082 "CRIPES A'MIGHTY" TAIL BAND APPLIED ON BOTH SIDES OF EACH TAIL
192FW, LANGLEY AFB

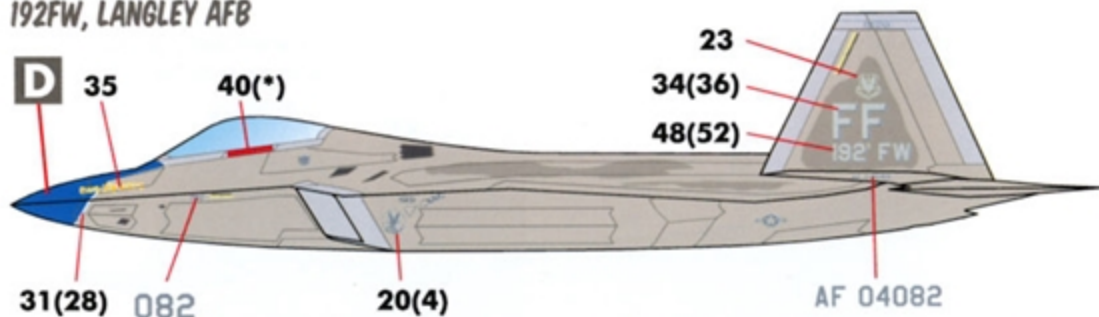

IT IS LIKELY THAT THIS JET WAS DECORATED ONLY FOR PHOTOGRAPHY PURPOSES AND NEVER FLEW IN THIS SCHEME. PLEASE E-MAIL US IF YOU HAVE MORE INFORMATION.

OPTION 7: F-22A RAPTOR 05-4094
94FS, LANGLEY AFB

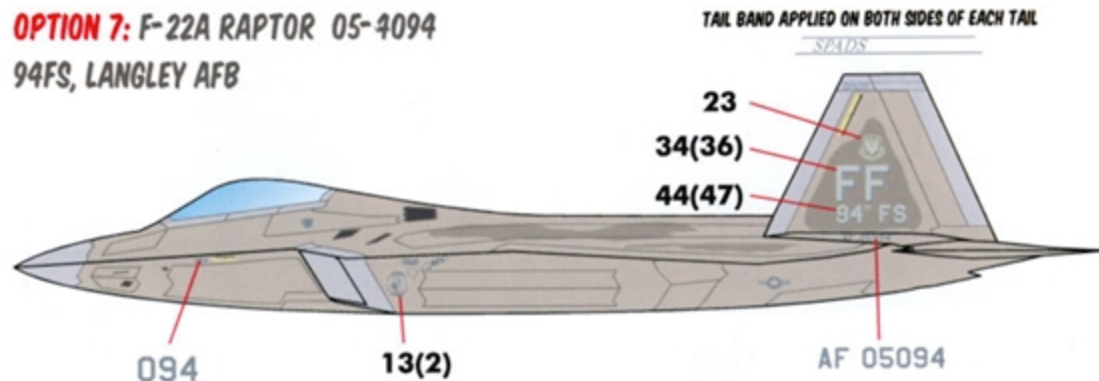

OPTION 8: F-22A RAPTOR 05-4085
94FS, LANGLEY AFB

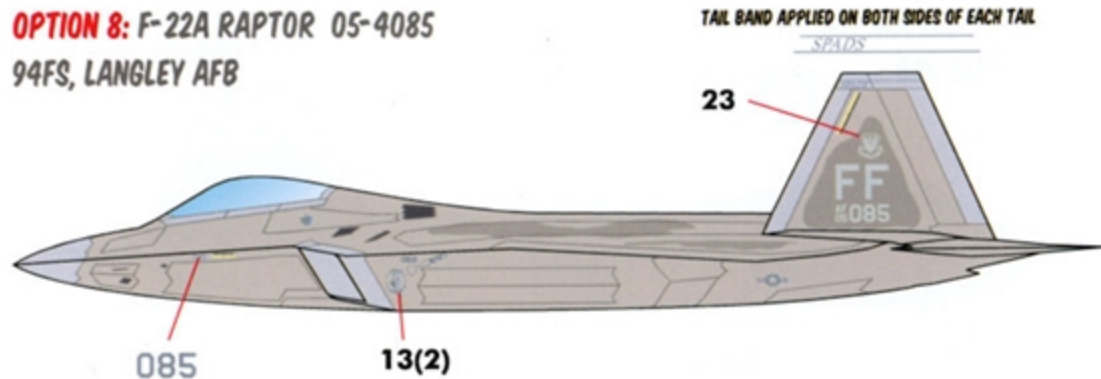

OPTION 9: F-22A RAPTOR 03-4046
19FS, HICKAM AFB

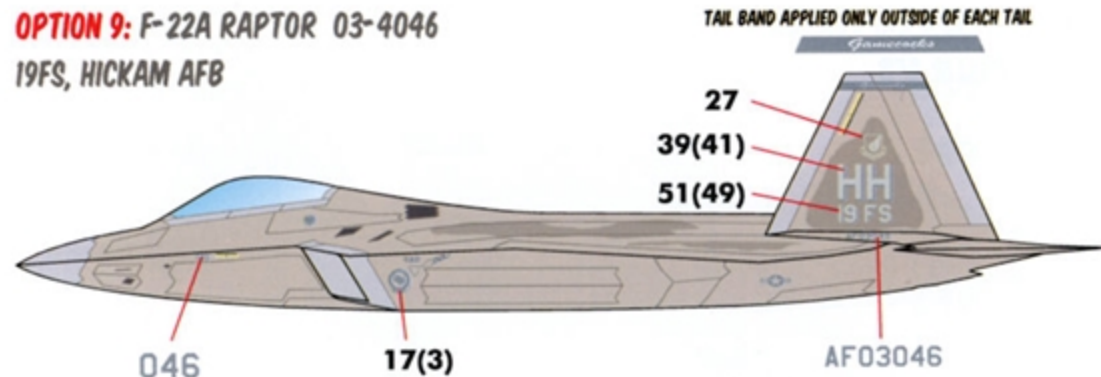

OPTION 10: F-22A RAPTOR 03-4052
19FS, HICKAM AFB

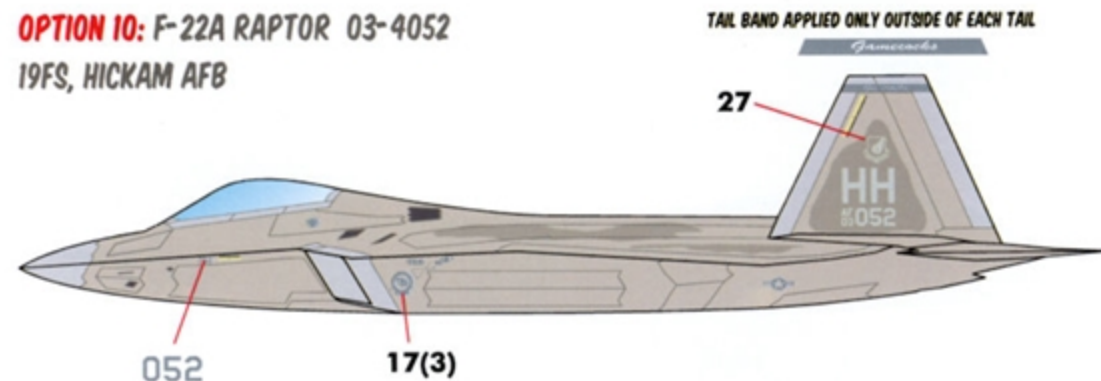

OPTION 11: F-22A RAPTOR 04-4072
8FS, HOLLOMAN AFB

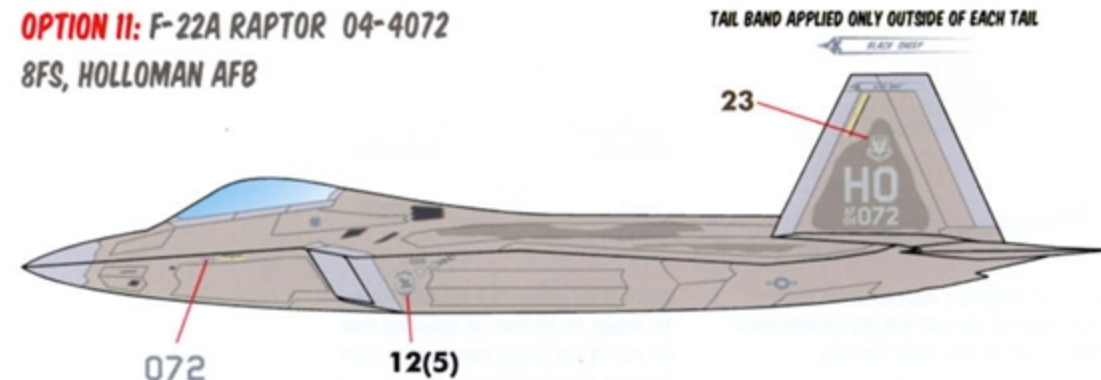

OPTION 12: F-22A RAPTOR 01-4022
43FS, TYNDALL AFB

TAIL BAND APPLIED ON BOTH SIDES OF EACH TAIL

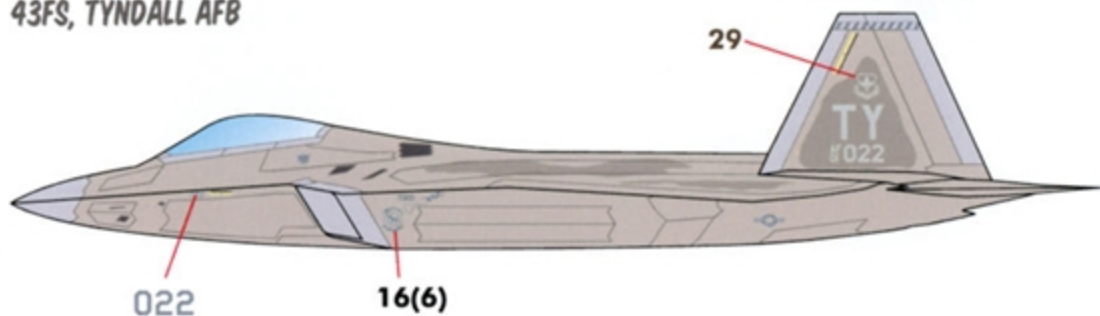

OPTION 13: F-22A RAPTOR 06-4116
433 WPS, NELLIS AFB

TAIL BAND APPLIED ON BOTH SIDES OF EACH TAIL

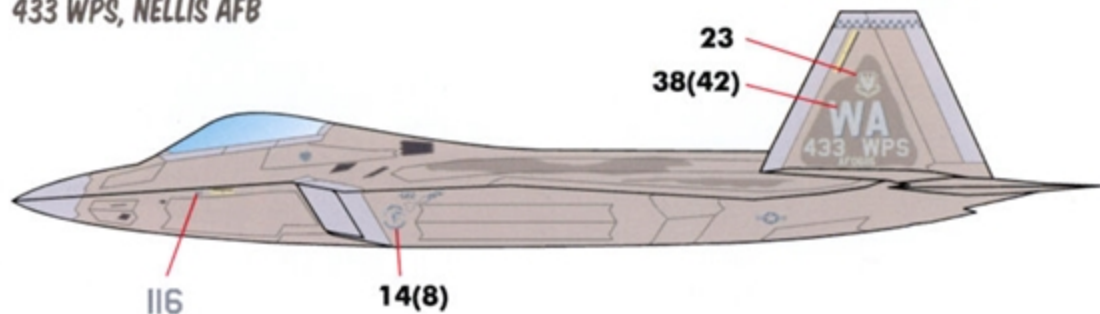

OPTION 14: F-22A RAPTOR 06-4109
433 WPS, NELLIS AFB

TAIL BAND APPLIED ON BOTH SIDES OF EACH TAIL

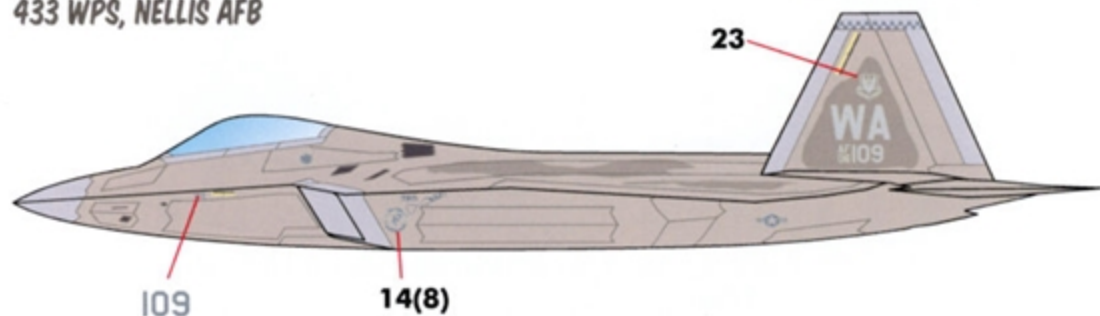

CANOPY DETAILS

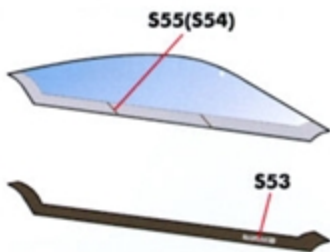

INTAKE COVERS

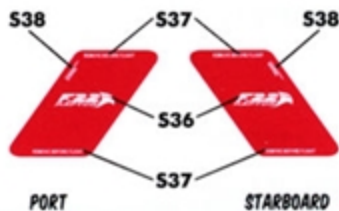

APPLY THIS PROMINENT MARKING ON THE CANOPY INNER FRAME ON THE PORT SIDE. SEE THE REFERENCE PAGE FOR PHOTOS THAT SHOW THE AREA.

MARKINGS FOR STANDARD F-22 INTAKE PLUGS ARE SHOWN. PLEASE VISIT THE REFERENCE PAGE FOR PHOTOS AND INFORMATION ON RESIN PARTS AVAILABLE FROM BAM MODELS.

TOP VIEW

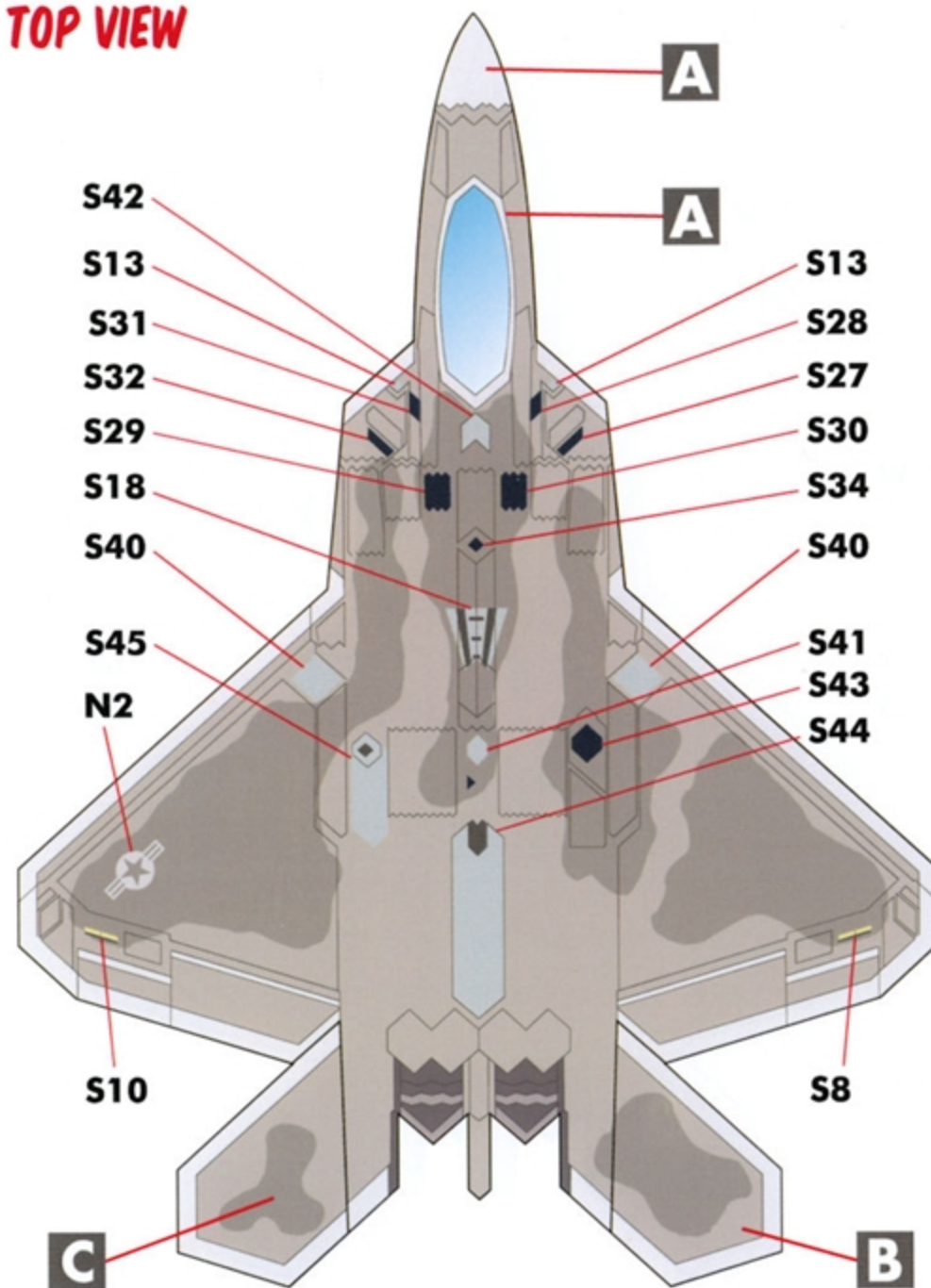

BOTTOM VIEW

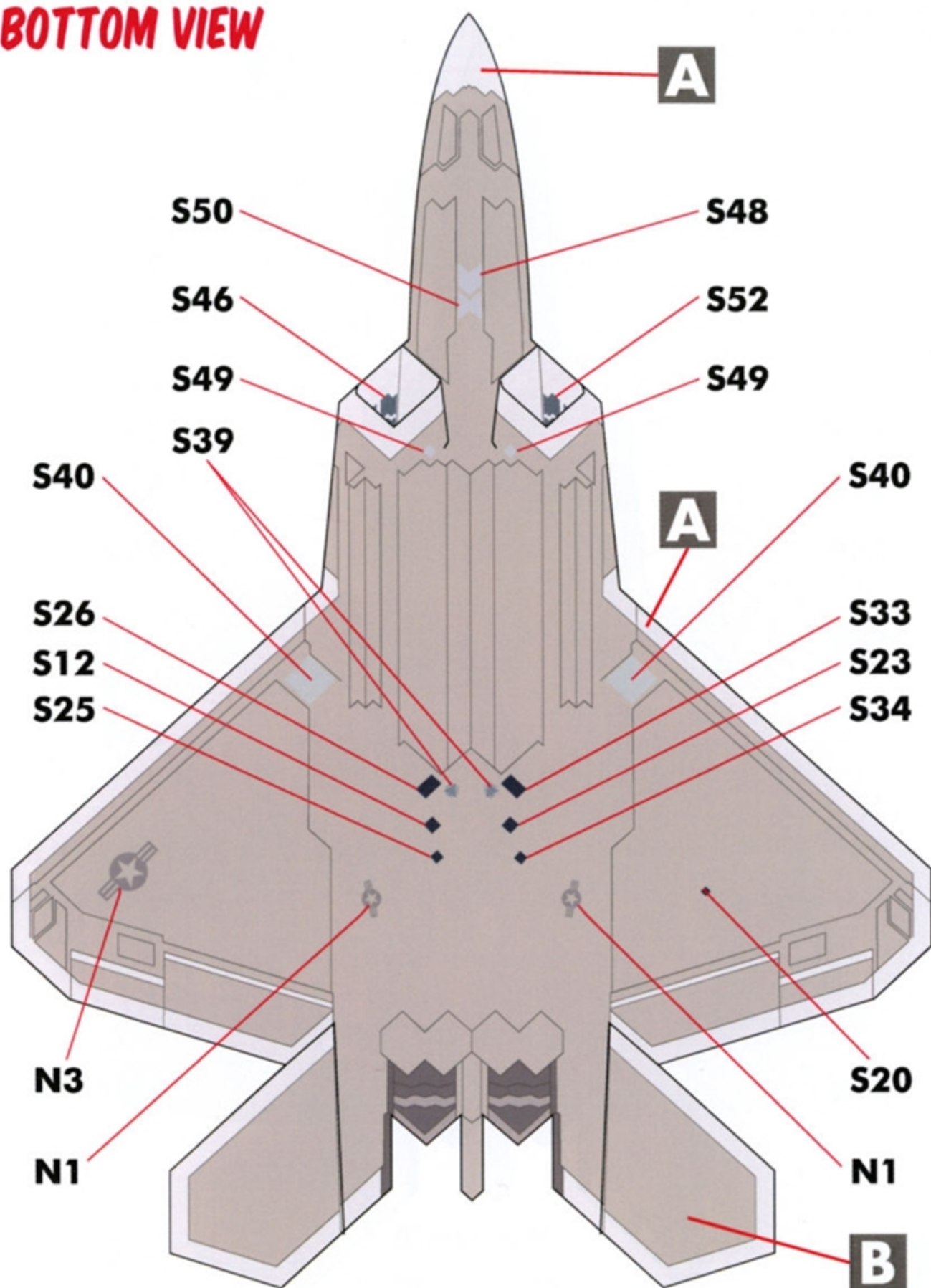

VISIT THE REFERENCE PAGE AT:

[HTTP://WWW.CARACALMODELS.COM/REFERENCES/F22](http://www.caracalmodels.com/references/f22)

- A** LIGHT GHOST GRAY (FS36375)
- B** MOD EAGLE LIGHT GRAY (FS36251)(*)
- C** MOD EAGLE DARK GRAY (FS36176)(*)
- D** FRENCH BLUE (FS15180)

(*) WHILE THESE ARE THE OFFICIAL COLORS, THE F-22 PAINT HAS A METALLIC SHEEN DUE TO ITS RADAR ABSORBENT PROPERTIES.

Caracal Models
PO Box 92141
Austin, TX 78709
info@caracalmodels.com
<http://www.caracalmodels.com>

Decals printed by Cartograf in Italy