

THUNDER CALS™

1/48th Scale P-47D Bubbletop and Razorback Thunderbolts ETO Part 1
84th FS/78th FG/8th Air Force; 336th FS, 387th FS/365th FG/9th Air Force

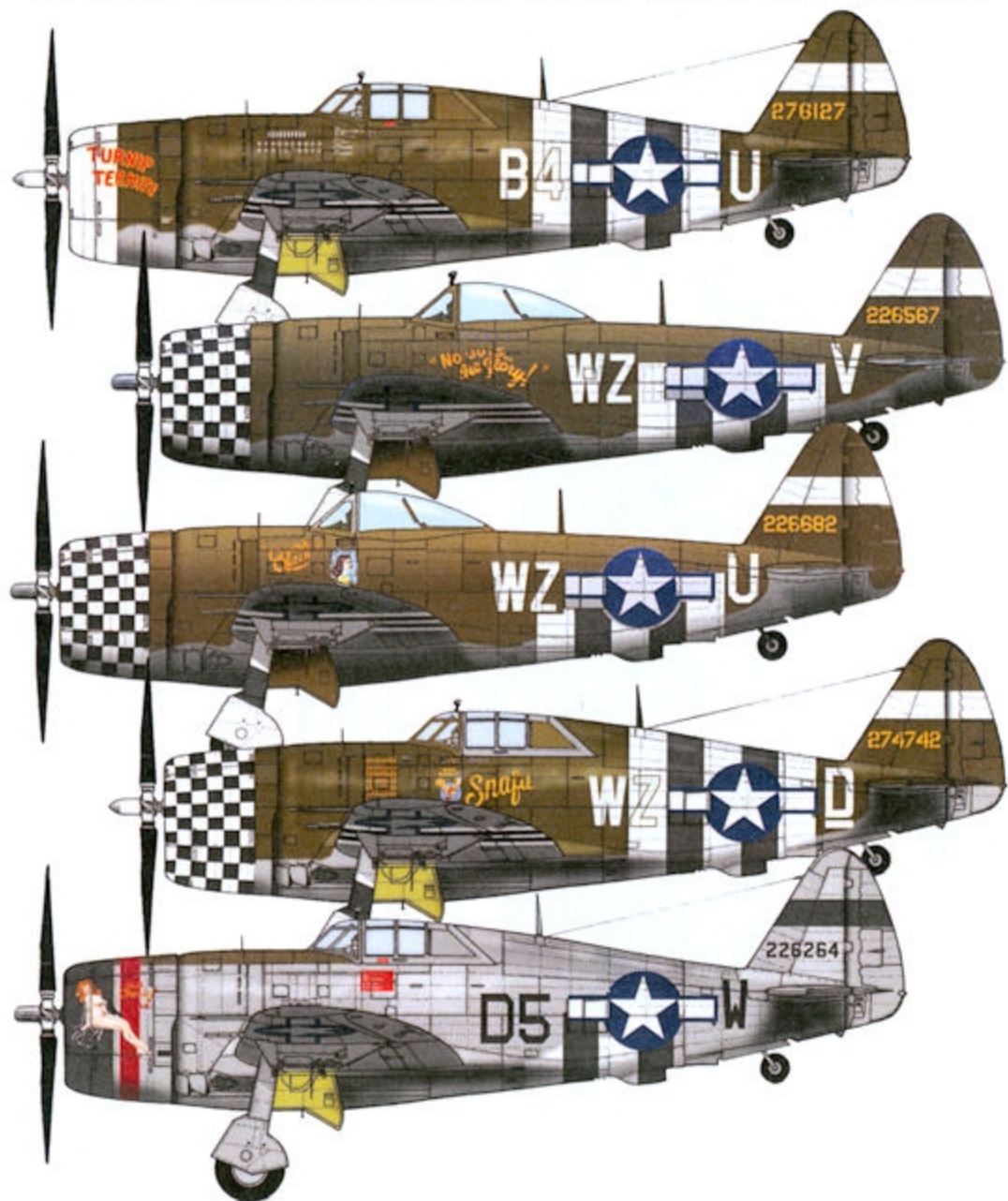

Thundercal decal No. 48-006



Overall scheme: RAF Dark Green over Sky Grey. Sky Grey modern equivalent FS36463. Suggest Tamiya XF-19-mix 1 part to 1 white or Vallejo #154 Sky Grey. Use Type B checkers. Paint cowl white prior to Black checker decal application. Prop: Hamilton Standard Hydromatic Prop hub: NMF. Wing insignia: Top left 40". Wing Underside, both wings 50". Fuselage insignia 35" version 4. Invasion stripes: Underside wings 5x20" (worn and faded), Lower fuselage stripes 5x18". Tail stripes: White 12" vertical and 15" stabs (top and underside). Fuselage version 4 insignia: Paint intercooler door and duct nmf. Paint Invasion stripes. Apply insignia, add NMF outline decal under insignia.



Ozark Queen 84th FS/78th FG, 8th AF P-47D25-RE
Pilot: Capt. Alfred F. Eaton C/C: S/Sgt. John Saviks
Summer 1944

Overall scheme: O.D. over Neutral Gray. Type A checkers (white check on bottom) paint cowl white prior to black checker decal application. Prop: Hamilton Standard Hydromatic Prop hub: NMF. Note that part of windscreen is NMF. Wing insignia: Top left 40". Wing Underside, both wings 50". Fuselage insignia version 4. Invasion stripes: Underside wings 5x20" and well weathered. Lower fuselage 5x18". Tail stripes: White 12" vertical and 15" stabs (top and underside). Fuselage version 4 insignia: Paint intercooler door and duct NMF. Paint Invasion stripes. Apply insignia, add NMF outline decal under insignia.

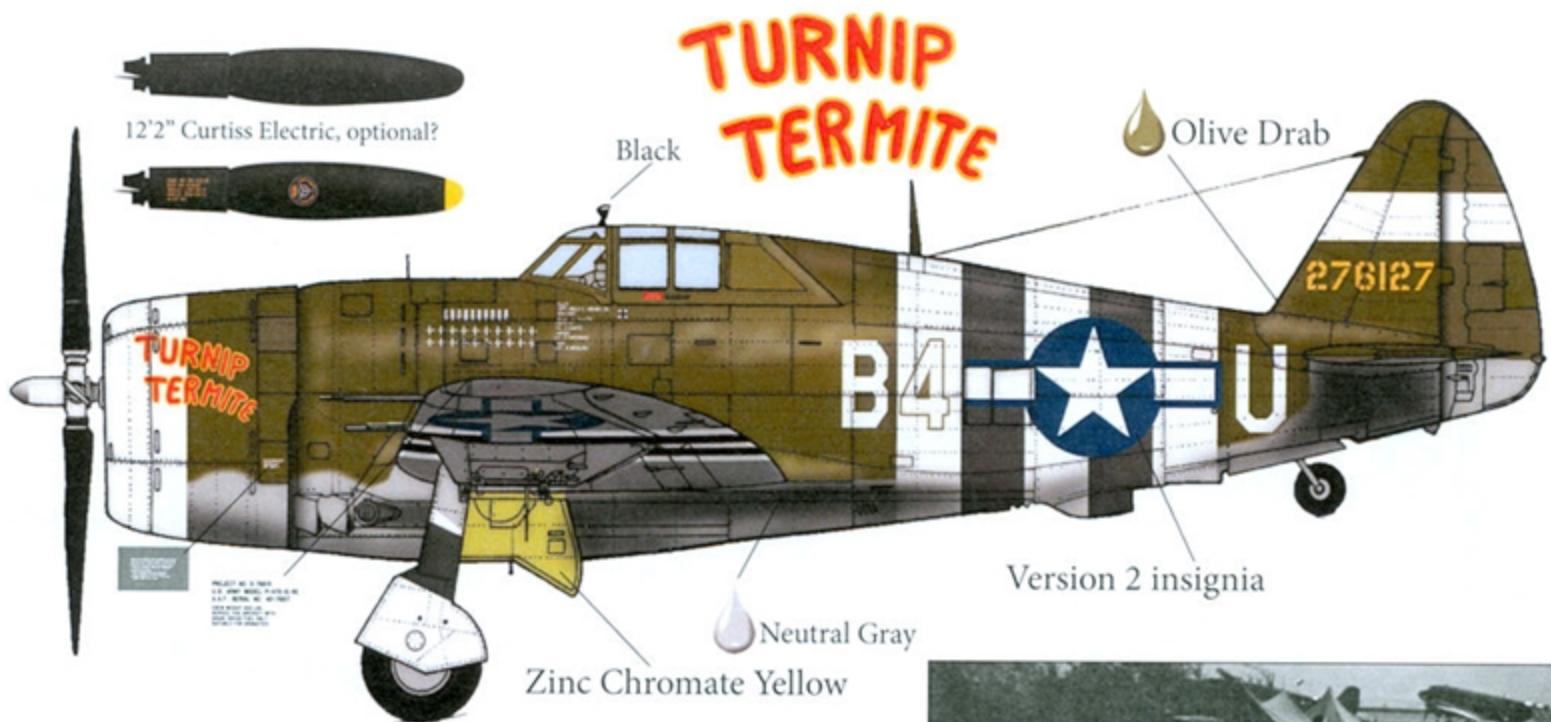

**Turnip Termite, 387th FS/365th FG, 9th AF, P-47D-15-RE
Pilot: Capt. Arlo Henry C/C: S/Sgt. D. White June 7, 1944**

Overall scheme: O.D over Neutral Gray. Prop: 12'2" CE prop thought to be plain; no data, CE logo or yellow wing tips. However, complete data is available in the data section for modeler option. Prop hub: NMF. Windscreen mirror is black. Wing insignia: Top left 40". Wing Underside, both wings 50". Fuselage insignia 35" use Version 2. Full invasion stripes; Wing Invasion stripes: Non Standard 5x18". Note outer wing stripe position in image, fuselage stripes: 5x18". Tail stripes: White 12" vertical and 15" stabs (top and underside.)

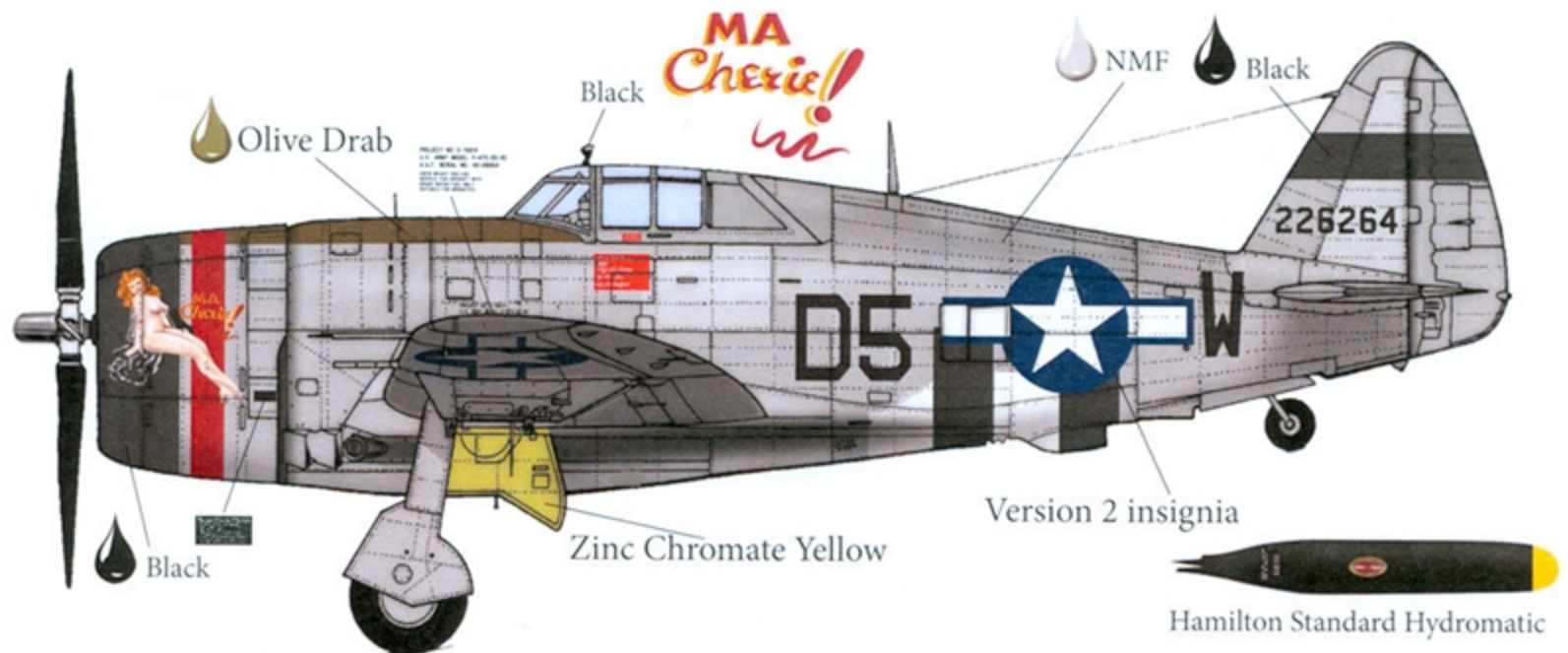

**Ma Cherie 336th, FS/365th FG 9th, AF. P-47D-22-RE
Pilot: 1st LT. Robert Thoman C/C: S/Sgt. O.S. Harney
November - December 1944**

Overall NMF, Black cowl ring and O.D. anti-glare (terminates at black cowl ring) ADD red stripe decal. Black windscreen mirror. Prop: Hamilton Standard Hydromatic. Wing insignia: Top left 40". Wing Underside, both wings 40". Fuselage insignia 35" version 2. Invasion stripes; NO under wing stripes. Fuselage half stripes 3x18" very worn - no aft white stripe at all. Tail stripes: 12" black on vertical, 15" black on stabs. Eventually remaining remnants of invasion stripes removed as well as black tail stripes.



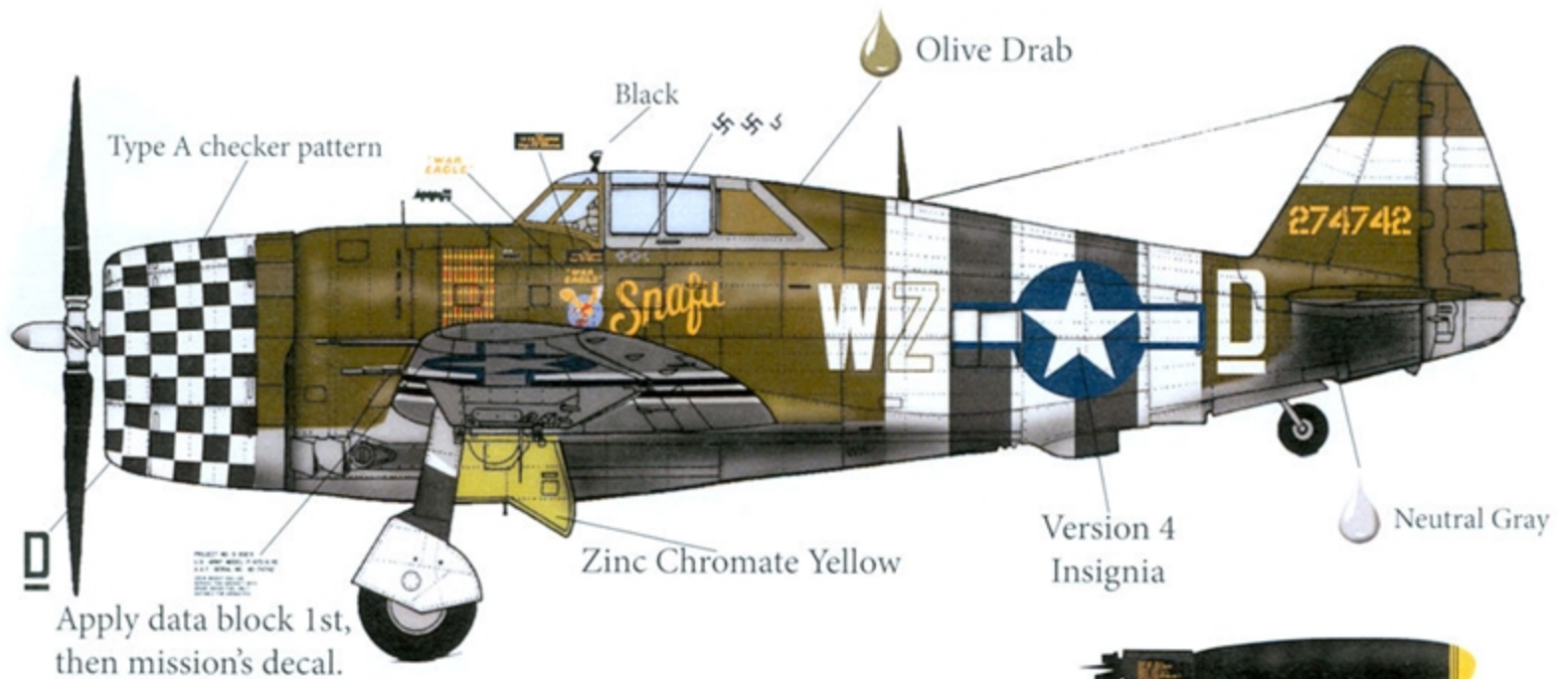

SNAFU 84th FS/78th FG 8th AF. P-47D-6-RE

Pilot: Lt. Severino B. Calderon C/C: T/Sgt. E.E. Draxton

D-Day through Dec 1944

12' 2" AO Smith Asymmetrical

Overall scheme: O.D. over Neutral Gray. Type A checkers (white check on bottom) Paint cowl white prior to Black checker decal application. Prop hub is NMF. Windscreen is O.D. with black mirror. Canopy framing is NMF. Wing insignia: Top left 40". Wing Underside, both wings 50". Fuselage insignia version 4. FULL invasion stripe version; Wing invasion stripes 5x20" Fuselage 5x18" use outlined WZ code (Outlined "W" on right side, Outlined "Z" on left side placed on forward white stripe.) Tail stripes; vertical 12" white and 15" stabs, white. Half stripe version: No under wing invasion stripes. Lower fuselage invasion stripes 5x18" use regular non outlined WZ codes. Tail stripes: White 12" vertical half stripe terminates at the black rudder and full white 15" stabs (top and underside).



Checked cowl instructions

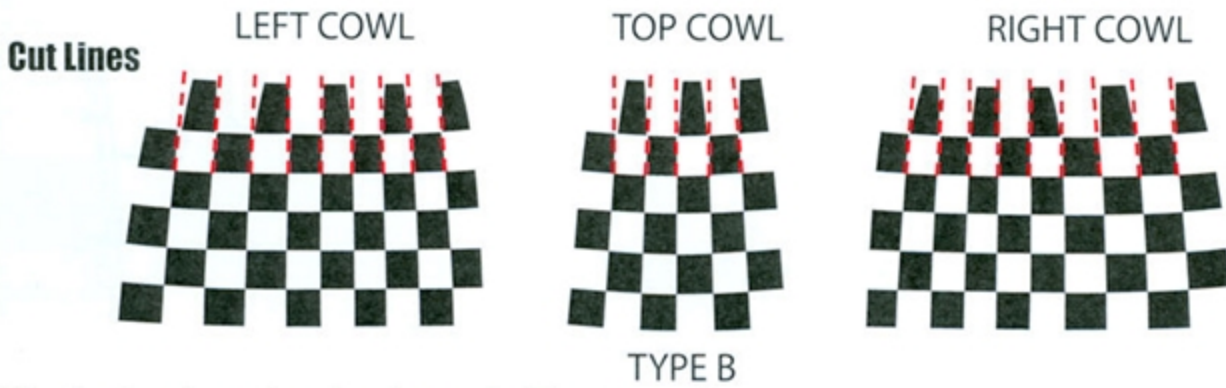

Checks decals are fitted to the to the Tamiya cowling.

Make cuts in decals to the second column of checks. Take care to not trim away edges of black checks.

Apply the top panel decal first. Align the rear column of checks with the back of the cowl. The rows will fit inside the panel lines.

Apply one of the side panel decals. Align the top rear check with the back of the cowl and the top panel decal. The 6th row will fit inside the panel line.

The remaining rows will wrap around to the bottom of the cowl.

Apply the other side panel decal similarly. Align the top rear check with the back of the cowl and the top panel decal. The 6th row will fit inside the panel line. The remaining rows will wrap around to the bottom of the cowl and meet in the center.

For the type B check decals, the front column of checks will wrap around the cowl lip.

For the type A check decals, the front column of checks will end at the panel line on the cowl lip.

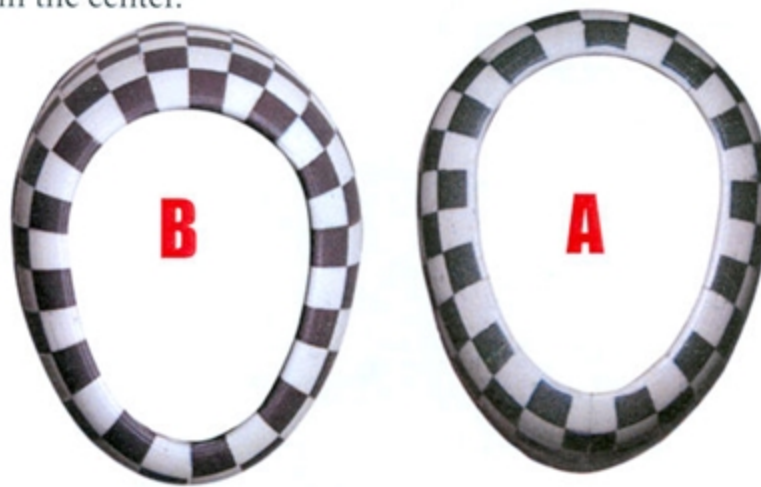

Invasion stripes tip: Remember to mask for the national insignias on both the wings and the fuselage sides so the insignia decals have only one color underneath. Failure to do so can result in the color change beneath showing through the white areas of the national insignias.



Flap Indicator
Left & Right
M M M M M

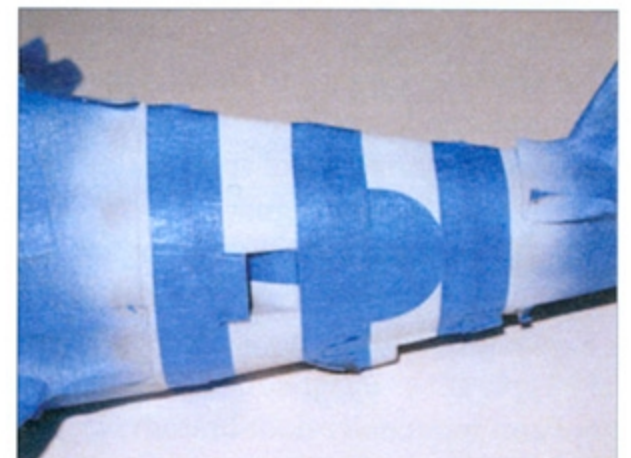
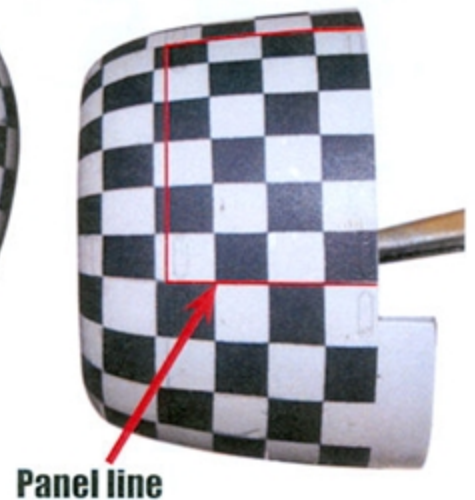
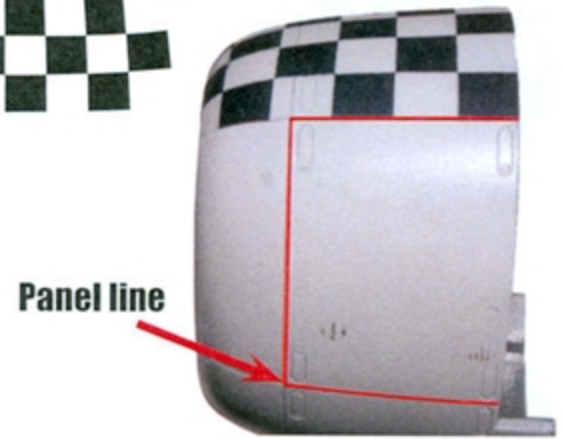

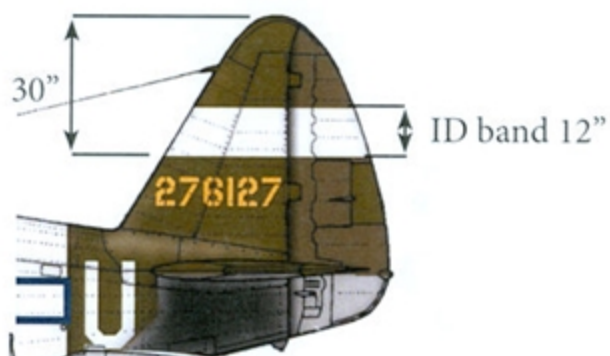

General placement standard 5x20" invasion stripes for 78th FG and 5x18" fuselage invasion stripes I.D. band placement for all a/c. Refer to reference material for variations.

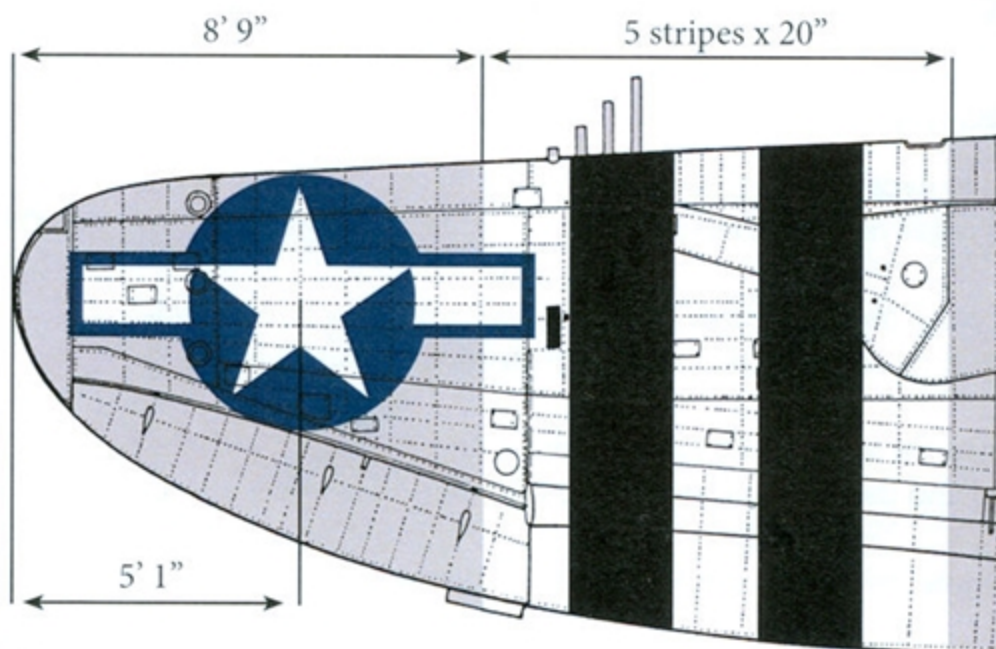

Turnip Termite
5 stripes x 18"

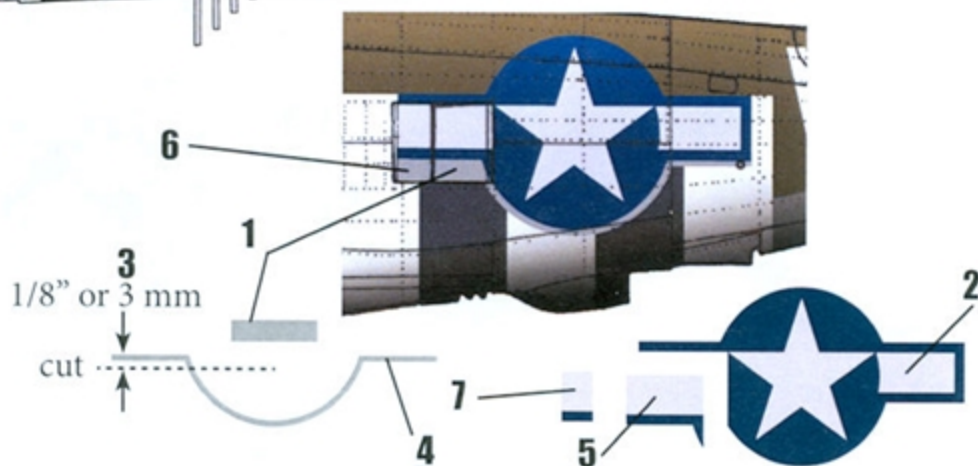
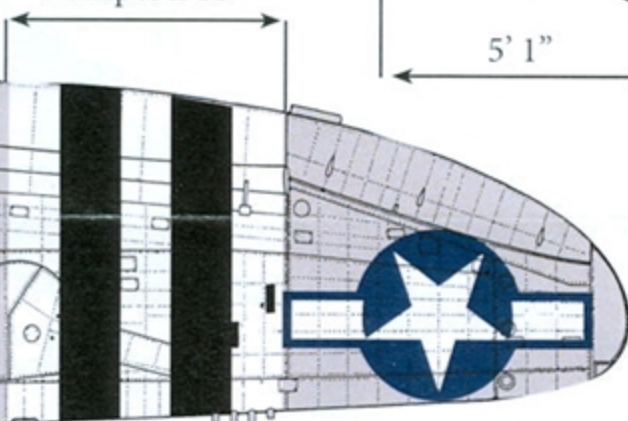

5 stripes x 18"

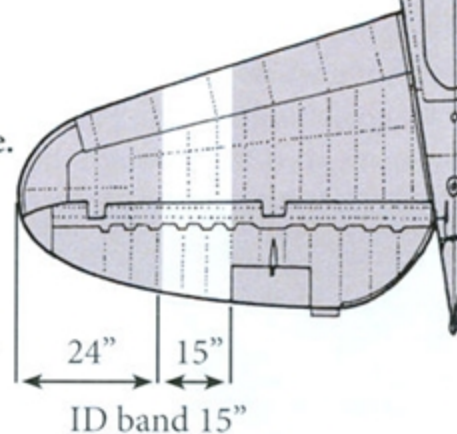

No Guts No Glory and Ozark Queen insignia/NMF decal placement sequence.

For best results apply version 4 insignia/NMF decals in this order:

1. NMF rectangle decal apply inside lower area of vent.
2. Apply national insignia.
3. NMF insignia outline: 1/8" or 3 mm from NMF outline and discard (opposite for right side).
4. wet NMF outline decal and apply under national insignia.
5. Apply Inner insignia/bar piece into the intercooler vent.
6. Paint intercooler door bottom NMF (Kit# 7L/8R or 9L/10R).
7. Apply Bar to intercooler door.

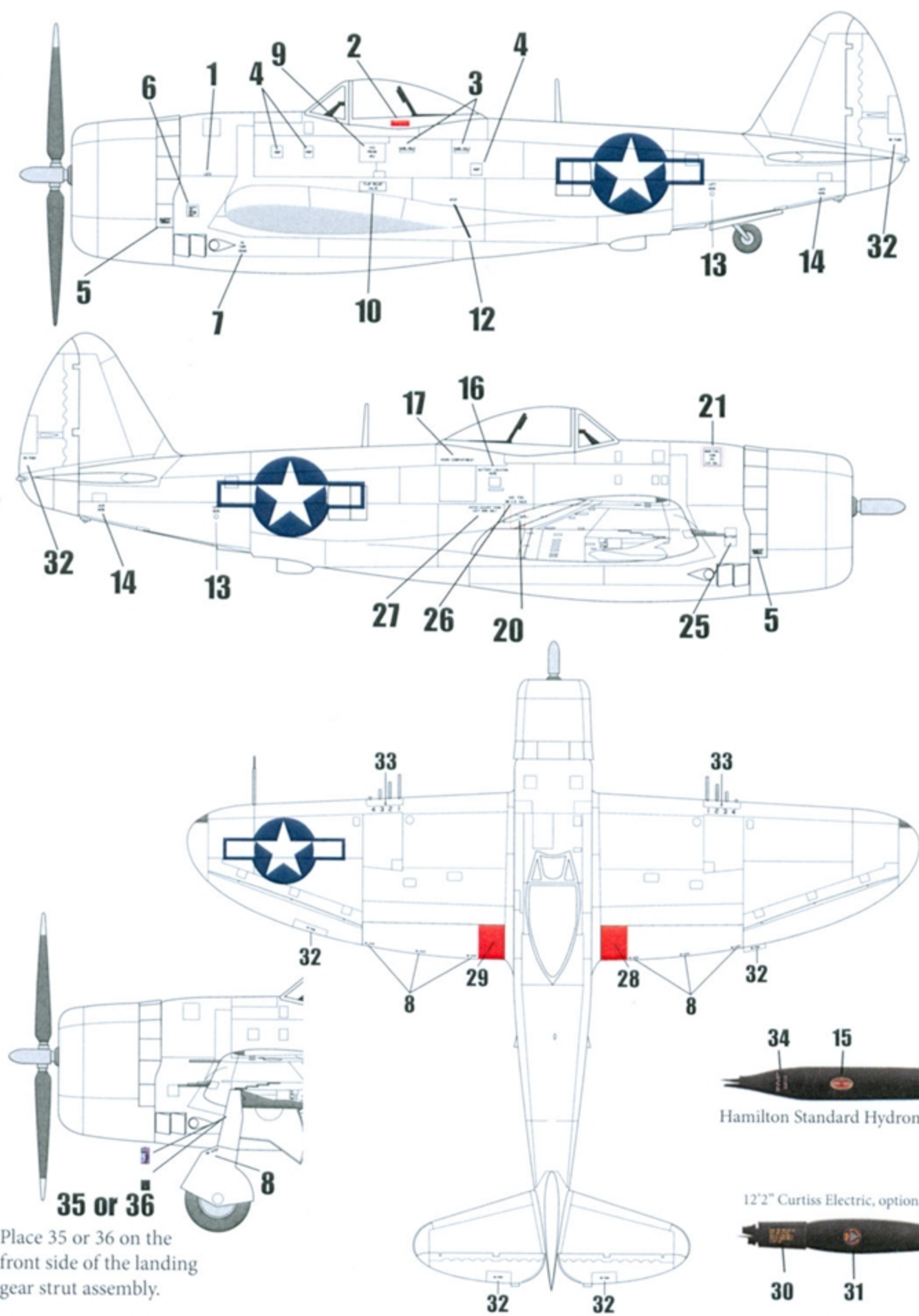

Place 35 or 36 on the front side of the landing gear strut assembly.

Hamilton Standard Hydromatic

12"2" Curtiss Electric, optional?

HS prop is on No Guts, Ozark Queen and Ma Cherie. 12"2" Curtiss Electric on Turnip Termite.

Modeler References

Recommended kits: Tamiya 1/48 P-47D, Razorback/Bubbletop

Aces of the 78th FG Cleaver, Thomas Osprey 2013

Thunderbolts of the Hell Hawks, Barnes, Crump, Sutherland, Barracuda
Graphs, 2011

Eagles of Duxford Turnip Termite, Ma Cherie

78th Fighter Group in WW II, Garry Fry, Phalanx 1991 No Guts No
Glory

Little Friends <http://www.littlefriends.co.uk/> Ozark Queen

American Air Museum in Britain <http://www.americanairmuseum.com/aircraft/18948>

Turnip Termite <http://www.americanairmuseum.com/aircraft/19387> SNAFU

Thanks:

Don Barnes 365th FG Historian; Ma Cherie

Mike Kloppenburg/<http://www.bombshelldecals.com>

Ed Mate/ Ken Scott, 78th FG Checker Graphics

Research: Norris Graser

Copyright © Thundercals Thundercals@yahoo.com

Additional insignia/prop logo's/data available on Thundercals 48005

Also available 48001 P-47D razorback Thunderbolts PTO Pt1 58thFG;
318th FG

48002 P-47D razorback Thunderbolts PTO Pt 2; 318th FG; 348th FG

48003 P-47D razorback Thunderbolts PTO Pt3 58th FG

48004 P-47D razorback Thunderbolts PTO Pt4 318th FG

48005 P-47 Thunderbolt national Insignia Type 4 - data Decals Pt1

Decal info / orders available at Thundercals@yahoo.com

Read the instructions carefully for the particular aircraft insignia usage.
Proper placement for the 50" insignia.

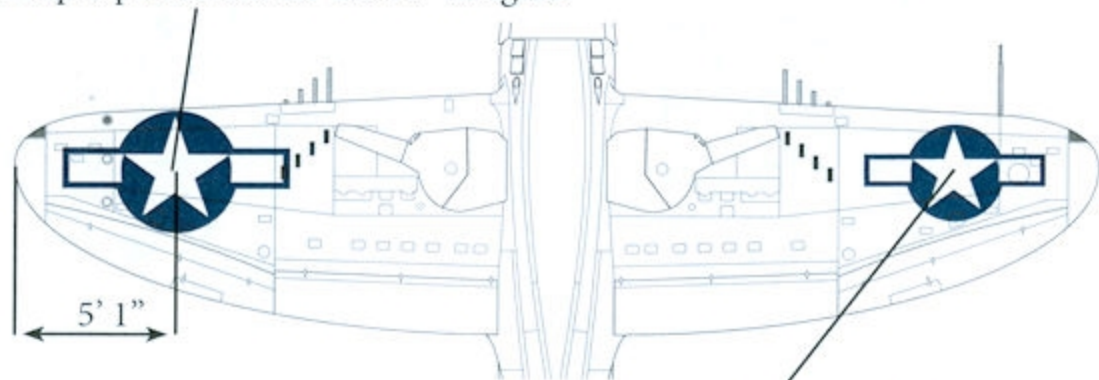

Placement for the 40" insignia.