

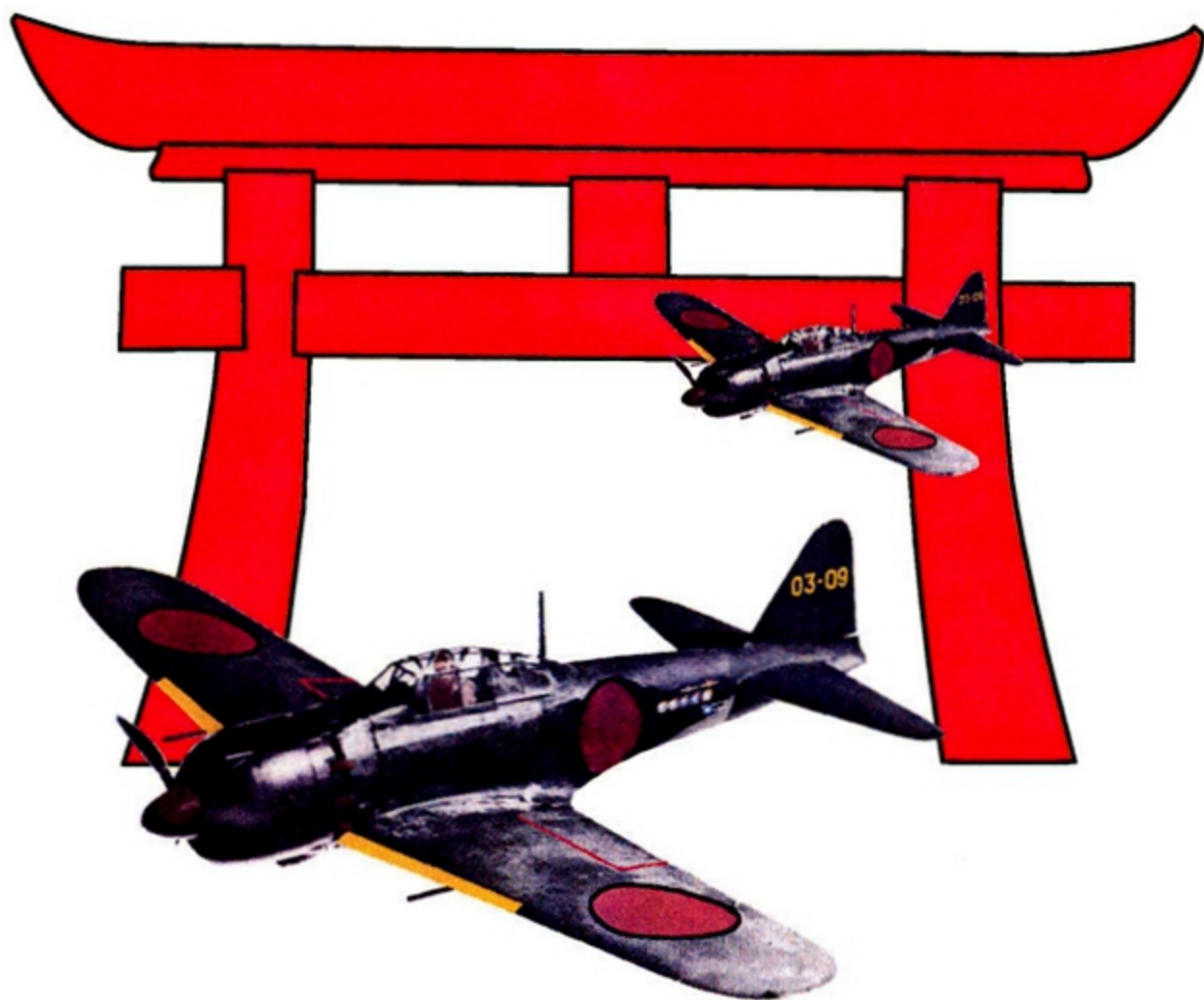

# 暁の鷲

暁の鷲  
Rising Sun



Aeromaster Decals™

SP48-04



# Aeromaster Decals™



KI 27: Shinohara, IJAAF

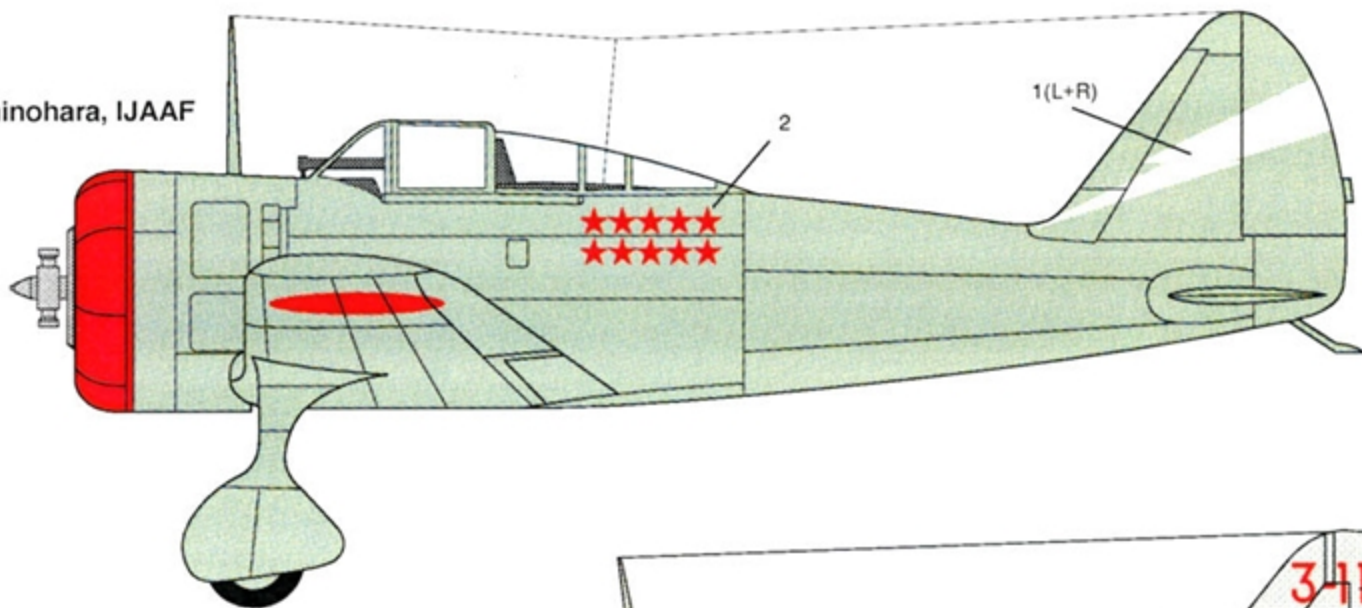

A6M2a: Suzuki, IJNAF

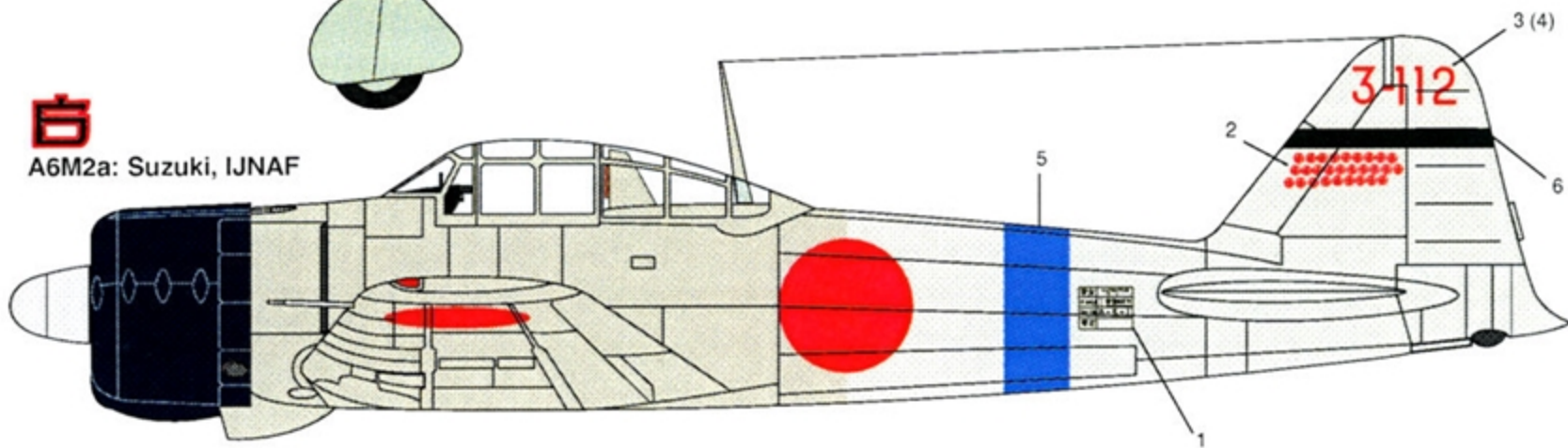

A6M2b: Hashiguchi, IJNAF

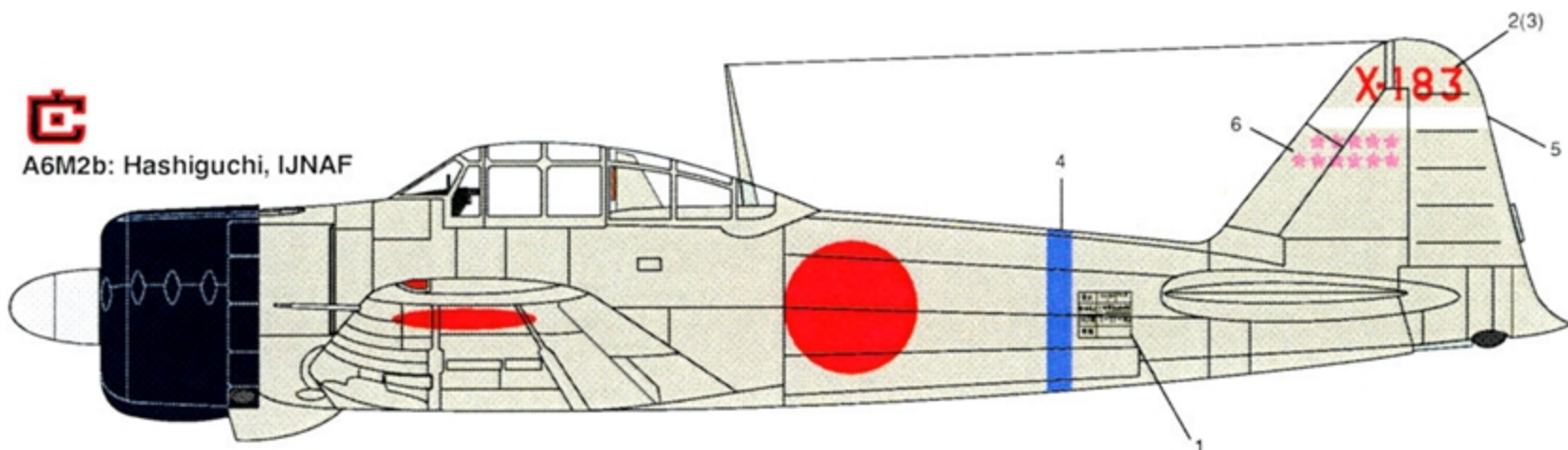

A6M2b: Ishihara, IJNAF

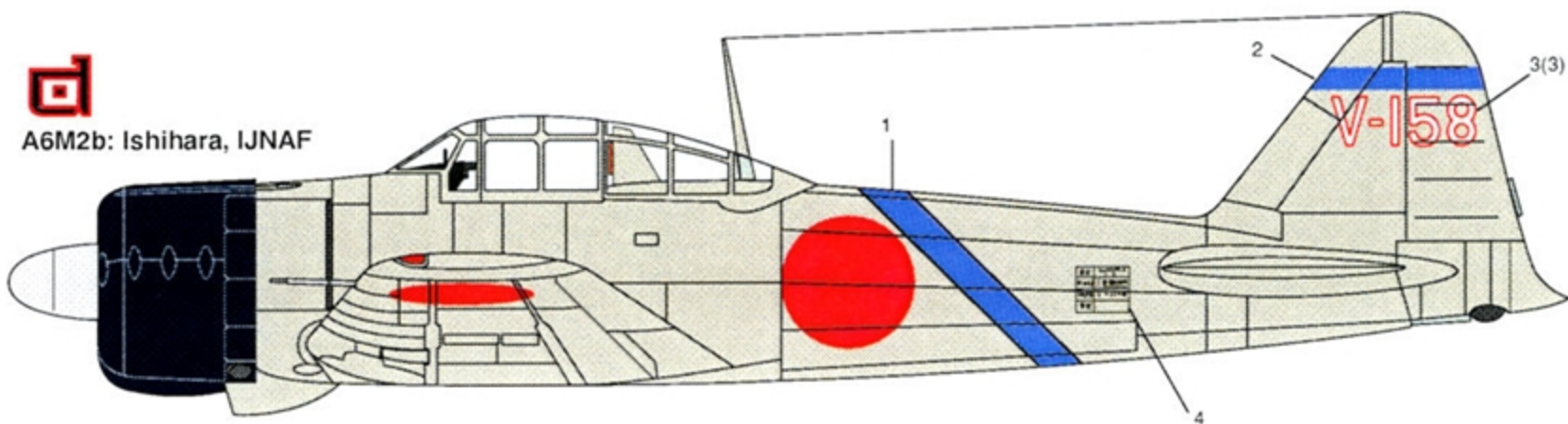



# Aeromaster Decals™



A6M2b: Sakai, IJNAF

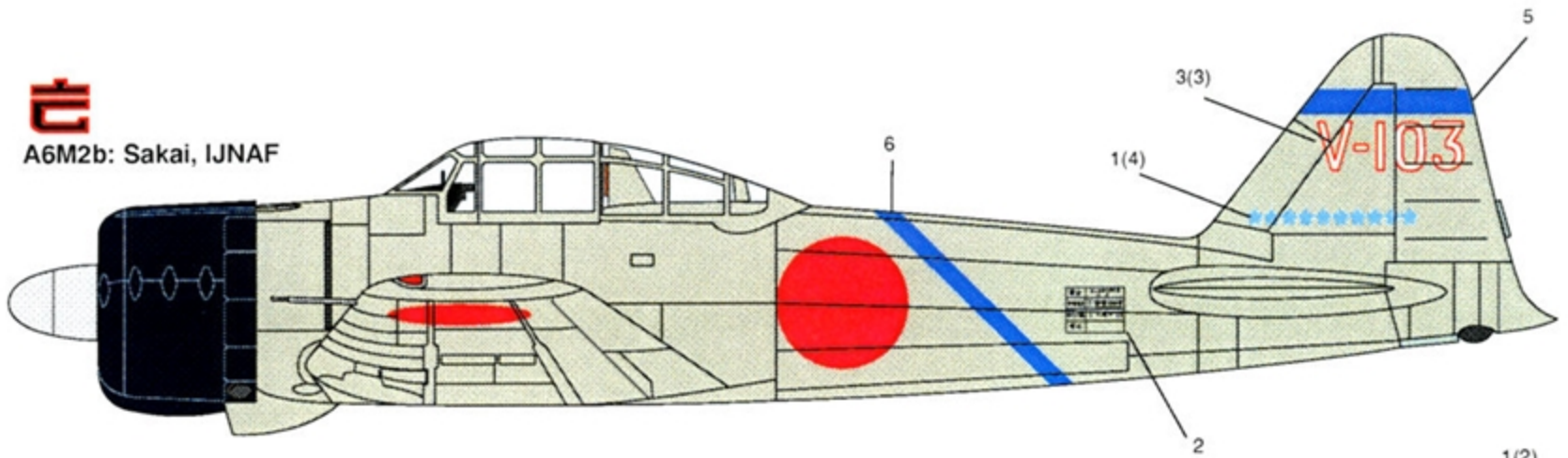

KI 43-I: Kato, IJAAF

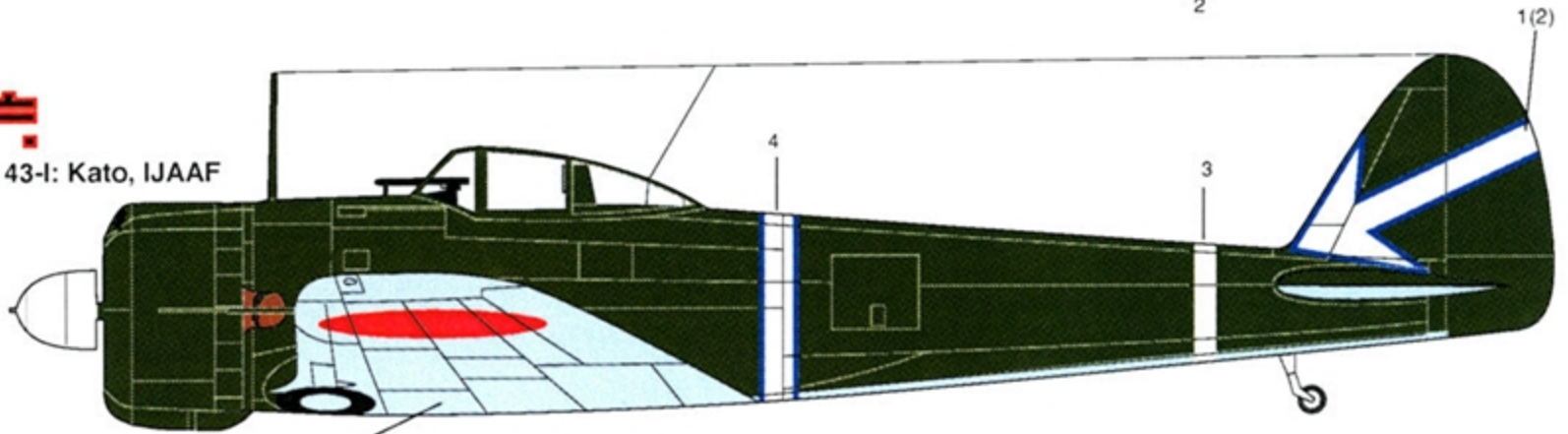

5(6) on top of wings.  
See MODEL BUILDING SUGGESTIONS  
AND NOTES



KI 43-I: Anabuki, IJAAF

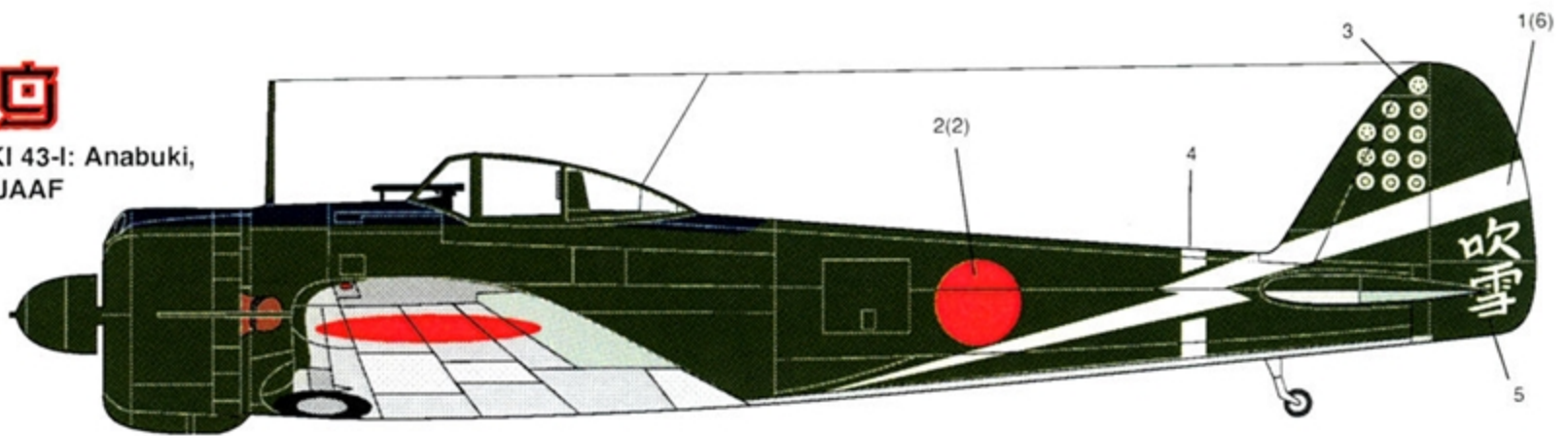

KI 43-II Kou: Nango, IJAAF

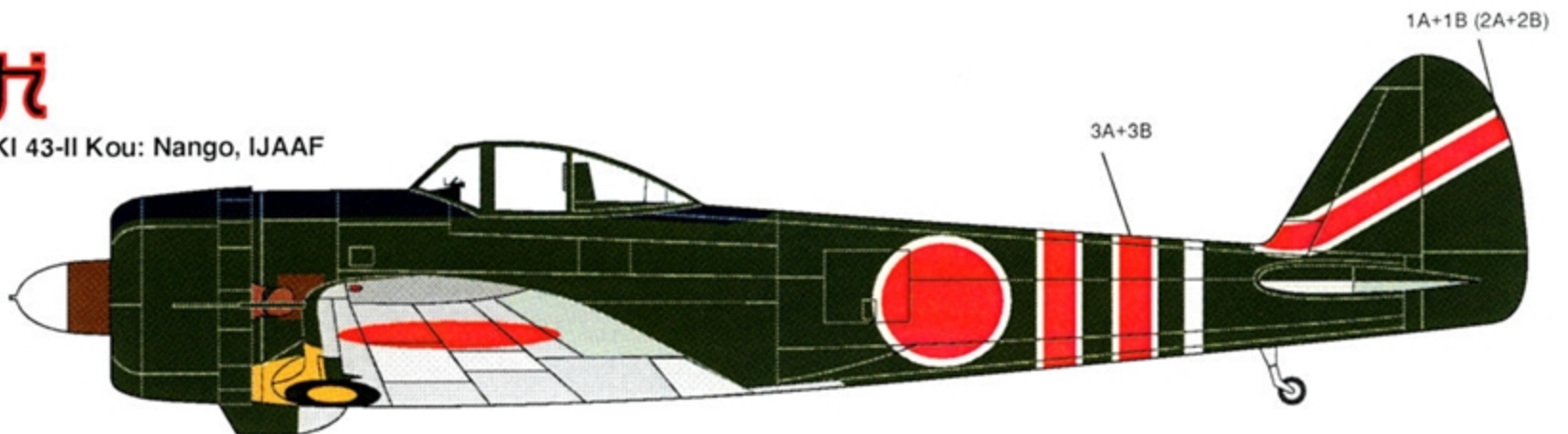



# AeroMaster Decals™

**t**

A6M3: Nishizawa, IJNAF

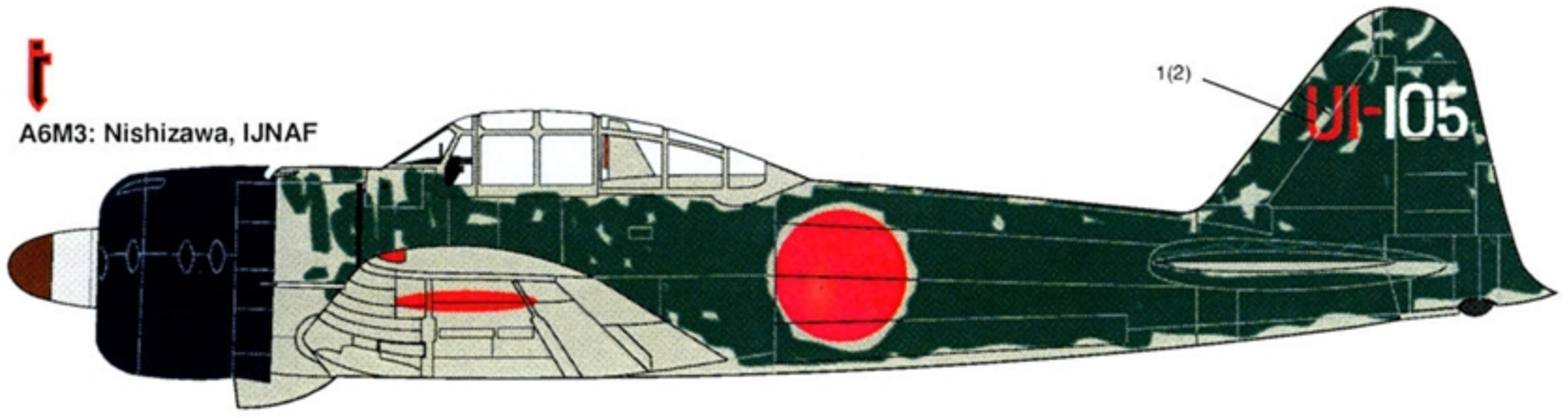

**j**

A6M3: Ito, IJNAF

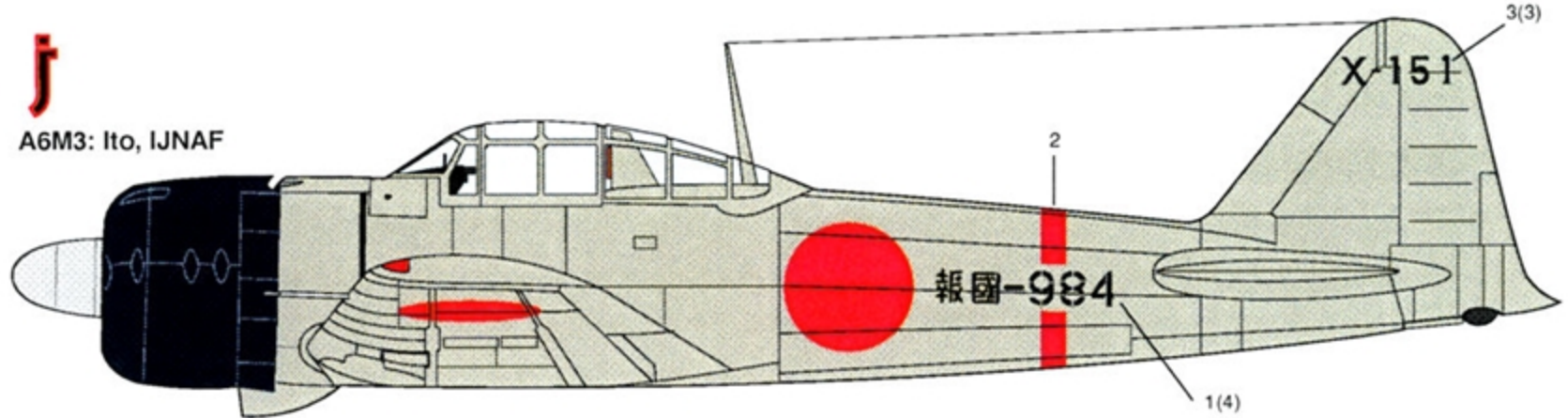

**k**

KI 61-I Otsu: Takeuchi, IJAAF

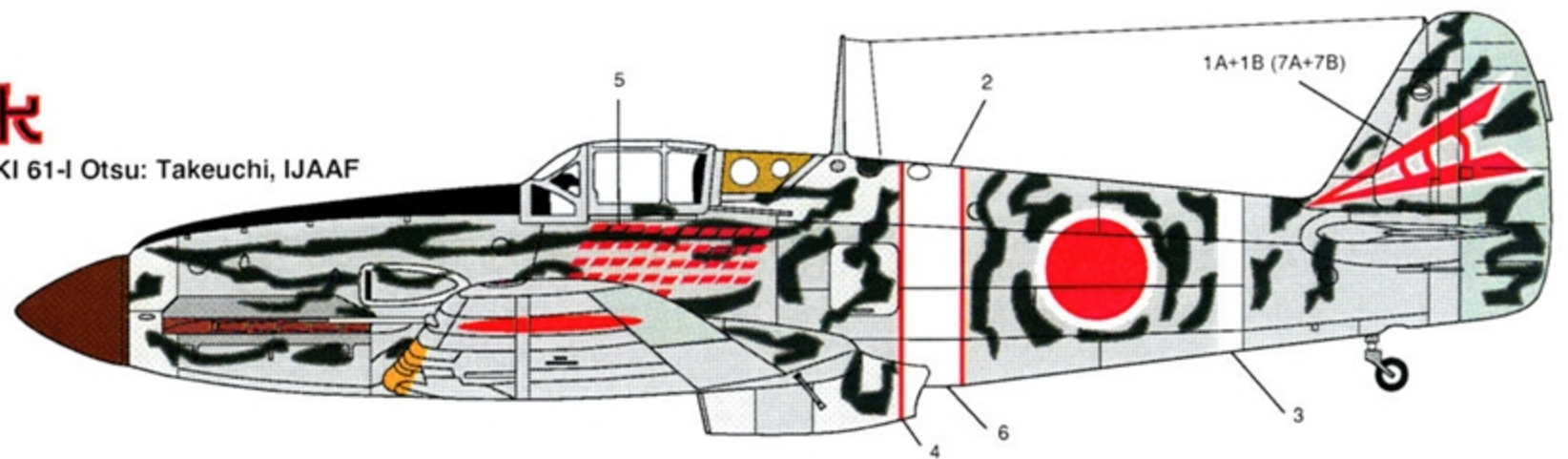

**l**

A6M3: Iwamoto, IJNAF

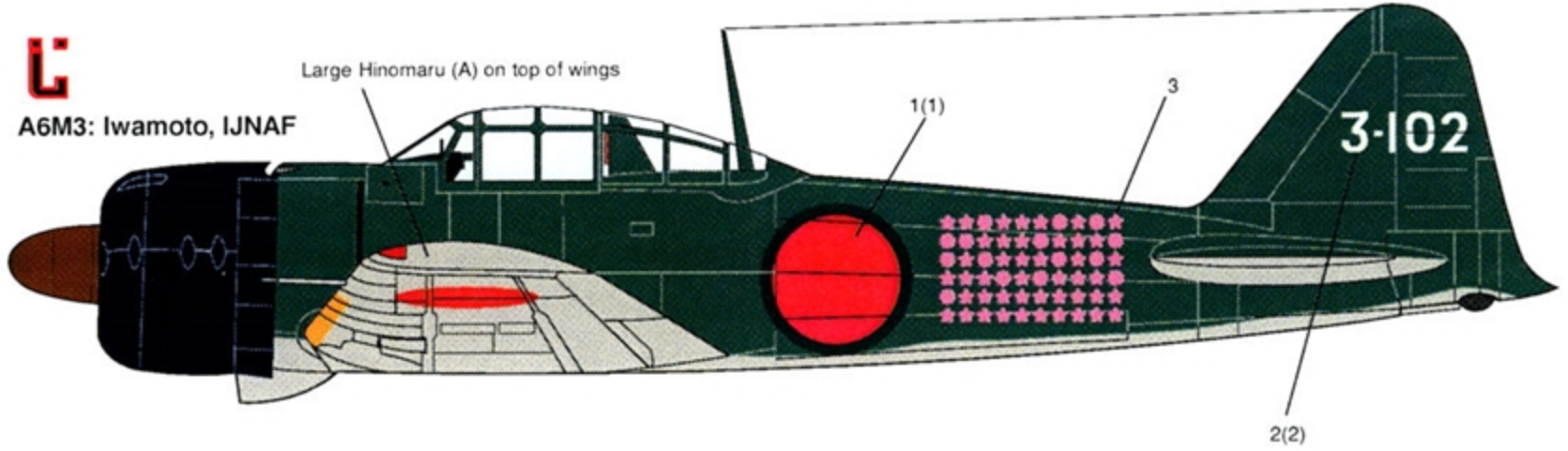



# AeroMaster Decals™



KI 43-II Otsu:  
Sakagawa,  
IJAAF

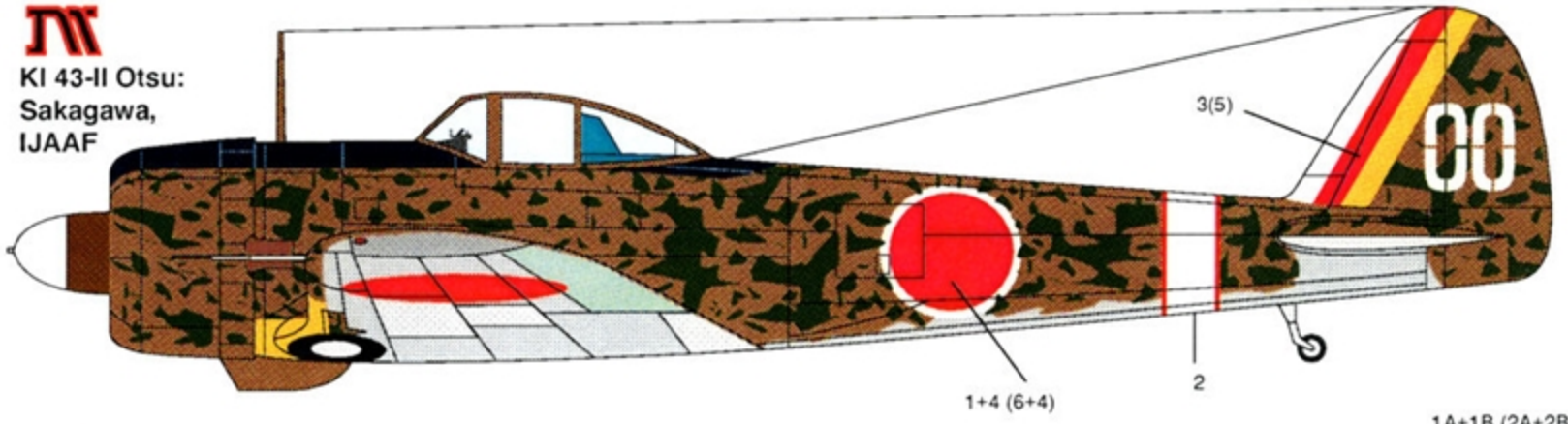

KI 44-II Otsu: Wakamatsu,  
IJAAF

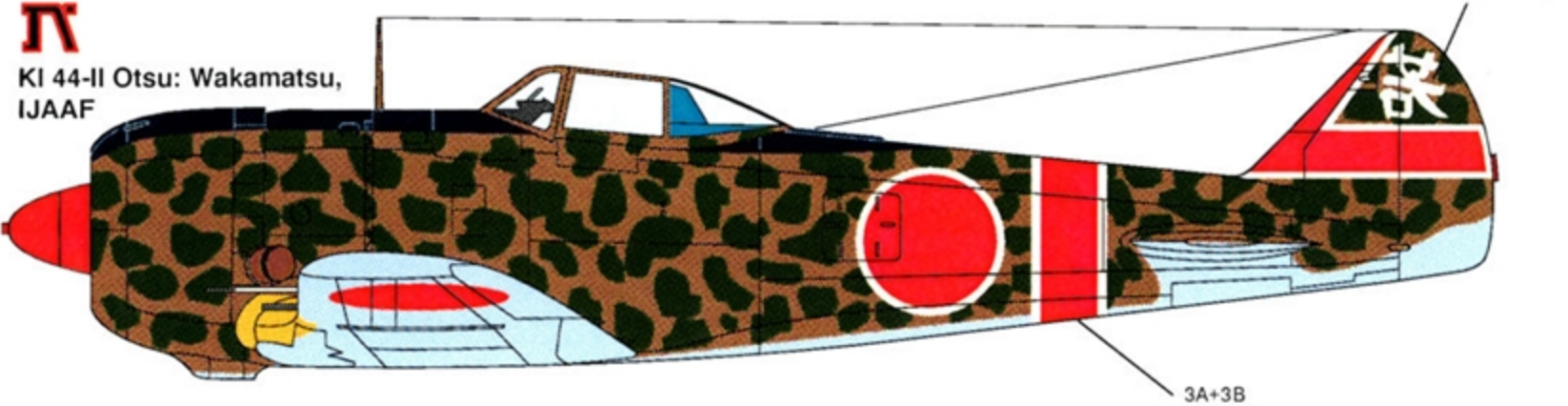

N1K2-J: Sugita, IJNAF

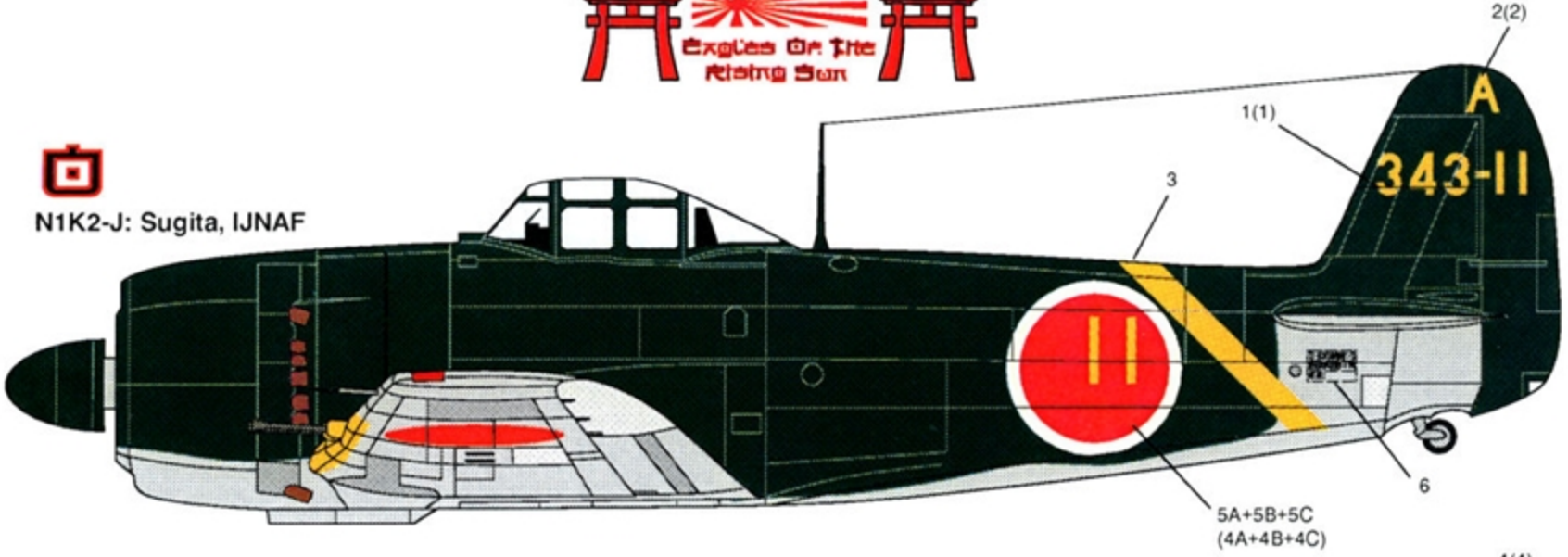

N1K2-J: Kanno, IJNAF

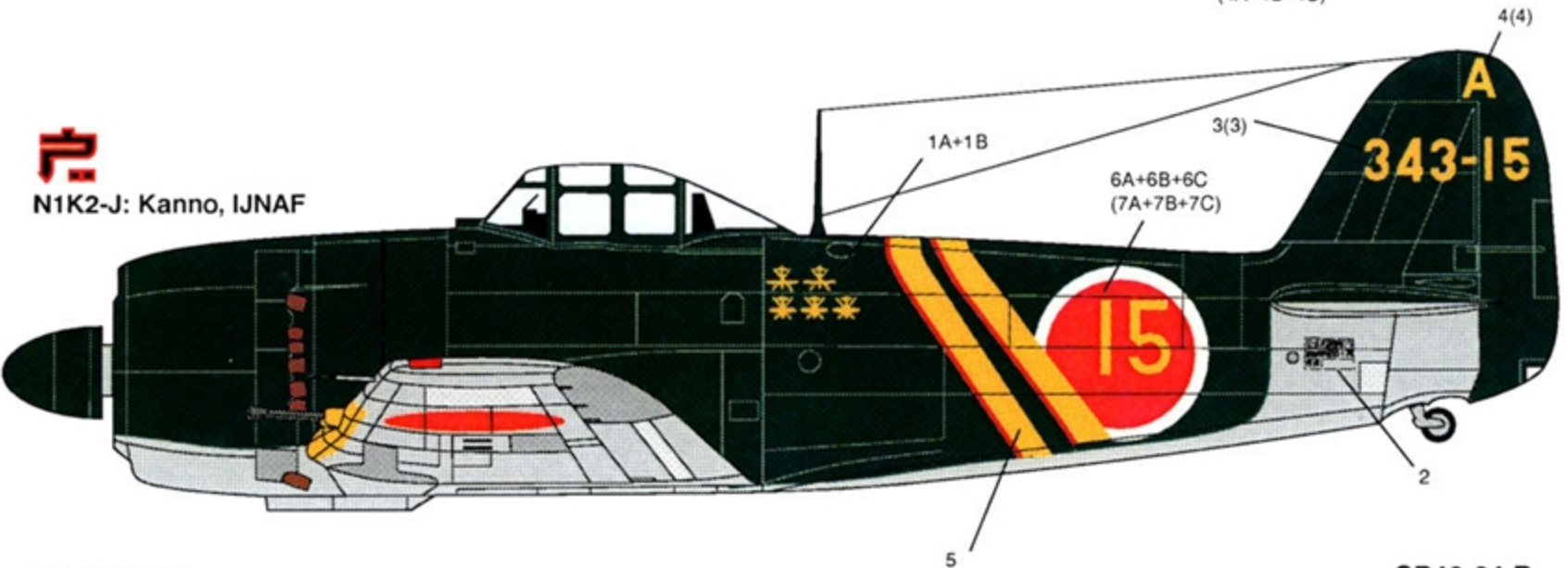



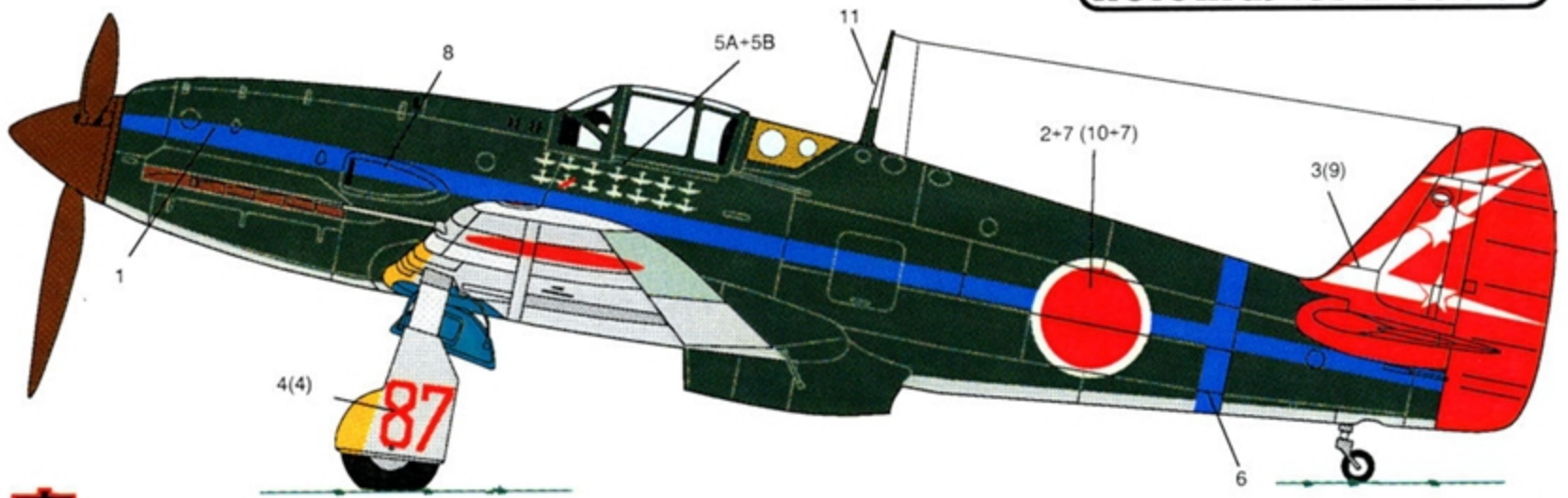

**向** KI 61-I Tei: Kobayashi, IJAAF

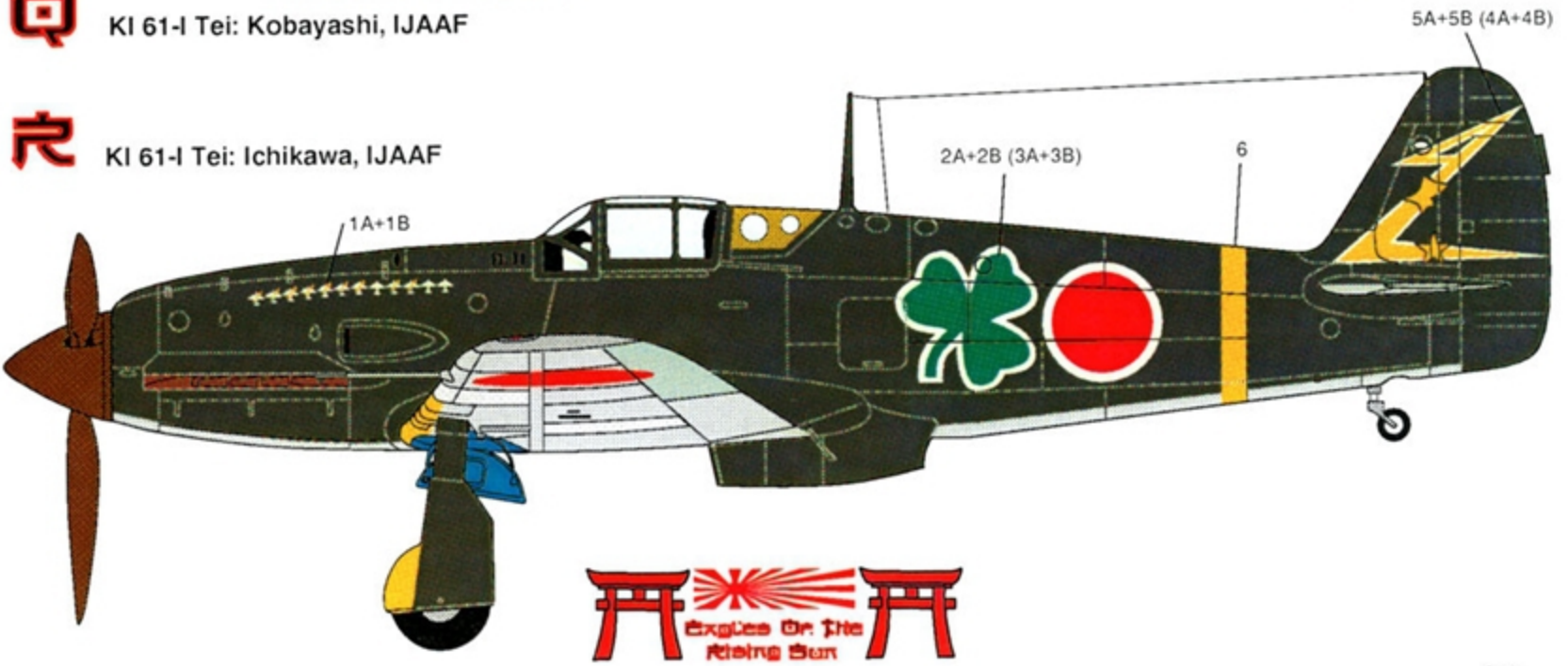

**向** KI 61-I Tei: Ichikawa, IJAAF

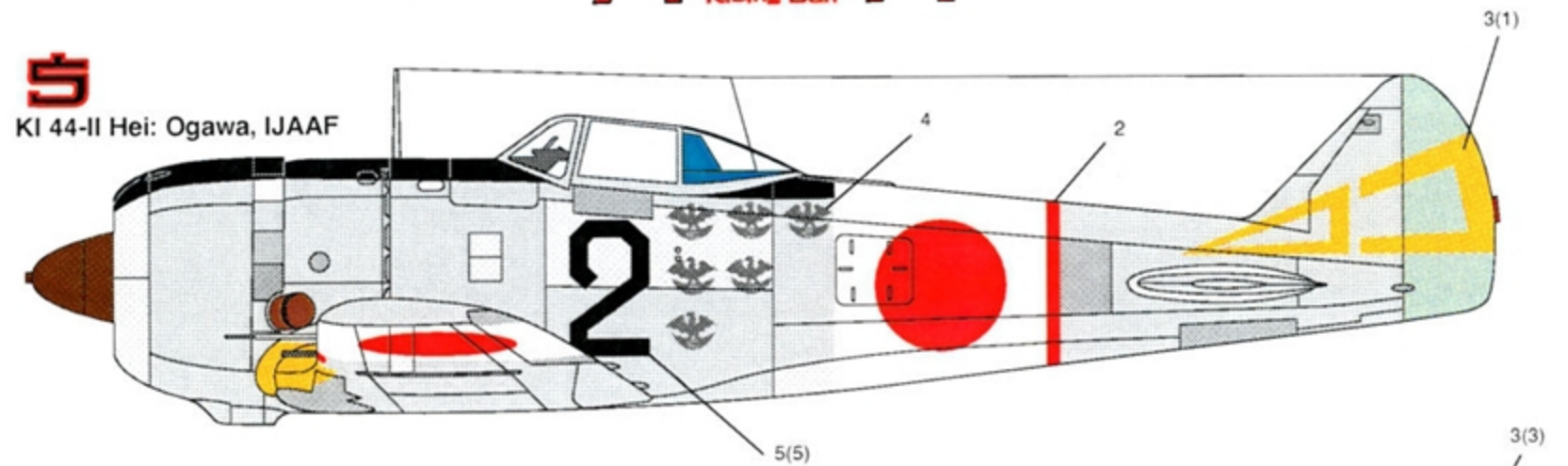

**向** KI 44-II Hei: Ogawa, IJAAF

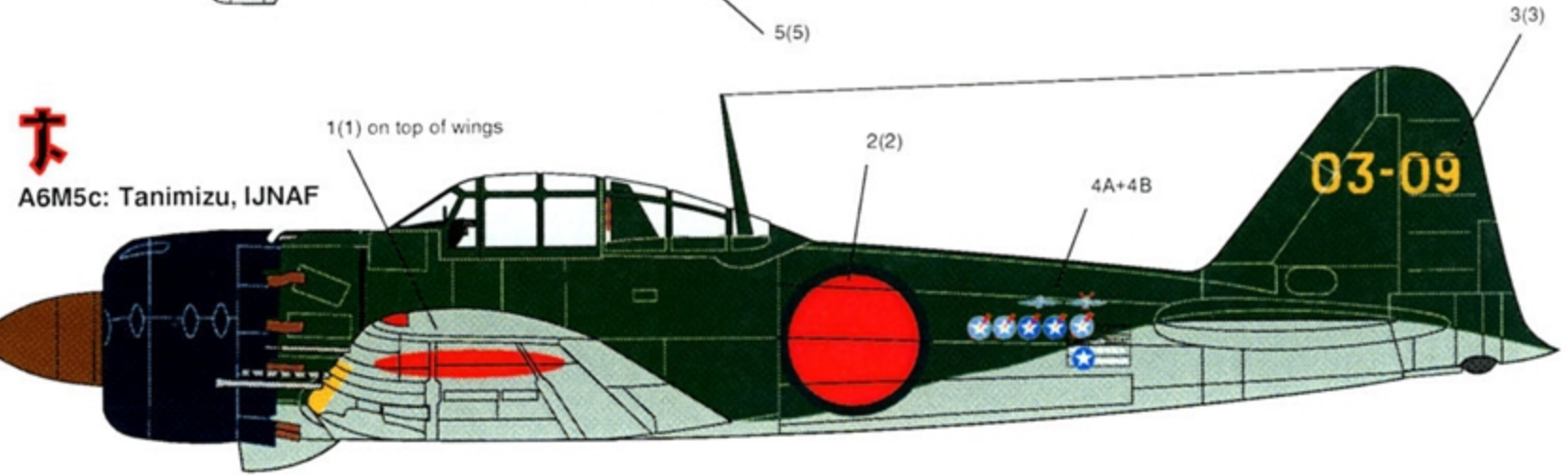

**向** A6M5c: Tanimizu, IJNAF





## EAGLES OF THE RISING SUN

### MODEL BUILDING SUGGESTIONS AND NOTES

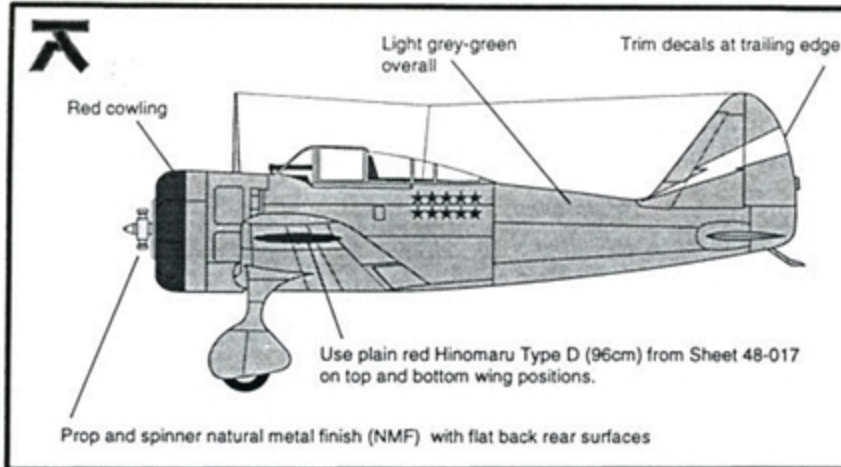

Ki 27 Otsu, Shimada Chutai, 11th Sentai, flown by WO Hiromichi Shinohara, Nomonhan, Manchuria, June 1939. Aircraft had 10 kills at this time but Shinohara's final score was 58.

A6M2a Model 11 Zero, 3-112, 12th Kokutai, flown by Lt. Minoru Suzuki (final score: approx. 8), China, Winter 1940-1941. The tail score includes kills from other pilots who flew this airplane.

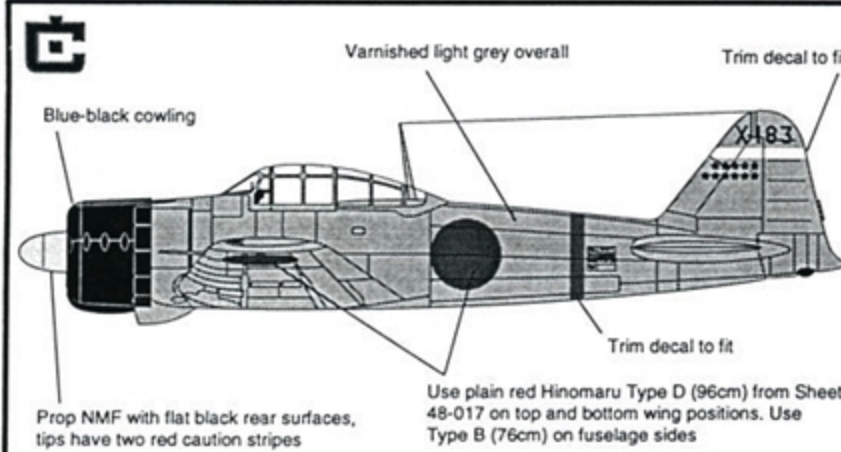
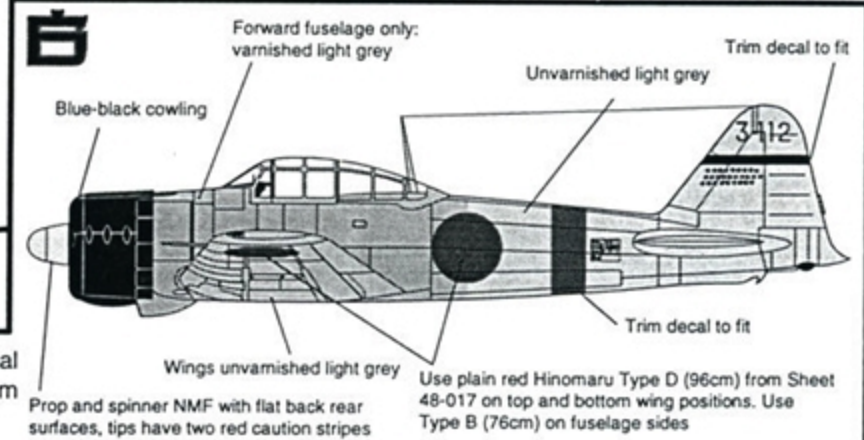

A6M2b Model 21 Zero, X-183, 3rd Kokutai, flown by NAP 2/C Yoshiro Hashiguchi (final score: 10+), Kendari AB, Celebes, February 1942.

A6M2b Model 21 Zero, V-158, Tainan Kokutai, flown by NAP 2/C Susumu Ishihara (final score: 16), Surabaya AB, Java, February, 1942

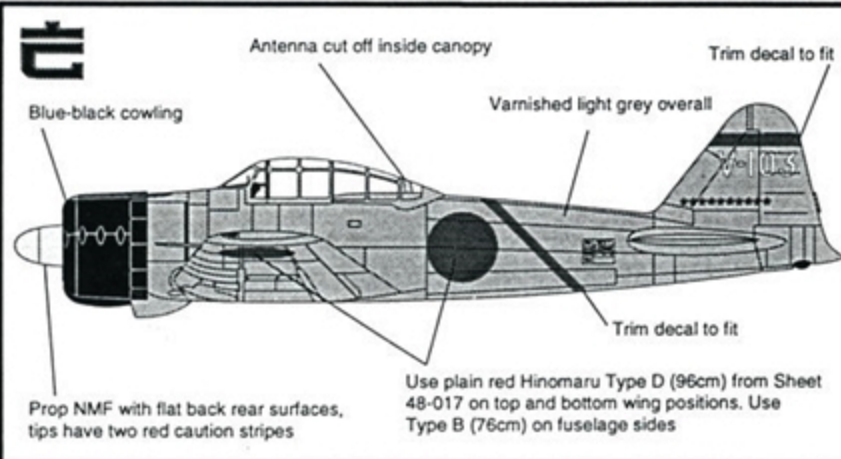
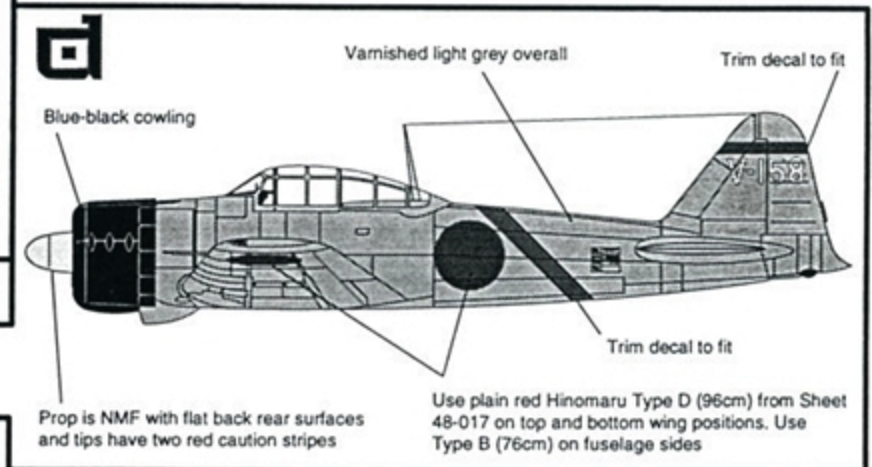

A6M2b Model 21 Zero, V-103, Tainan Kokutai, flown by NAP 1/C Saburo Sakai, Denpasar AB, Bali, February, 1942. Sakai's final score was 64.



**SPECIAL THANKS**  
To KEISHIRO NAGAO  
for translations and corrections of original  
Japanese materials





# MODEL BUILDING SUGGESTIONS AND NOTES-2



**g**

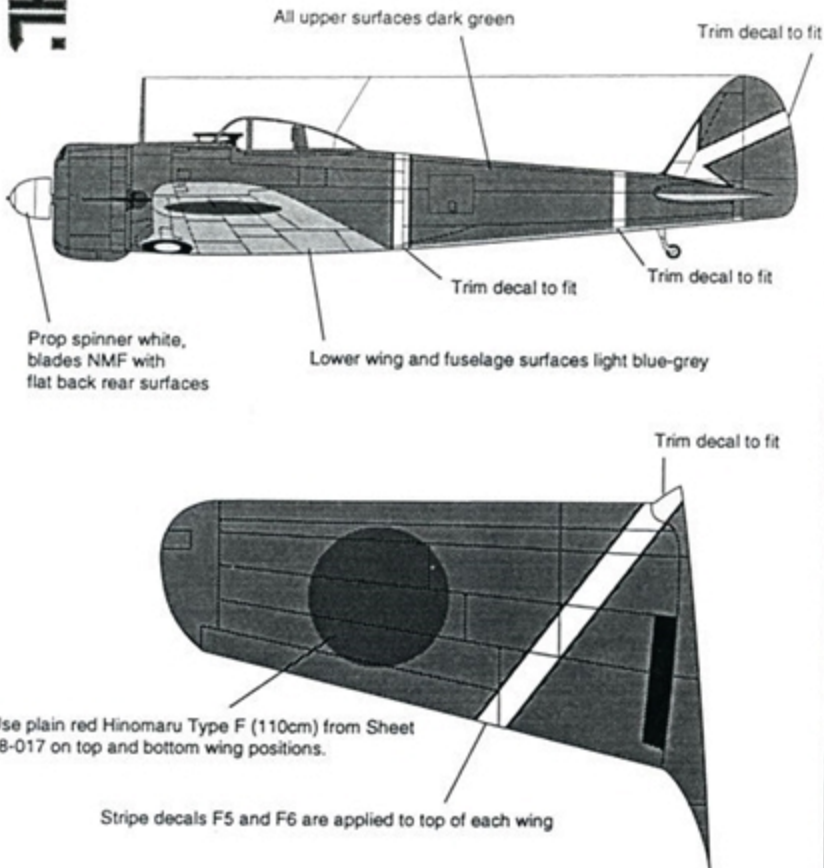

Ki 43-I Hayabusa, 64th Sentai, flown by sentai commander, Lt. Col. Tateshi Kato, Burma, May 1942. Kato had a final score of 18 kills.

**g**

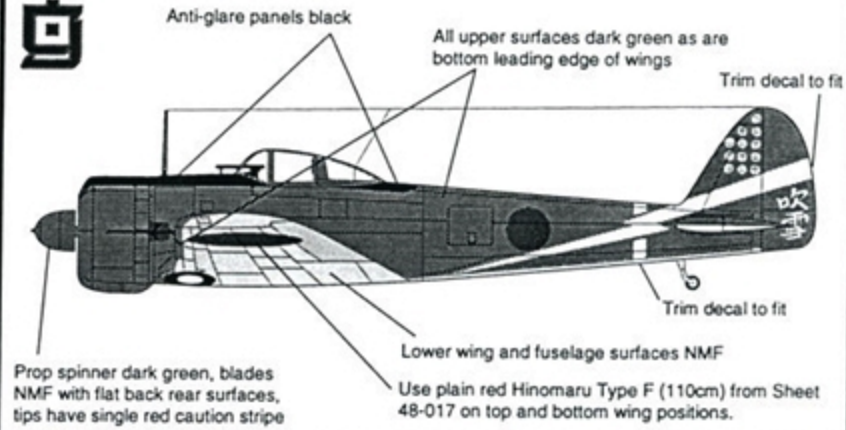

Ki 43-I Hayabusa, 50th Sentai, flown by Sgt. Satoshi Anabuki, Burma, January 1943. Anabuki had a final score of 39 kills. Note that fabric control surfaces on NMF finishes are painted Army light grey-green.

**h**

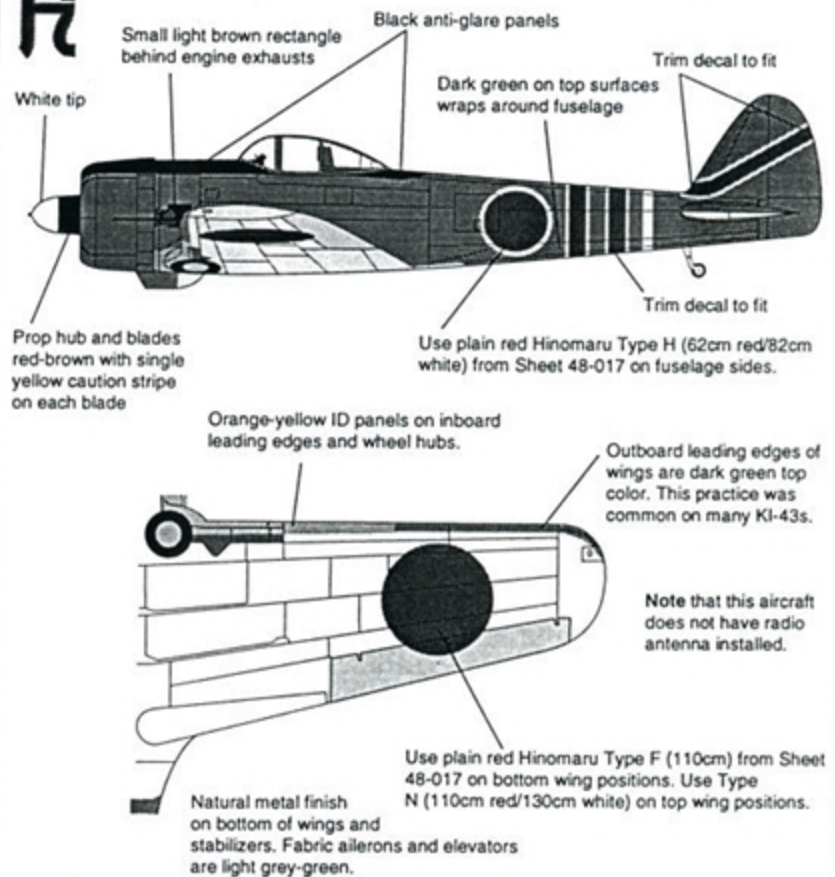

A6M3 Model 22 Zero, UI-105, 251st Kokutai, flown by NAP 1/C Hiroyoshi Nishizawa, Rabaul, June 1943. Nishizawa's final score was 87. The spinner tip paint was peeling off and aircraft had a standard droptank.

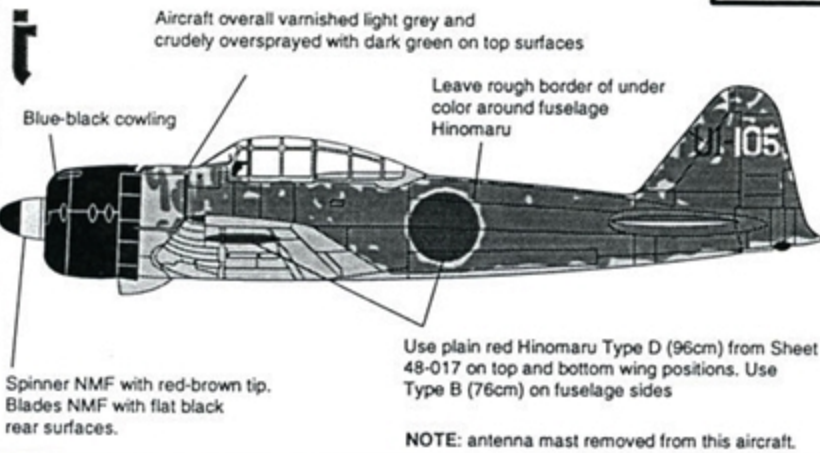

**j**

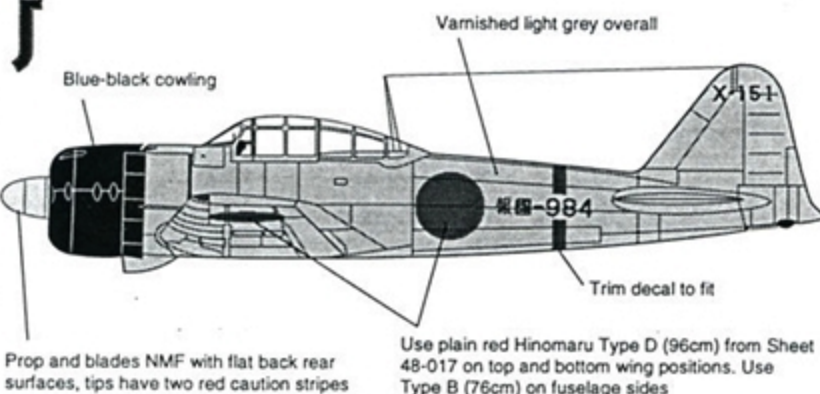

Ki 43-II Kou Hayabusa, 59th Sentai, 2nd Chutai, flown by Capt. Shigeo Nango, New Guinea, 1943. Nango had a final score of 15 kills. Aircraft photographed with single ID yellow drop tank on left inboard wing pylon.

A6M3 Model 22 Zero, X-151, 202nd Kokutai, flown by NAP 1/C Kiyoshi Ito, Kupang AB, Timor, Spring 1943. Ito had a final score of 17. Aircraft had simple type outboard wing bomb racks.





# MODEL BUILDING SUGGESTIONS AND NOTES-3

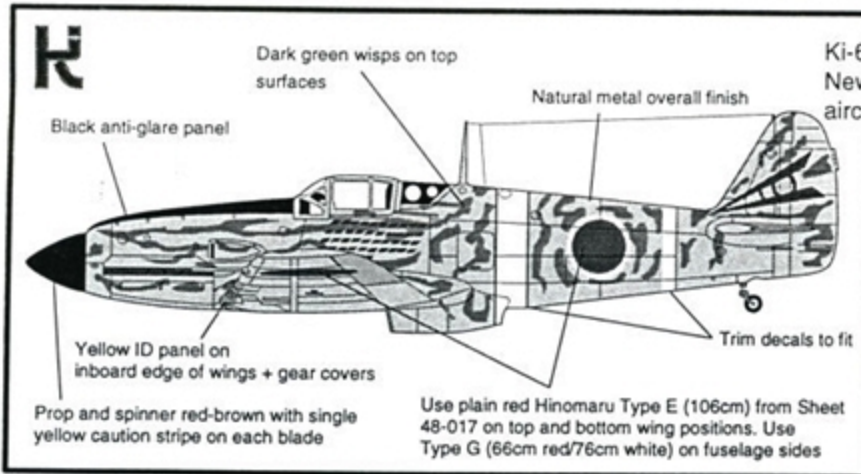

Ki-61-I Otsu Tony, 68th Sentai, of Maj. Shogo Takeuchi (final score: 19), New Guinea, late 1943. Kill marks include probables and damaged aircraft.

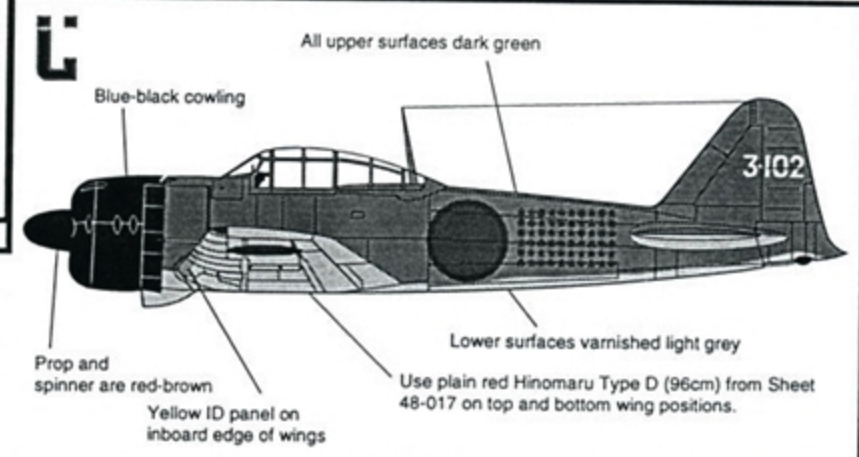

A6M3 Model 22 Zero, 3-102, 253rd Kokutai, flown by WO Tetsuzo Iwamoto (final score: 80), Rabaul, January 1944. References are not clear: some believe it was a Model 21, generally out of service at this time. Iwamoto's diary gives only the "102" portion of the tail code. The unit code prefix changed in 1943 from U3 to an unknown arabic number. Based on contemporary Rabaul units, the code 3-102 is most probable.

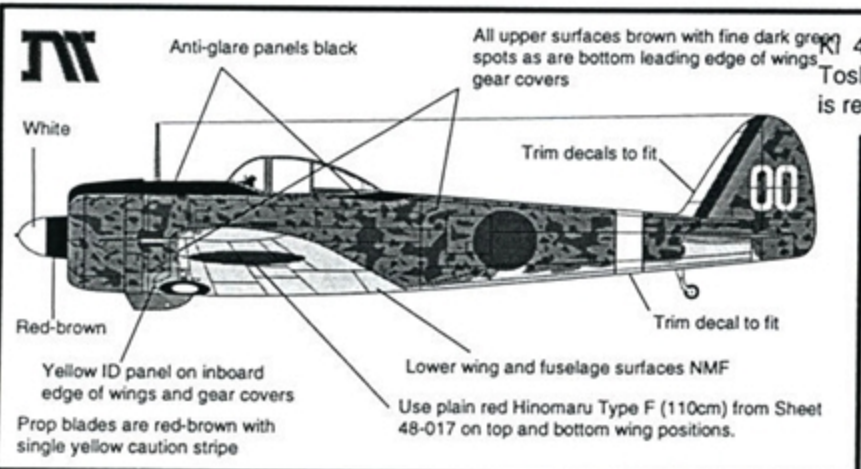

Ki-43-II Otsu Hayabusa, 25th Sentai, flown by unit commander, Major Toshio Sakagawa (final score:15), Hankow, China, Spring 1944. Headrest is removed from this aircraft.

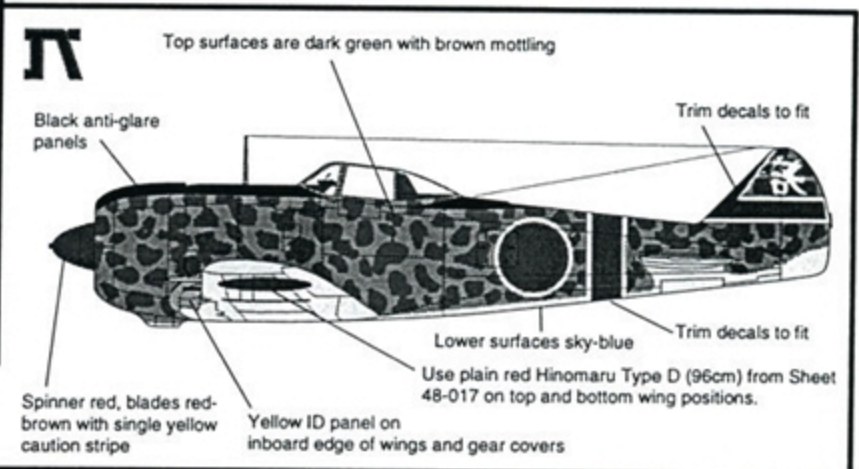

Ki-44-II Otsu Shoki, 85th Sentai, 2nd Chutai, flown by Lt. Col. Yukiyoishi Wakamatsu (final score: 18+), Kwangtung, China, 1944.

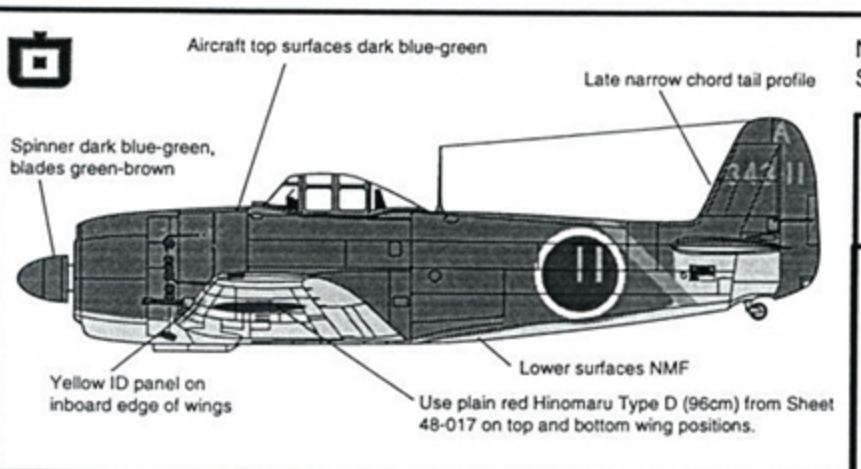

N1K2-J Shinden, 343-11, 343rd Kokutai, flown by NAP 1/C Shoichi Sugita, Matsuyama, Japan, April 1945. Sugita had a final score of 70.

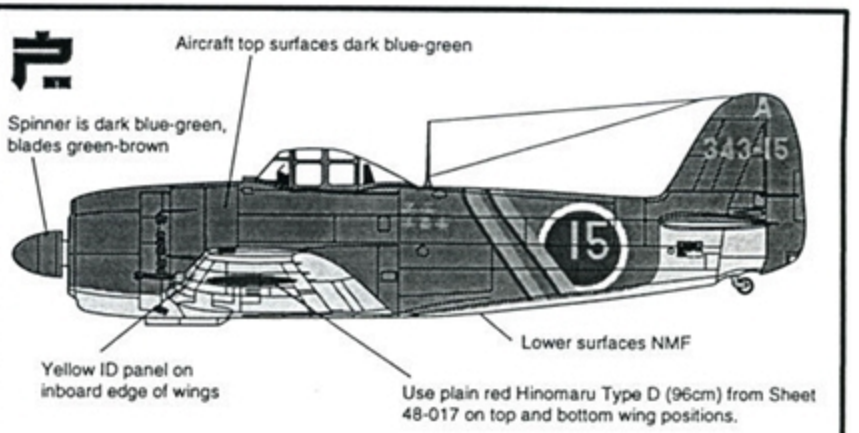

N1K2-J Shinden, 343-15, 343rd Naval Air Group, flown by Capt. Naoshi Kanno (final score 25), Matsuyama, Japan, April 1945. The five kill marks, were forward of the stripe, but shape and location are based on displays on other unit aircraft. Front half of spinner is believed to have been later painted yellow at Ohmura AB, late April 1945.



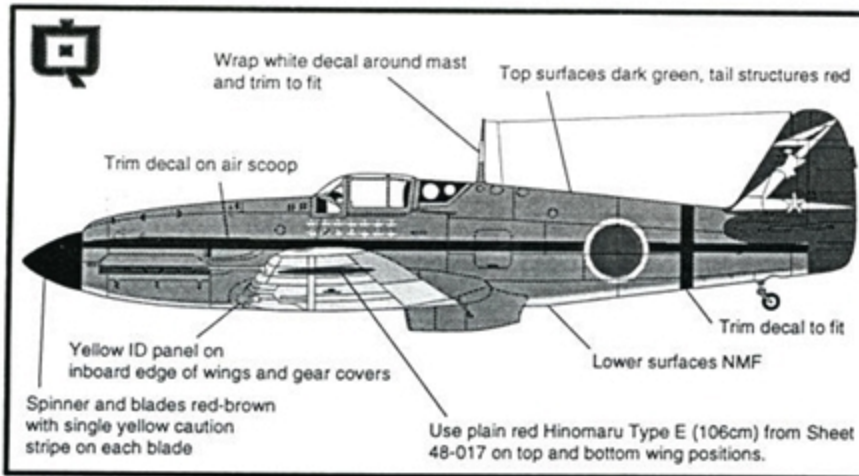

Ki-61-I Tei, 244th Sentai, flown by sentai commander Maj. Teruhiko Kobayashi, Chofu, Japan, May 1945. Some of his 12 kills were achieved by "body attack." As opposed to "ramming," body attacks were achieved by landing on top of an enemy aircraft in flight, after which the pilot bailed out.

Ki-61-I Tei, 3rd Chutai, 244th Sentai, flown by Capt. Chuichi Ichikawa (final score: 10+), Chofu, Japan, Summer 1945. Landing gear covers believed to have had two-digit white number (representing aircraft's serial) on lower side of main gear covers. Exact number is not known.

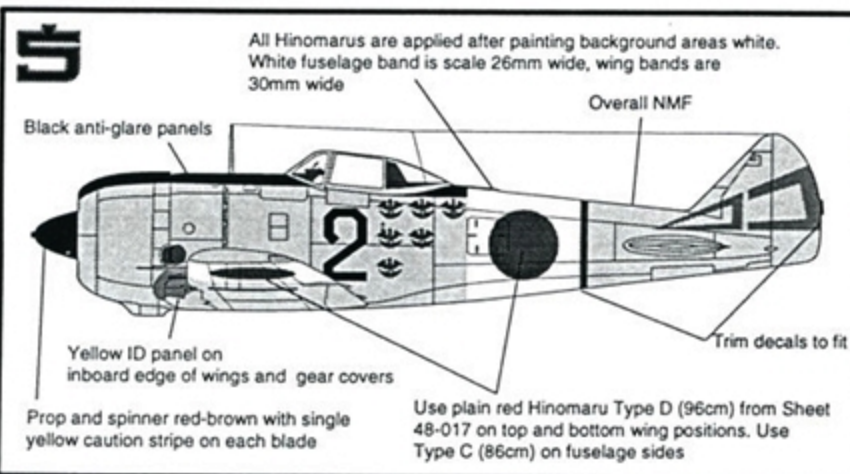
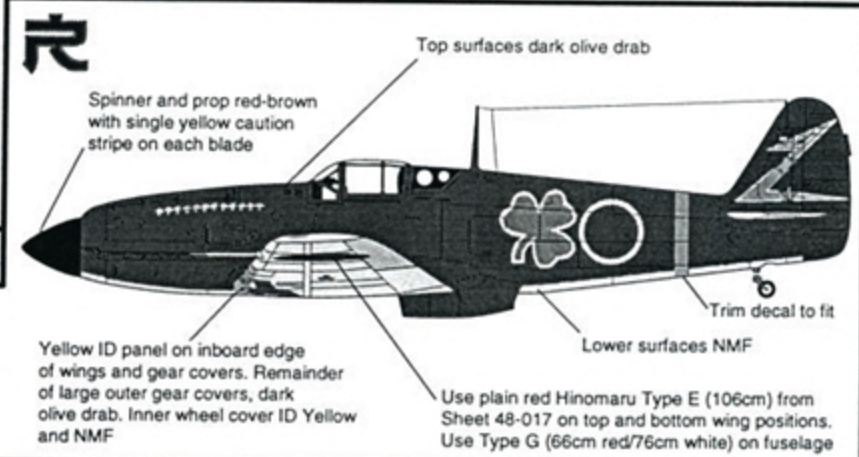

Ki 44-II Hei Shoki, 70th Sentai, 3rd Chutai, flown by 2nd Lt. Makoto Ogawa, Chiba, Japan, June 1945. Ogawa's final score was 9.

A6M5c Hei Model 52 Zero, 03-09, 303rd Hikotai, 203rd Kokutai, flown by WO Takeo Tanimizu, Kagoshima, Japan, June 1945. Tanimizu had a final score of 18. This aircraft had large-capacity wooden drop tank.

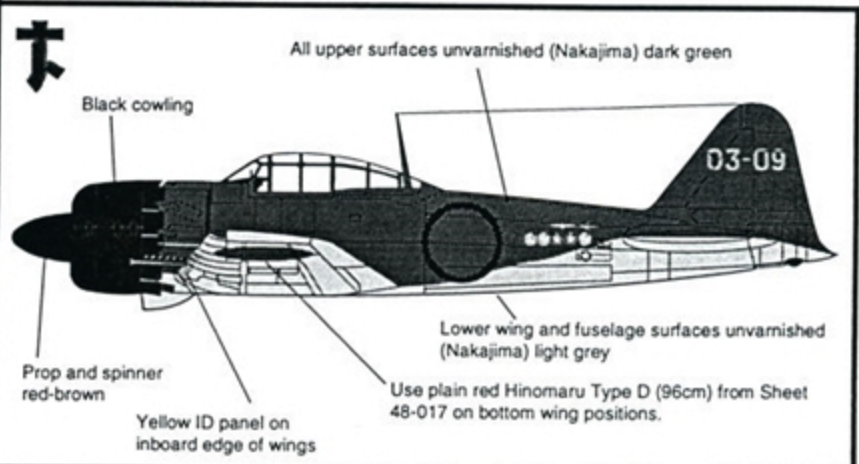

## REFERENCES USED:

- 1) ZERO IN ACTION, by Shigeru Nohara, 1983. Squadron Signal Publications, 49 p. Good general reference on Zero with lots of photos and artwork.
- 2) MEDALED PILOTS OF THE JAPANESE AIR FORCE, NO. 416, 1993. Model Art Publications, 144 p. Excellent photo and artwork reference on Ki 43, Ki 44, Ki 61 and other types used by Japanese Army forces. Japanese text.
- 3) CAMOUFLAGE & MARKINGS OF TYPE 1 FIGHTER HAYABUSA, NO. 395. 1992. Model Art Publications, 158 p. Excellent coverage of the Ki-43 with many photographs. Japanese text.
- 4) Koku-Fan Magazine, various issues. Bunrin-Do Publishing.
- 5) JAPANESE IMPERIAL ARMY AND NAVY AIRCRAFT COLOR, MARKING, NO. 42, 1988. Koku-Fan Illustrated, Bunrin-Do Pub., 176 p. Excellent book with color artwork, photos and other details. Japanese text.

## RECOMMENDED KITS:

Tamiya: A6M ZERO (family);  
 Hasegawa: N1K2-J GEORGE; KI 61 TONY; KI 44 TOJO; A6M ZERO (family); KI 27 NATE  
 Nichimo: KI 43-I OSCAR  
 Fine Molds: KI 43 OSCAR (family)  
 Otaki/Arii: Ki-44 TOJO; Ki-43 OSCAR; Ki-61 TONY; A6M5 ZERO