

AC72-0039
AC48-0039

Microscale Decals F-14 Tomcat Data with unarmed missile markings

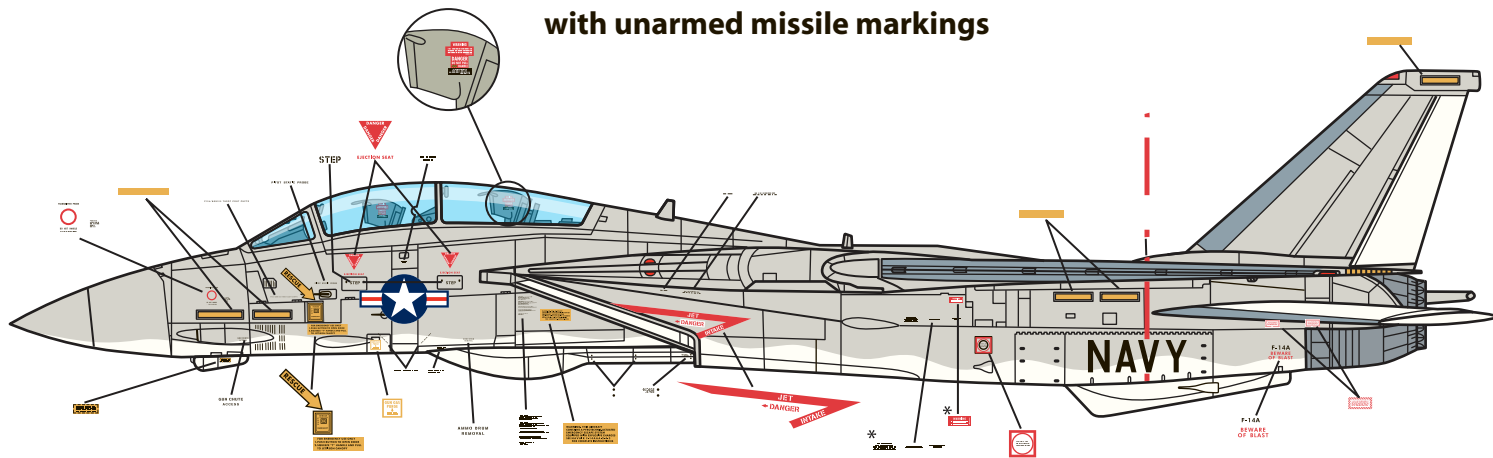

Phoenix missile pallets are painted the underside color of the F-14's in any particular squadron. If the Squadron has a mix of Lt. Gull Gray and White aircraft, along

with overall Lt. Gull Gray aircraft, you may see Gray missile pallets on Gray/White aircraft and White missile pallets on overall Gray aircraft.

The Gray carried on F-14's is Lt. Gull Gray FS 36440. This color has a slight gloss sheen to it. Undersurface White is FS 27875. Leading edges on all flying surfaces are Natural Metal.

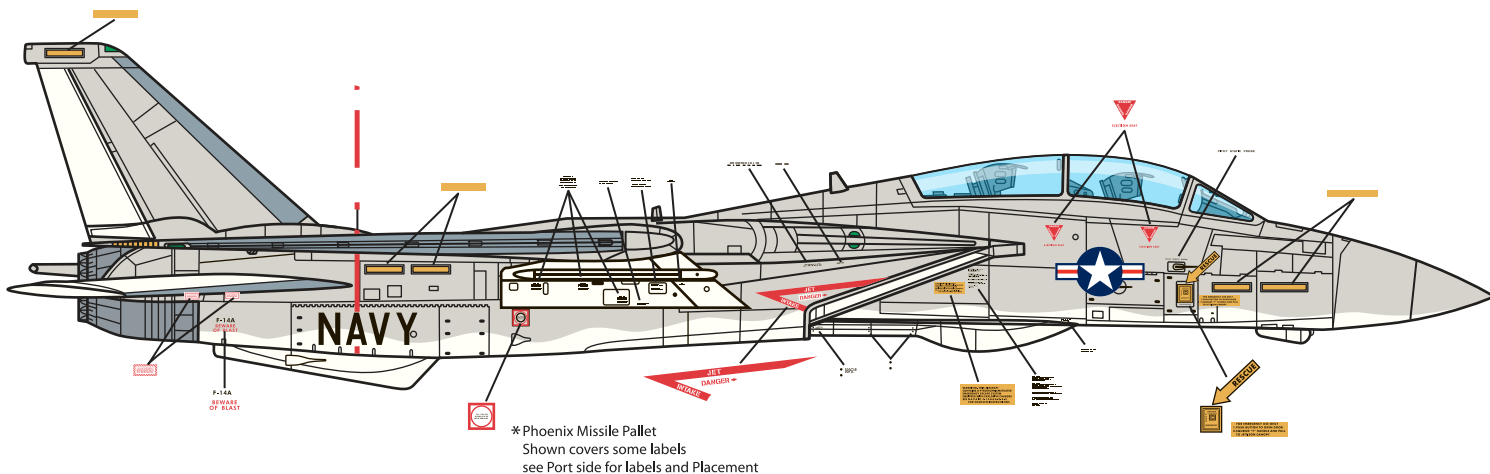

use only if missiles are not installed

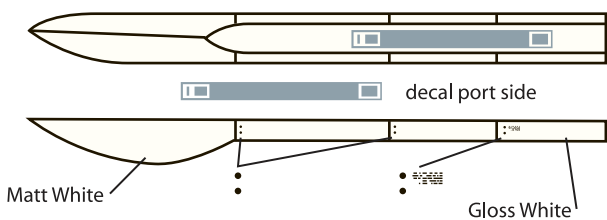

Sidewinder AIM-9G/H
Overall Gloss White FS 17875
Forward Fins and Head-Gloss Black FS 17038



Sparrow AIM-7E
Overall Gloss White FS 17875
Nose Matt Off White FS 37855

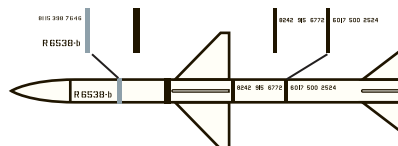

GENERAL PAINTING NOTES:

Cockpit Interior: Dark Green FS 36231
This includes floor, bulkheads, side panels, instrument panels, seat frame and canopy inside bracing.

Ejection Seat:
Dark Gull Gray FS 36231: Seat frame,
Dark Green FS 34079: Parachute rack and seat cushion.
Black: FS 17038: Headrest and seat rails.
Yellow FS 33538: Face curtain handles
(Note-face curtain handles have black stripes)

Wheel Wells, Door Insides and Wheel Struts:
Gloss White FS 27875: Interior of wheel wells, inside of gear doors, wheel struts, wheel hubs, interior of engine intakes access panels.

Gloss Insignia Red FS 31136: Edges on all landing gear doors.
Natural Metal: Oleo struts, lips on intakes and panel in front.

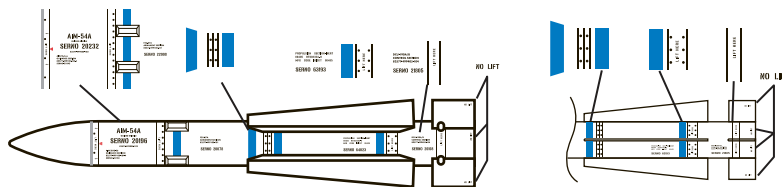

Phoenix AIM-54A
Overall Gloss White FS 17875
Nose Matt Off White FS 37855

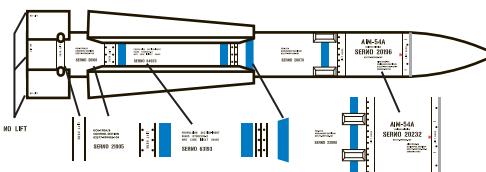

NOTE- Stenciling is always placed on missiles to be readable when missile is mounted on aircraft

AC72-0039
AC48-0039

Microscale Decals F-14 Tomcat Data with unarmed missile markings

Yellow "NO STEP" are used on white control surfaces
While Black "NO STEP" are used on control surfaces of overall gray aircraft.

Markings apply to both sides of aircraft except where noted.

Walkway this side only
FS 36231 Dk. Gull Gray.

Natural Metal leading edge's on Wing, Tail and horizontal stabilizers.

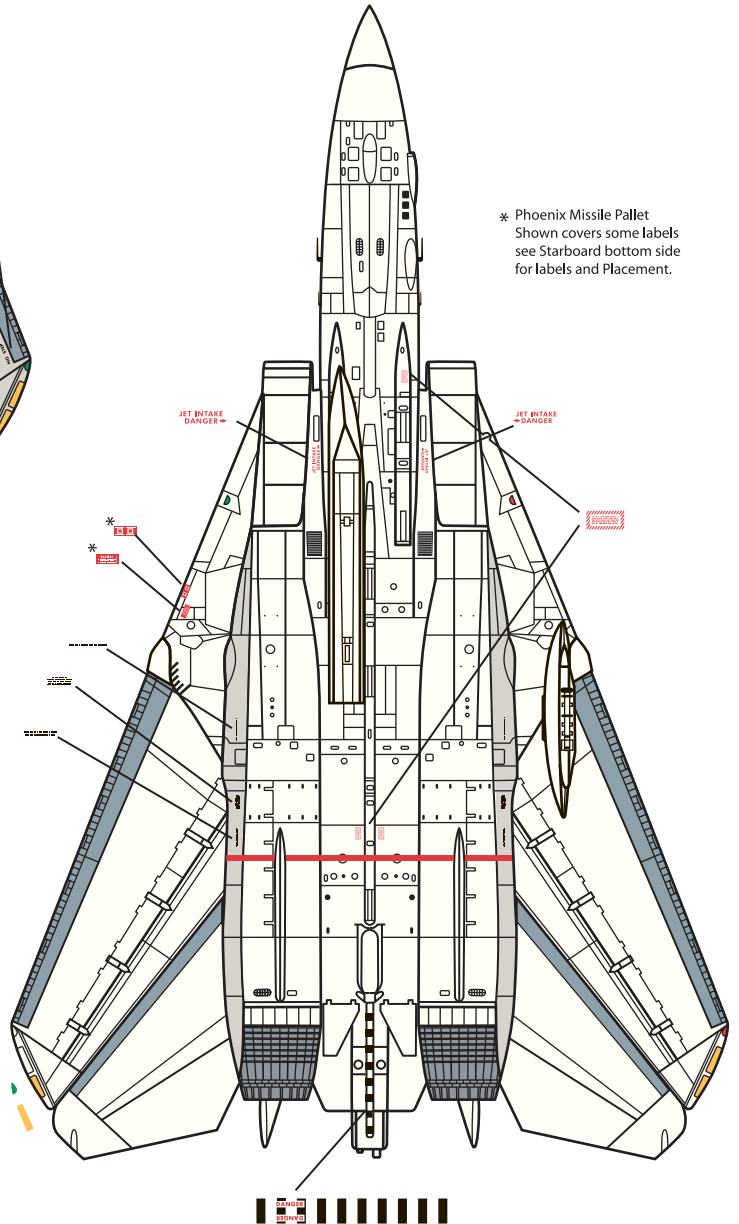
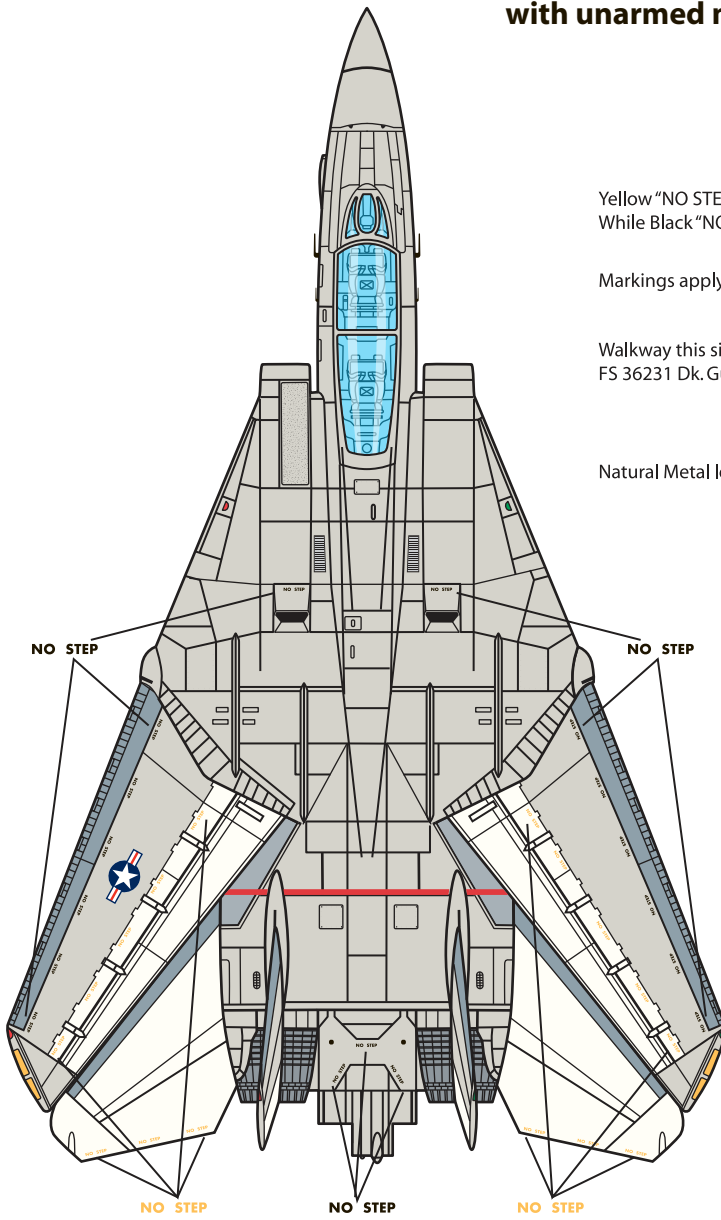

* Phoenix Missile Pallet
Shown covers some labels
see Starboard bottom side
for labels and Placement.

PLACE ONE ON INSIDE OF JET INTAKE
:NOTE PORT SIDE INTAKE IS SHOWN

