

**MATCHBOX**

1-72nd  
SCALE  
KIT

**F4U-4 CORSAIR**

**PK-14**

This plane originated in a U.S. Navy design contest for a Shipboard Single Seat Fighter in early 1938. The Corsair's designers aimed at building the fastest fighter in the world.

Based on the Pratt & Whitney Double Wasp engine, the V166 B design was approved, and a prototype built which was ready in early 1939.

The immense power of the engines required that an enormous airscrew be used, and the inverted gull wing gave adequate ground clearance while keeping the undercarriage length to a minimum.

The Royal Navy were the first to operate the machine from carriers and U.S. Marine Squadrons used the Corsair from ground bases.

Details: Span 40' 11 $\frac{1}{2}$ " . Length 33' 8 $\frac{1}{2}$ "  
Engine: R-2800-18W of 2450 HP.  
Speed: Up to 446 MPH.  
Armament: 6 .50 machine guns.

**ASSEMBLY** MONTAGE  
MONTAGE  
MONTAGGIO  
MONTAJE

"MATCHBOX" IS THE UK'S TRADE MARK (MARC REGISTRADO) OF LESNEY PRODUCTS S & CO. LTD. LONDON, ENGLAND.

Paint required parts before assembly. Assemble parts in sequence. Black numbers in circle indicate part number. Black numbers in star indicate completed section.

Peindre les pièces comme vous le désirez avant le montage. Monter les pièces dans l'ordre numérique. Les chiffres noirs encadrés indiquent le numéro de la pièce. Les chiffres noirs en étoile indiquent une section complète.

Die erforderlichen Teile vor dem Zusammenbau streichen. Die Teile in der richtigen Reihenfolge montieren. Die schwarzen Ziffern in den Kreisen sind die Teilnummern. Die schwarzen Ziffern in den Sternen zeigen komplette Baugruppen an.

Dipingere i pezzi occorrenti prima del montaggio. Montare i pezzi in ordine numerico. I numeri neri in un cerchio indicano il numero del pezzo. I numeri neri in una stella indicano una sezione completa.

Pintar las piezas requeridas antes del montaje. Montar las piezas en secuencia numérica. Los números negros en un círculo indican el número de pieza. Los números negros en una estrella indican una sección completa.

**1**

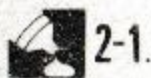

Assemble parts in sequence shown. Assembler par collage les différentes parties selon l'ordre indiqué. Teile in der angegebenen Reihenfolge zusammenkleben. Montare i pezzi nell'ordine indicato. Unir las piezas en la secuencia indicada.

Before joining fuselage halves clear holes 'A' (when shown).

Avant de joindre les deux moitiés du fuselage, dégager les trous 'A' (quand ils sont indiqués).

Vor Zusammensetzung der Rumpfhälften, Locher 'A' säubern (falls gezeigt).

Prima di congiungere le due metà della fusoliera, pulite i buchi 'A' (quando sono indicati).

Antes de unir las dos mitades del fuselaje, despeje las cavidades 'A' (cuando están indicadas).

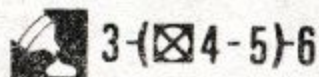
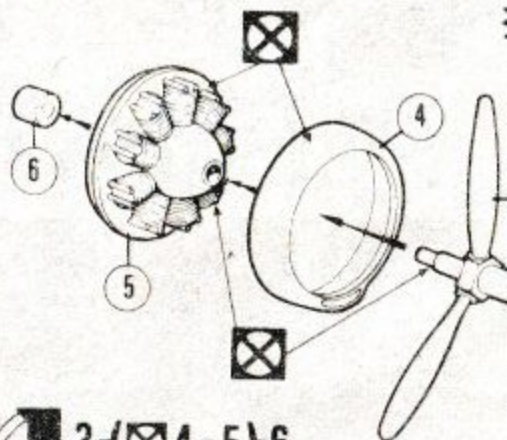

**CEMENT PARTS TOGETHER**  
COLLER ENSEMBLE LES PIÈCES  
TEILE ZUSAMMENKLEBEN  
ATTACCARE I PEZZI CON ADESIVO  
UNIR LAS PIEZAS CON ADHESIVO



**DO NOT CEMENT TOGETHER**  
NE PAS COLLER ENSEMBLE  
NICHT ZUSAMMENKLEBEN  
NON ATTACCARE CON ADESIVO  
NO UNIR LAS PIEZAS CON ADHESIVO



**ALTERNATIVE PART PROVIDED**  
PIECE ALTERNANT FOURNIE  
WAHLWEISE MIT ANDEREM TEIL  
PEZZO ALTERNATIVO  
PIEZA ALTERNATIVA PROVISTA



**WITHOUT STAND, ADD NOSE WEIGHT.**  
S'IL N'Y A PAS DE SUPPORT, IL FAUT ALOURDIR LE NEZ.  
OHNE STAND, FLUGZEUGKANZEL BESCHWEREN.  
SE NON VI È UN SUPPORTO, OCCORRE APPESANTIRE IL NASO.  
DE NO IR SOBRE UN SOPORTE EXHIBIDOR, DEBE AÑADIRSE PESO AL MORRO.

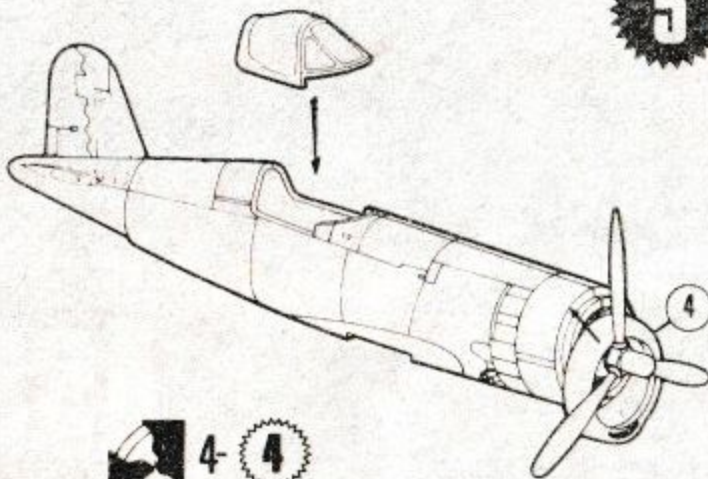

**5**

**6**

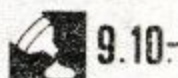
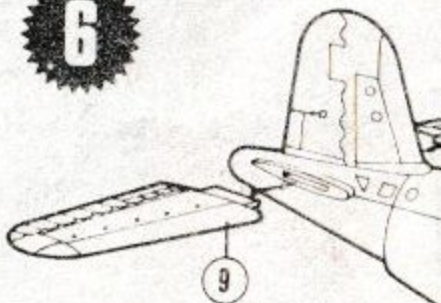

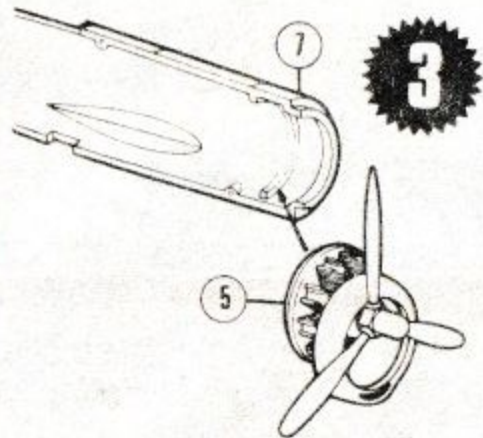
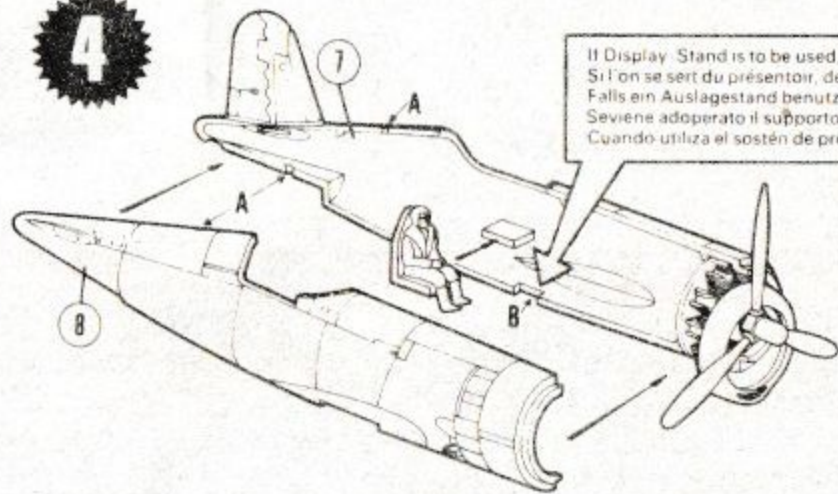
**2****3****4**

If Display Stand is to be used, clear slots **B**.  
 Si l'on se sert du présentoir, dégager les fentes **B**.  
 Falls ein Auslagestand benutzt wird, Kerbe **B** klären.  
 Se viene adoperato il supporto di presentazione, pulire le fessure **B**.  
 Cuando utiliza el sostén de presentación, despeje las ranuras **B**.

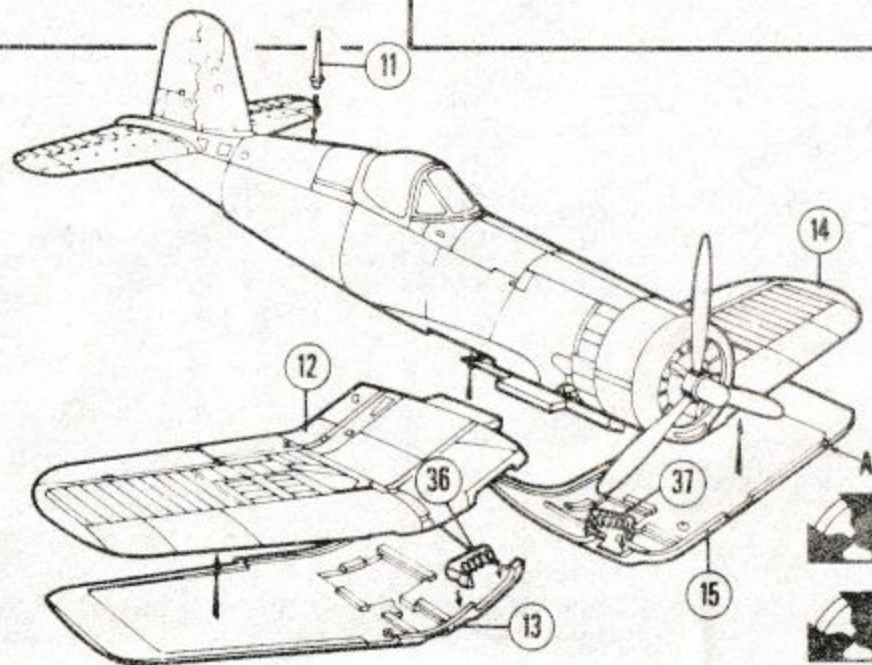
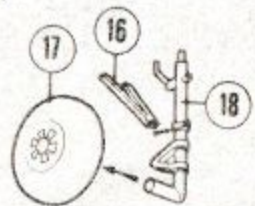

5-7

**1**-7-8**5****7****8**

16-18-17.



19-21-20.



11.



36-13-12. 37-15-14.

9

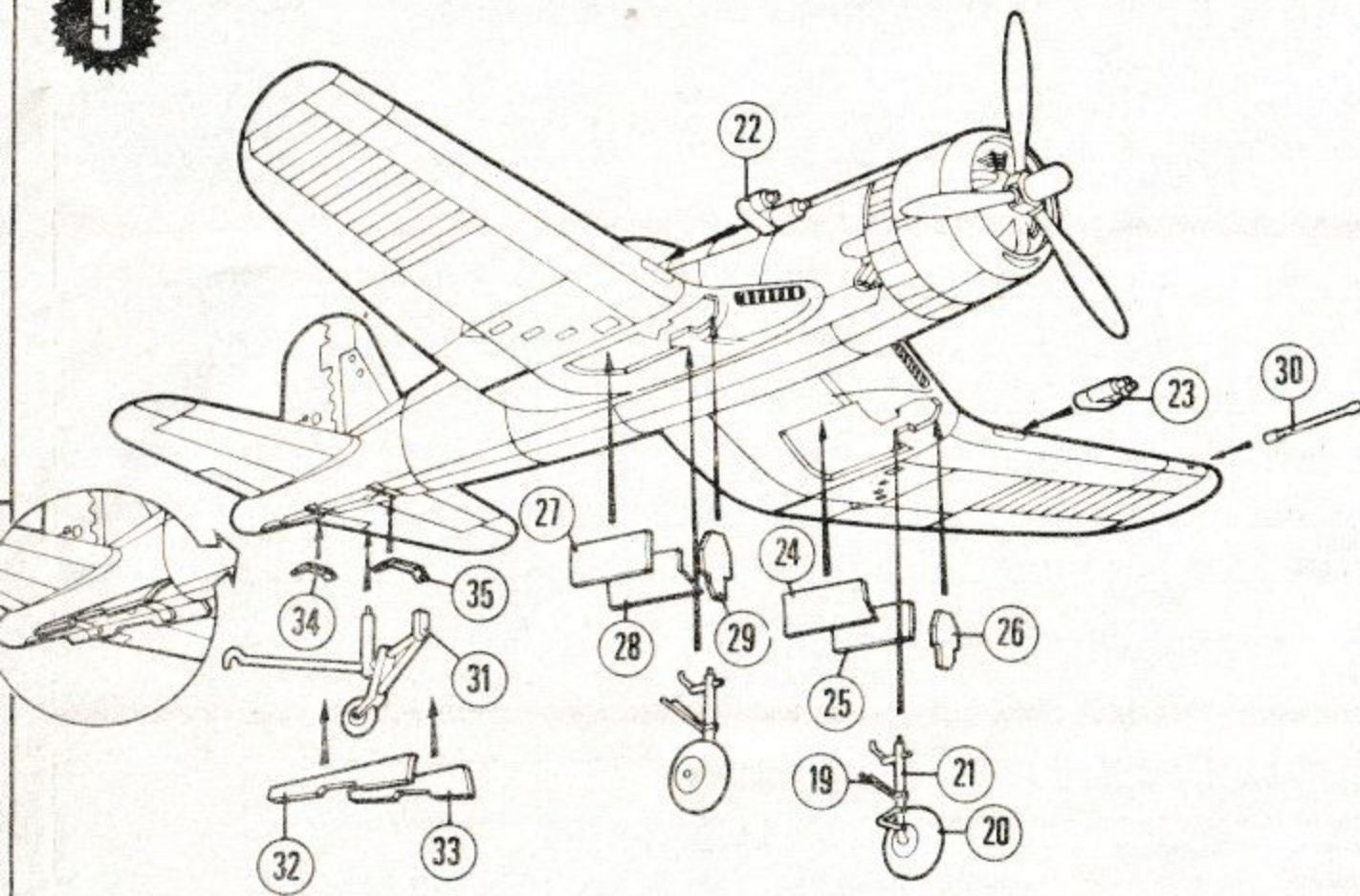

Purple Range. 1/72nd Scale Aircraft

- PK-1 HAWKER FURY
- PK-2 SPITFIRE Mk IX
- PK-3 BOEING P-12E
- PK-4 MITSUBISHI ZERO
- PK-5 ALPHA JET
- PK-6 FW 190
- PK-7 LYSANDER
- PK-8 GLOSTER GLADIATOR
- PK-9 BELL HUEY-COBRA
- PK-10 B A C. STRIKEMASTER
- PK-11 HAWKER HURRICANE
- PK-12 NORTHROP P5-A
- PK-13 MUSTANG P51-D
- PK-14 CORSAIR F4U-4
- PK-15 GNAT T. Mk I
- PK-16 HAWKER HARRIER
- PK-17 ME/BF 109E
- PK-18 GRUMMAN HELLCAT
- PK-19 MIKOYAN MIG-21
- PK-20 DASSAULT MIRAGE IIC
- PK-21 ME 262
- PK-22 P47-D THUNDERBOLT
- PK-23 TEMPEST Mk VI/Mk II
- PK-24 BREWSTER BUFFALO
- PK-25 SISKIN
- PK-26 HENSCHEL HE 126

Purple Range. 1/76th Scale Military Vehicles

- PK-71 SHERMAN FIREFLY
- PK-72 A-34 COMET Mk I
- PK-73 Ausf G. PANTHER
- PK-74 PANZER III Ausf L
- PK-75 HUMBER Mk II
- PK-76 PUMA
- PK-77 WESPE
- PK-78 M 16 HALF TRACK
- PK-79 M 24 CHAFFEE
- PK-80 Jagd. PANTHER

Orange Range. 1/72nd Scale Aircraft

- PK-101 CORSAIR A7-D
- PK-102 BAC 'S' JAGUAR
- PK-103 BEAUFIGHTER Mk X
- PK-104 SB 2C-1 HELLDIVER
- PK-105 WALRUS Mk I
- PK-106 BUCCANEER SB2
- PK-107 DORNIER SKYSERVANT
- PK-108 WESTLAND LYNX
- PK-109 JUNKERS JU 188 F.1
- PK-110 HS 125/600

22.23. 26.29. 7 24.25.27.28. 30. 34.35.31.32.33 - 6

**PK-14**

RETURN TO (UK ONLY)  
 CONSUMER SERVICE DEPT.  
 LESNEY PRODUCTS & CO. LTD.  
 SWAINS INDUSTRIAL ESTATE,  
 ASHINGTON ROAD,  
 ROCHFORD, ESSEX, ENGLAND

**PAINT INSTRUCTIONS**

The CODE LETTERS (a b c etc.) shown on the Colour-plan and Mini-Paint plans indicate the correct paint colour from the Humbrol Authentic range. (See list below).

**INSTRUCTIONS POUR LA PEINTURE**

Les LETTRES a) b) c) etc. figurant sur le schéma et le mini-schema de couleurs indiquent les couleurs exactes à choisir de la gamme Humbrol Authentic (voir liste ci-dessous).

**MALANWEISUNGEN**

Die SCHLUSSELBUCHSTABEN (a b c usw.) auf den Farb- und Mini-Farbplan weisen auf die richtigen Malfarben aus der Humbrol Authentic Auswahl hin. (siehe untere Liste).

**ISTRUZIONI PER I COLORI**

Le LETTRE a) b) c) ecc. sullo schema ed il mini-schema di colori indicano i colori esatti da scegliere dalla gamma Humbrol Authentic. (Vedi elenco qui appresso).

**INSTRUCCIONES PARA LA PINTURA**

Las LETRAS DE CLAVE (a.b.c. etc.) que se muestran en los planos de Colores y de Mini-Pintura indican el color correcto de pintura de la gama Humbrol Authentic. (Véase la lista a continuación).

<b>a</b>	HB 9 SEA BLUE GLOSS	HB 9 BLEU DE MER BRILLANT	HB 9 GLANZSEEBLAU	HB 9 BLUE MARE LUCENTE	HB 9 AZUL DE MAR BRILLO
<b>b</b>	22/G3 WHITE	22/G3 BLANC	22/G3 WEISS	22/G3 BIANCO	22/G3 BLANCO
<b>c</b>	HU.12 NIGHT BLACK	HU.12 NOIR NUIT	HU.12 NACHTSCHWARZ	HU.12 NERISSIMO	HU.12 NEGRO NOCHE
<b>d</b>	HT 6 INSIGNIA YELLOW	HT.6 JAUNE INSIGNE	HT.6 ABZEICHENGELB	HT.6 GIALLO INSEGNA	HT.6 AMARILLO INSIGNIAS
<b>e</b>	HB.14 AIRFRAME SILVER	HB.14 GRIS FUSELAGE	HB.14 FLUGWERK-SILBER	HB.14 GRIGIO FUSOLIERA	HB.14 PLATA FUSELAJE
<b>f</b>	HX.5 LIGHT AIRCRAFT GREY	HX.5 GRIS AVION CLAIR	HX.5 FLIEGERGRAU	HX.5 GRIGIO AEREO CHIARO	HX.5 GRIS DE AVION CLARO
<b>g</b>	61/M7 FLESH	61/M7 CHAIR	61/M7 FLEISCHFARBEN	61/M7 CARNE	61/M7 CARNE
<b>h</b>	62/M23 LEATHER	62/M23 CUIR	62/M23 LEDERFARBEN	62/M23 CUOIO	62/M23 CUERO

**Instructions. Waterslide transfers.** Cut transfers from sheet. Place transfers as required onto the surface of clean water for 45 seconds (approx) slide transfer off backing paper into position.

**Instructions pour les décalcomanies** Découper les décalcomanies dans la feuille. Poser les décalcomanies voulues sur de l'eau propre pendant 45 secondes environ. Les mettre ensuite en position en les faisant glisser de sur le papier de renfort.

**Gebrauchsanweisung - Wassergleit-Abziehbilder** Abziehbilder aus dem Bogen schneiden. Die gewünschten Abziehbilder ungefähr 45 Sekunden lang auf eine saubere Wasseroberfläche legen. Abziehbild vom Papier in die richtige Lage schieben.

**Istruzioni per le decalcomanie** Ritagliate le decalcomanie dal foglio. Ponete quelle occorrenti su dell'acqua pulita per circa 45 secondi. Mettetele poi in posizione facendole scivolare dalla carta di rinforzo.

**Instrucciones - Calcomanías de agua** Cortense las calcomanías de la hoja. Ponganse como se desea sobre la superficie de agua limpia por 45 segundos (aproximadamente) desprendase la calcomanía del papel de respaldo en posición.



MY COMPLAINT IS  
 L'OBJET DE MA RECLAMATION EST  
 ICH BEMÄNGELE  
 DASS OGGETTO DEL RECLAMO  
 MI RECLAMACION ES  
 MY ADDRESS  
 MON ADRESSE EST LA SUIVANTE  
 MEINE ADRESSE  
 IL MIO INDIRIZZO  
 MI DIRECCION

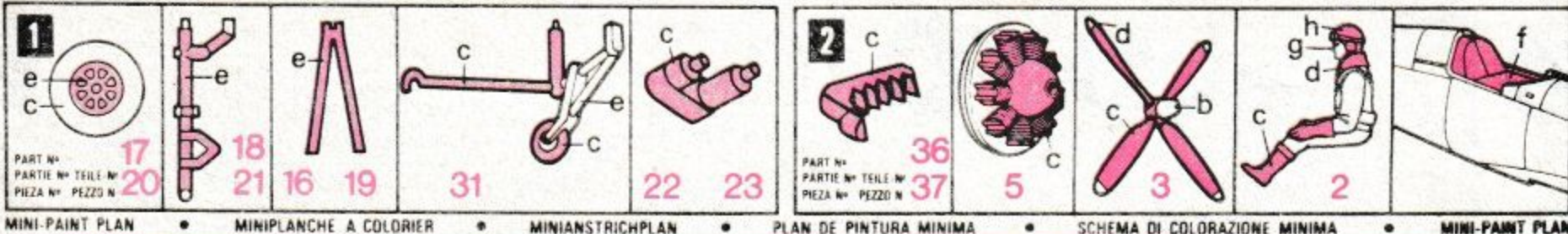

**1** C'est à l'occasion d'un concours de projets ayant eu lieu au début de 1938 et organisé par la Marine américaine pour un chasseur monoplace embarqué que les dessinateurs du Corsair se fixèrent pour but de construire le chasseur le plus rapide du monde.

S'inspirant du Pratt & Whitney Double Wasp, le projet V166B fut accepté et le prototype était prêt au début de 1939.

La puissance considérable des moteurs demandait que l'hélice soit très grande, et l'aile en M inversée permettait une hauteur libre appropriée tout en conservant au train d'atterrissage une longueur minimum.

La Navy fut la première à utiliser cet avion sur des porte-avions et les escadrilles américaines l'employèrent à partir de bases terrestres.

**2** Tuvo su origen en un concurso de proyectos de la Marina de los EE.UU., a principios de 1938, para un caza monoplaça para portaviones. Los proyecticistas del Corsair aspiraban a construir el avión de caza más rápido del mundo.

Basado en el motor Double Wasp de Pratt & Whitney, se aprobó el proyecto del V166B, y, a principios de 1939, se terminó la construcción de un prototipo de avión.

La extraordinaria potencia de los motores hizo necesario el uso de una enorme hélice y las alas de gaviota invertidas ofrecían un adecuado despeje sobre el suelo, a la vez que conservaban al mínimo la longitud del tren de aterrizaje.

**3** Bei der Corsair, die aus einem Konstruktionswettbewerb der amerikanischen Marine für einen einsitzigen, für Flugzeugträger verwendbaren Jäger zu Beginn des Jahres 1938 hervorgegangen war, hatten sich die Konstrukteure das Ziel gesetzt, das schnellste Jagdflugzeug der Welt zu bauen.

Der auf der Pratt & Whitney Double Wasp basierende Type V166B angenommen, und es wurde ein Prototyp gebaut, der zu Beginn des Jahres 1939 fertig war.

Die hohe Leistung der Motoren machte eine riesige Luftschraube erforderlich, und die abgeknickten Möwenflügel ergeben genügend Bodenfreiheit, während die Fahrwerkklänge auf ein Minimum beschränkt blieb.

**4** L'origine di questo apparecchio risale ad un concorso di progettazione bandito dalla Marina Militare degli Stati Uniti al principio del 1938 per un caccia monoposto per portaerei. I progettisti del Corsair mirarono a costruire il più veloce caccia del mondo. Basato sul motor Double Wasp della Pratt & Whitney, il disegno del V166B venne approvato, ed un prototipo venne costruito ed approntato all'inizio del 1939. L'enorme potenza del motore impose l'uso di una grandissima elica, mentre le ali a forma di gabbiano invertito permettevano un'adeguata altezza da terra pur con un carrello d'atterraggio relativamente basso. La Marina Militare Britannica fu la prima ad operare l'apparecchio da portaerei e la Squadre di Compagnie di Sbarco americane l'usarono da basi terrestri.

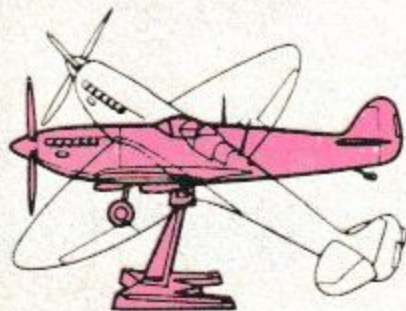

**MULTI-POSITION DISPLAY STAND**  
**PIED PERMETTANT DE MULTIPLES POSITIONS**  
**EINSTELLHALTER**  
**SOPORTE DE POSICIONES MULTIPLES PARA EXPOSICION**  
**SUPPORTO A TESTA SNODABILE**

Push socket-head onto ball.  
 Insérer la sphère dans la cavité.  
 Die Pfanne auf die Kugel pressen.  
 Empujar el casquillo esférico sobre la bola.  
 Innestare la sfera nella testa a snodo



Cement arm to base.  
 Coller le bras au piétement.  
 Den Arm unten festkleben.  
 Unir el brazo a la base con adhesivo.  
 Attaccare il braccio alla base con adesivo.





**1** USA Marine Training Sqd.  
VMFT. 20 Aircraft No. 14.



COLOUR PLAN  
PLANCHE EN COULEURS  
FARBPLAN  
PLAN DE COLORES  
SCHEMA DEI COLORI



**2** US Marine Sqd. VMF 211  
Aircraft No. 8.

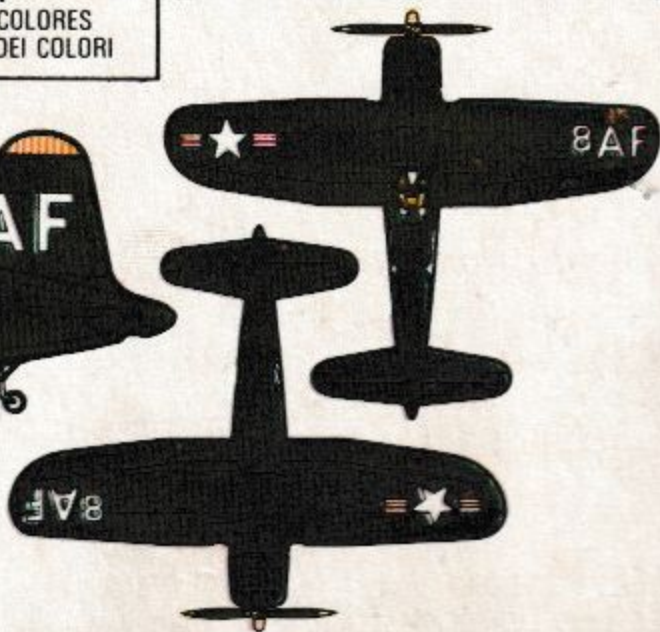

This "CORSAIR" kit is quality engineered in two colours. Decals feature the U.S. Marine Training Sqd. VMFT-20 or Marine Squadron VMF-211 versions of this famous carrier aircraft. A full "Colour-Plan" and easier Mini-Paint plan are provided. For paint colours, see instruction leaflet.



A92

CONTENTS: Parts and decals necessary to construct model as illustrated. Cement not included.  
SPECIFICATION AND COLOUR OF CONTENTS SUBJECT TO AMENDMENTS