

EAGLE STRIKE

48239



STARFIGHTERS 1

F-104C and F-104G Starfighters

our thanks to
THE AVIATION WORKSHOP
for their co-operation
in producing these decals.

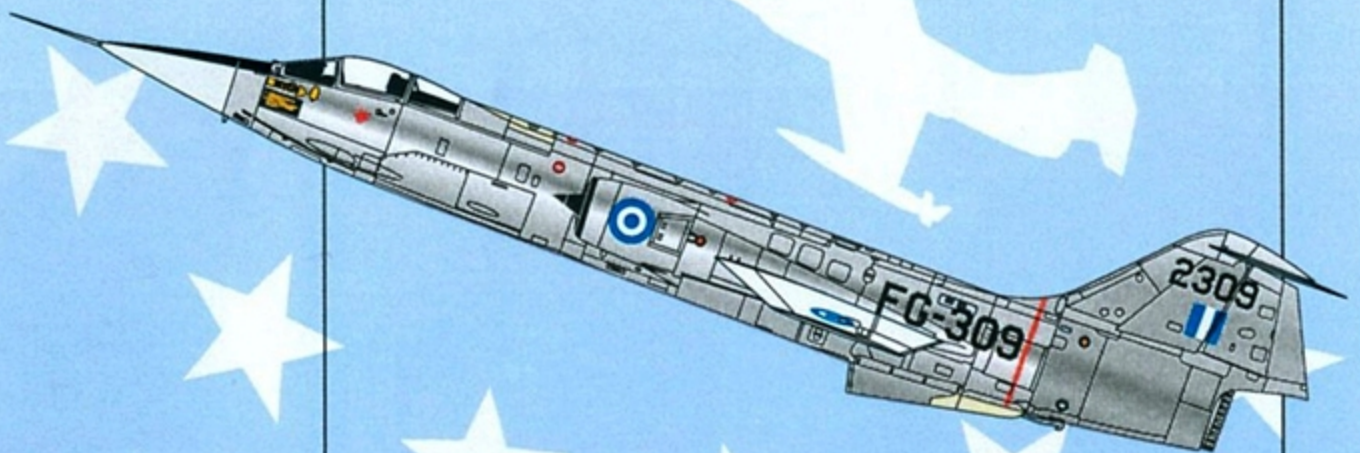
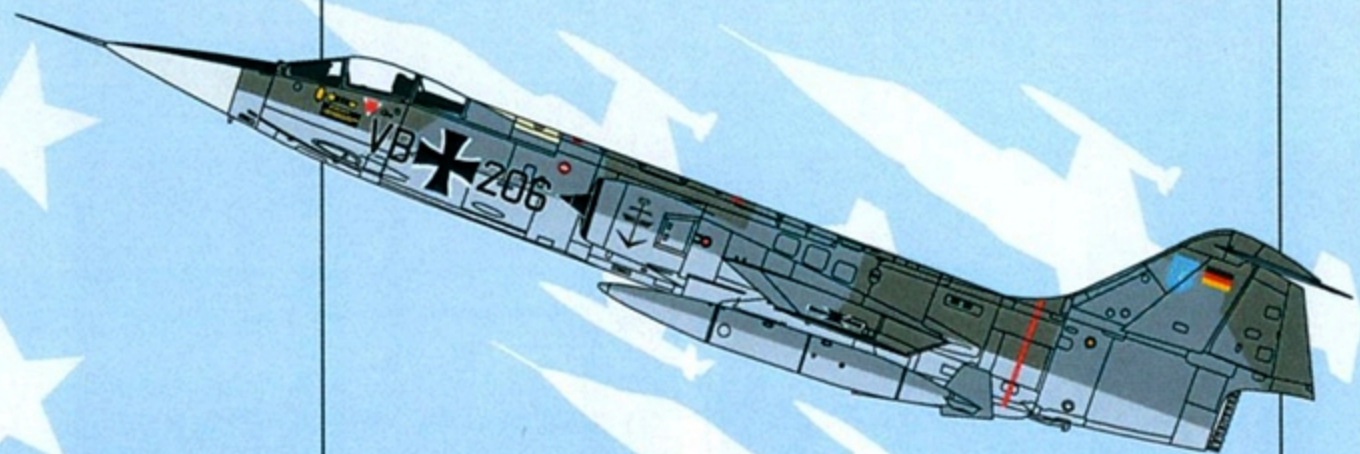
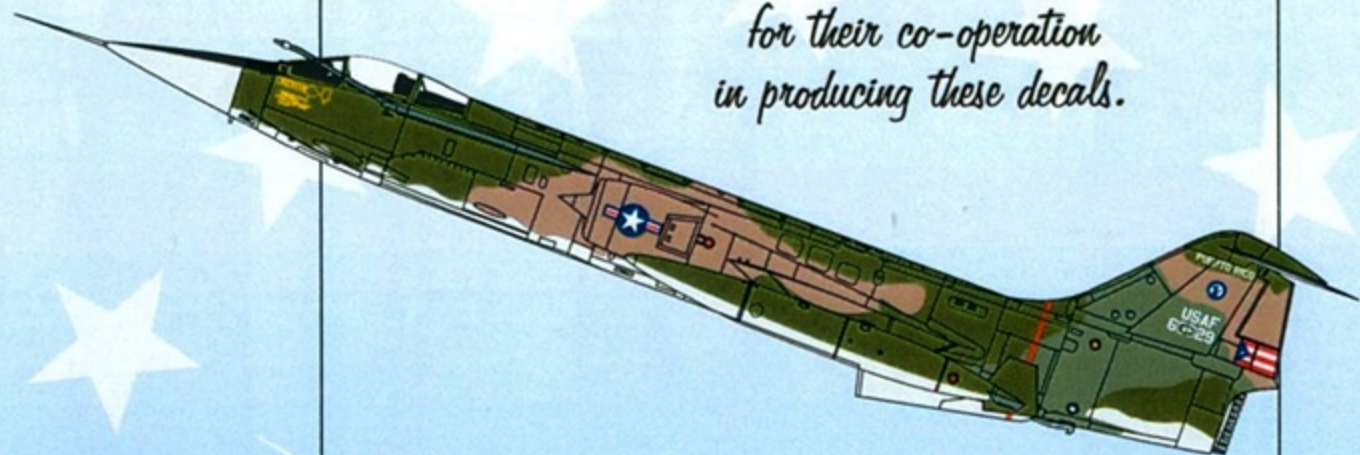

Suggested Kit: - Hasegawa F-104G Starfighter

STARFIGHTERS 1

F-104C and F-104G Starfighters

Lockheed F-104C Starfighter 56-929
 198th. Tactical Fighter Squadron,
 Puerto Rico Air National Guard
 Muniz Air Force Base, San Juan,
 Puerto Rico 1967

US SEAC scheme of Dark Green FS34079,
 Medium Green FS34102 and Tan FS30219 over
 Pale Grey FS36622



Lockheed RF-104G Starfighter 4391
 12th. Tactical Reconnaissance
 Squadron, 5th. Tactical Fighter
 Wing, Taiwanese Air Force, Hualien,
 Taiwan, 1990.

Lo-viz scheme of overall Gray
 FS36375 with Medium Gray
 F36320 patches on upper
 surfaces

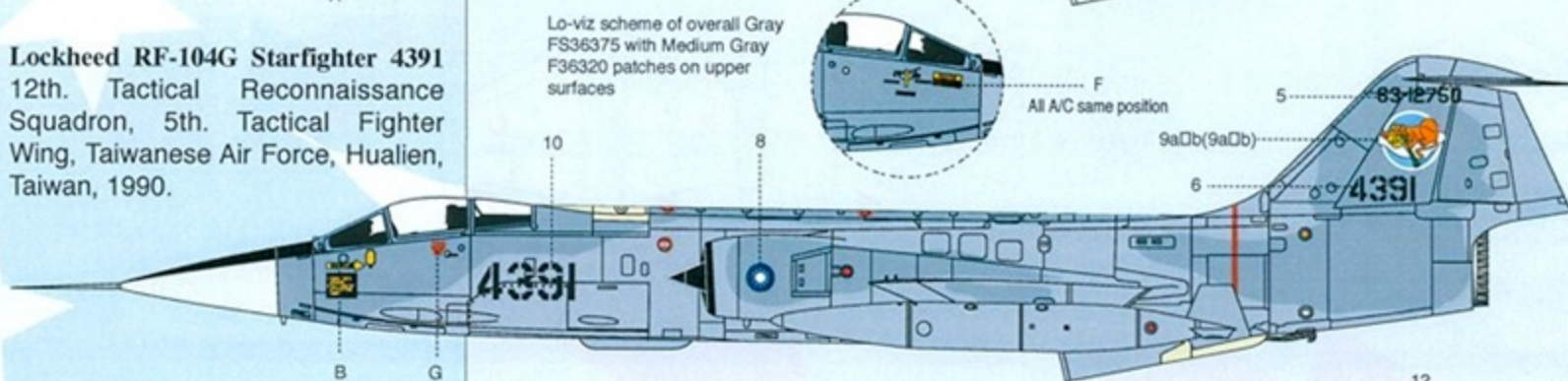

Lockheed F-104G Starfighter VB+206
 Marinefliegergeschwader 2 (MFG2),
 Bundesmarine, Eggebek, Federal
 German Republic, 1964.

Splinter camouflage scheme of RAL7012
 Basaltgrau and RAL6014 Gelboliv upper surfaces
 over RAL 7001 Silbergrau undersurfaces.

Positioning of codes and insignia on
 starboard side

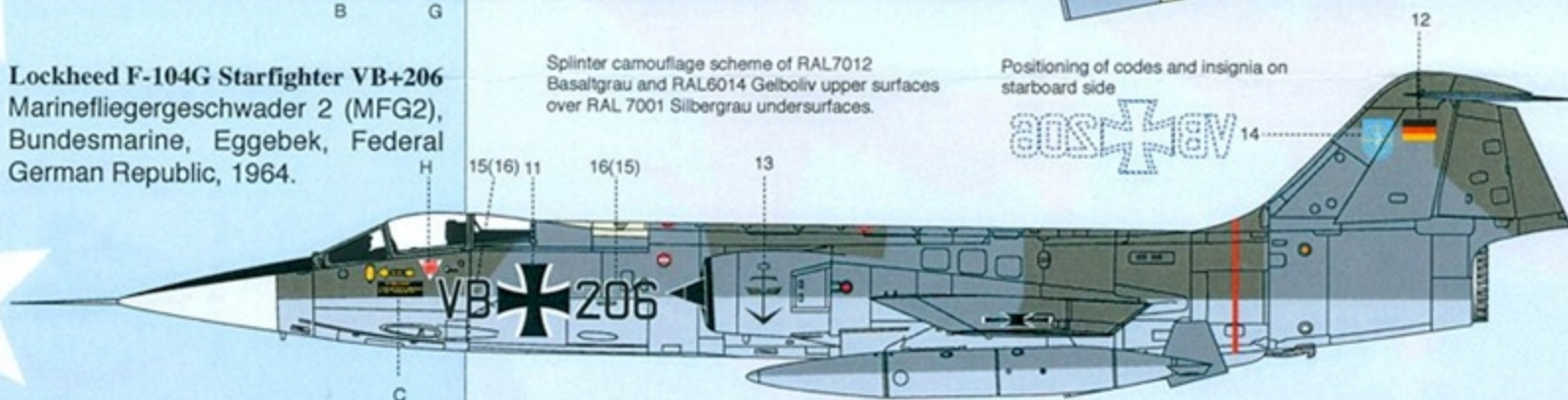

Lockheed F-104G Starfighter 62-12309
 FG-309 335 Mira, Hellenic
 Air Force, Tanagra, Greece 1964.

Natural metal finish with Gloss White upper wing surfaces and
 Anti-corrosion Gray FS16473 under surfaces

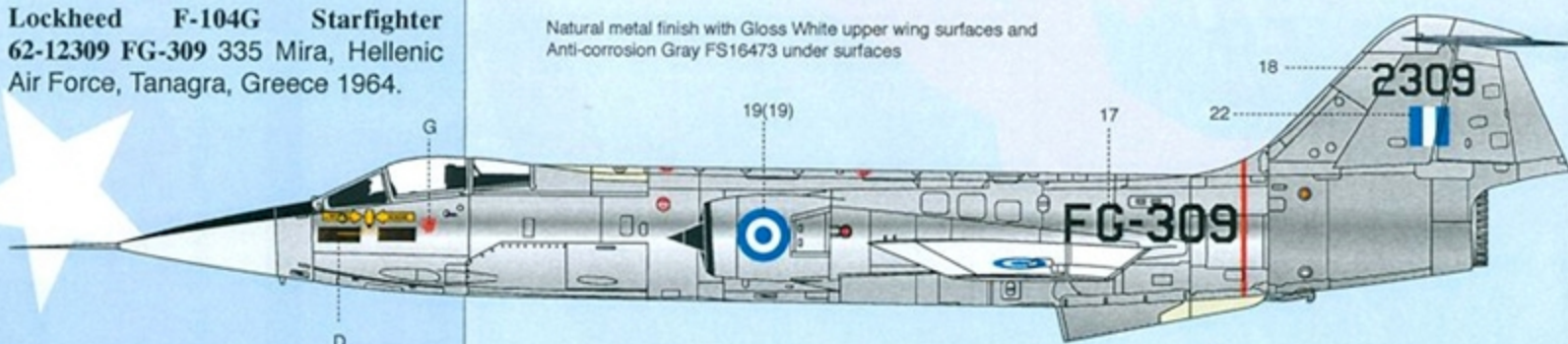

Lockheed F-104G Starfighter R-346
 Esk 723, Royal Danish Air Force,
 Aalborg, Denmark 1966.

Overall Anti-corrosion Gray FS16473 finish with
 Gloss White wing upper surfaces



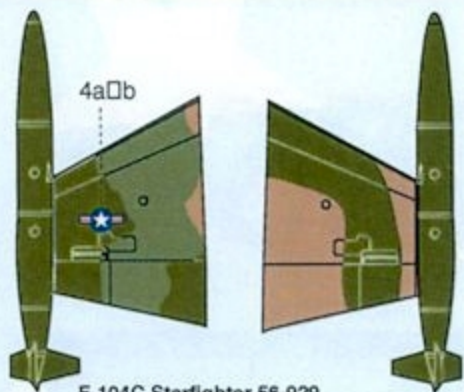

F-104C Starfighter 56-929
Scrap view of wing upper surfaces

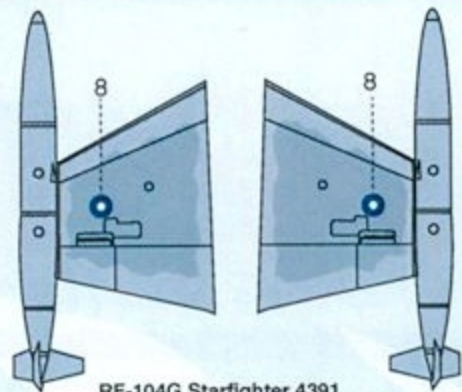

RF-104G Starfighter 4391
Scrap view of wing upper surfaces

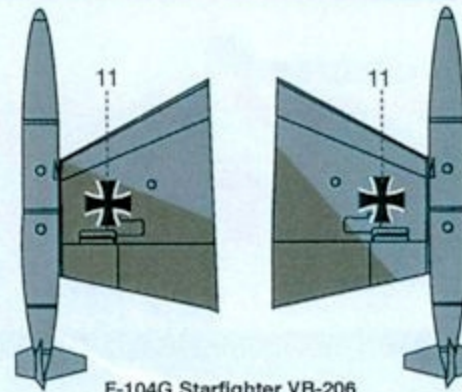

F-104G Starfighter VB-206
Scrap view of wing upper surfaces

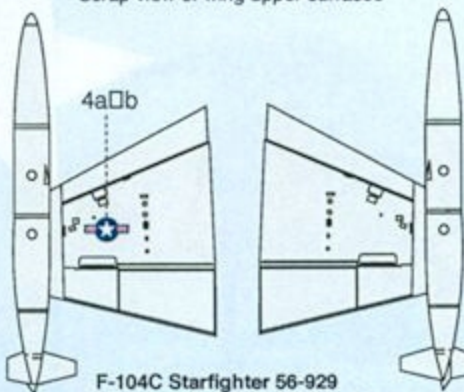

F-104C Starfighter 56-929
Scrap view of wing under surfaces

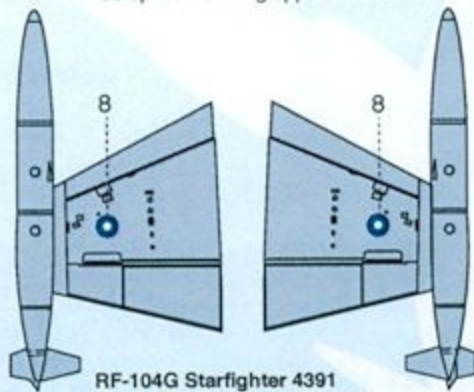

RF-104G Starfighter 4391
Scrap view of wing under surfaces

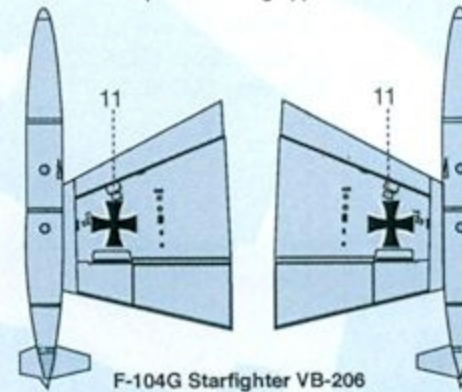

F-104G Starfighter VB-206
Scrap view of wing under surfaces

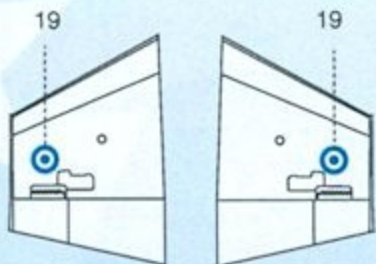

F-104G Starfighter 62-12309 FG-309
Scrap view of wing upper surfaces

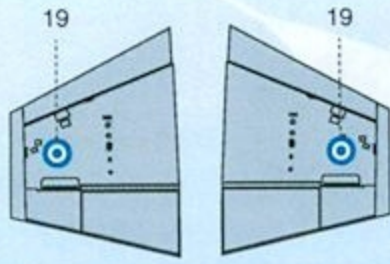

F-104G Starfighter 62-12309 FG-309
Scrap view of wing under surfaces

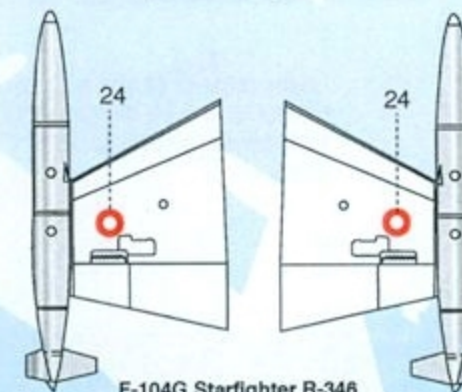

F-104G Starfighter R-346
Scrap view of wing upper surfaces



our thanks to
THE AVIATION WORKSHOP
for their co-operation
in producing these decals.

Recommended Kit
- Hasegawa 1:48 F-104G
Starfighter

References:

1. Lockheed F-104 Starfighter, Jon Freeman, On Target Profiles 1, The Aviation Workshop
 2. Lockheed F-104 Starfighter, Wings of Fame Vol. 2, Aerospace Publishing.
- www.airliners.net www.starfighters.nl

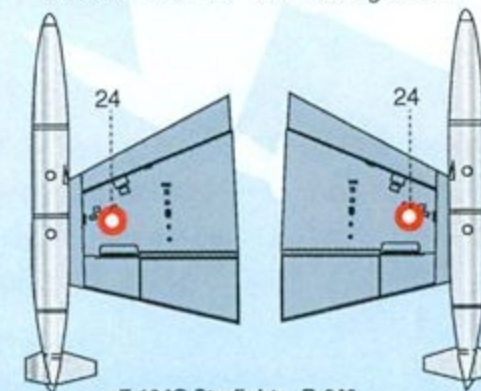

F-104G Starfighter R-346
Scrap view of wing under surfaces



12902 SW 132nd CT. Miami, FL. 33186
U.S.A.
Ph: (786) 293-0411, Fax: (786) 293-5822.

EAGLE STRIKE
Productions