

# Yugoslav Fighters 1938-41

**Fury  
IK-2  
Hurricane  
Bf109E  
IK-3**

Plus Croatian IK-2, G-50, 1941-42

**1/72nd scale**

This package contains four sheets of decals

A NOTE ON THE COLORS: There seems to be a bit of confusion on the proper colors for the Royal Yugoslavian Air Force insignia. The colors of the roundel come from the national flag, which hasn't changed, except for the addition of a red star. The red and the lighter blue were matched to the modern flag. The cross comes from the "Cross of Danilo", a Montenegrin symbol. All contemporary sources show it to be outlined in blue (not black) so a blue noticeably darker than the other was selected.

Copyright 1979

## The Guano Aeroplane & Zeppelin Works

5802 North East 59th Street, Seattle, WA 98105 USA

Fury IA, 6th Puk, 1938  
Bare metal/silver dope overall. Wood prop, bare spinner.

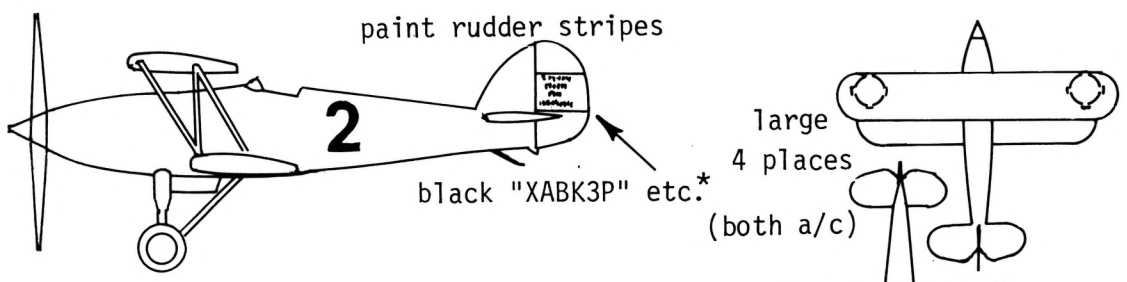

Fury "II", 35th Grupa, 5th Puk, 1941.  
Dk. green, earth brown upper and sides, lt. gray lower. Wood prop, brown spinner.

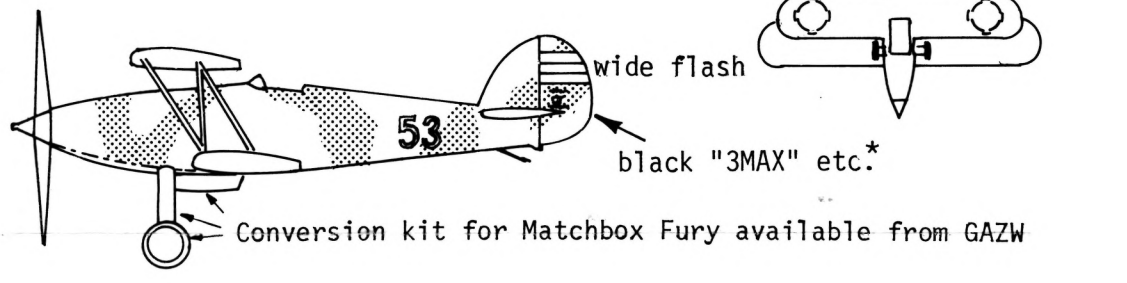

 Dk. green

Hurricane, delivery, 1939,  
Watts prop, fabric wings.  
RAF dk. green, earth brown upper, silver dope lower. Black prop with yellow tips, brown spinner.

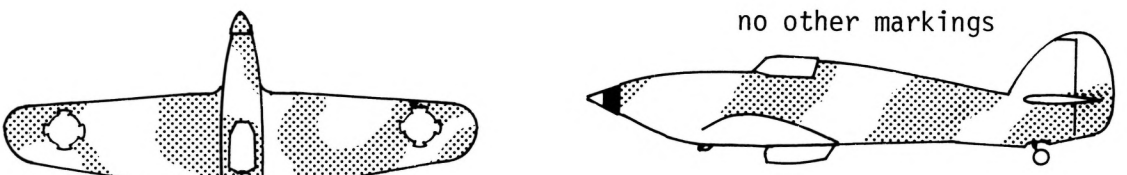

Hurricane, Mostar Fighter School, 1941.  
D.H. type spinner.  
Dk. green, earth brown upper, lt. gray lower, NOT RAF pattern. Dark prop blades, bare metal panel below exhausts.

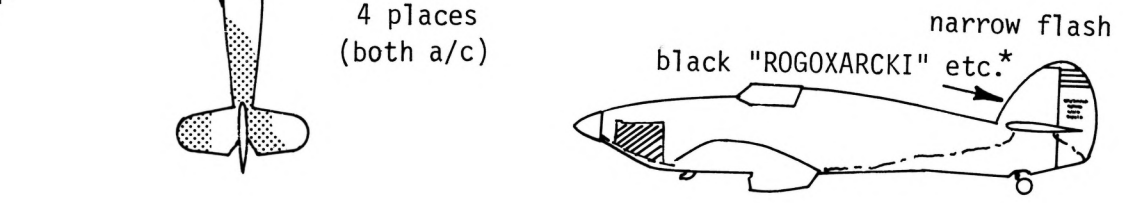

LET DRY!

DIRECTIONS: For RYAF insignia: Apply red/white portion first, When applying blue/blue portion, there will be one alignment (out of the four possible) where the red and blue rings are concentric, and the dark blue outlines the white cross properly. (Additional insignia sheets are available at \$.60 (35p) each.)

NOTES: Where camouflage schemes are not completely shown, there is not enough information to specify them. Complete in the same "style".

Markings shown with a "\*" are conjectured from RYAF standard methods of aircraft designation and marking.

Blue is uppermost on all rudder striping and rudder flashes. Flashes are approximately twice as long as high.

IK-2, 6th Puk, early 1939.  
Bare metal/silver dope overall, black prop blades.

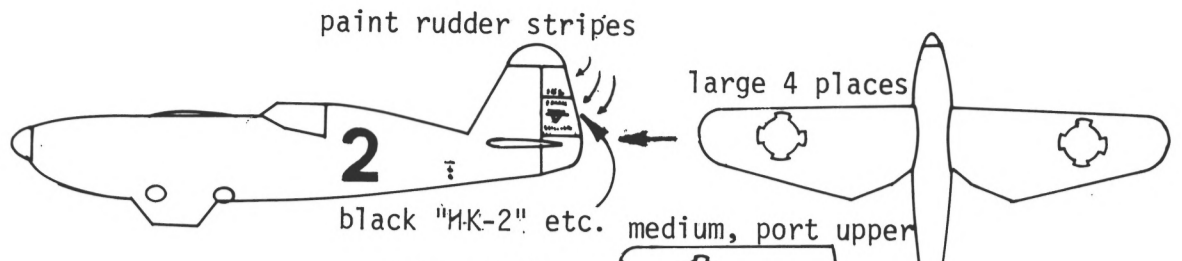

IK-2, 34th Grupa, 4th Puk, 1941.  
Dk. green, earth brown upper; lt. gray lower, inc. struts and prop.

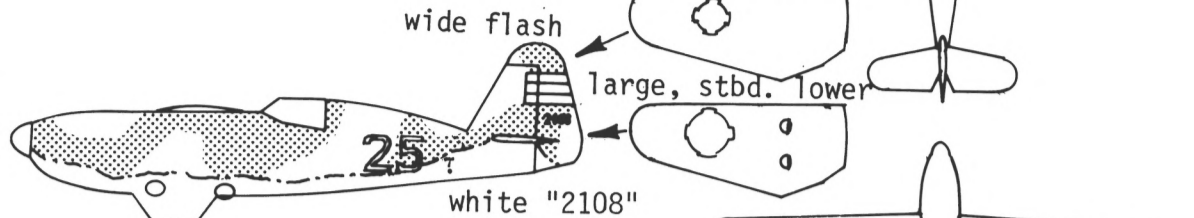

IK-2, Croatian forces, 1942.  
Olive drab upper, lt. gray lower. Spinner olive drab, blades black.

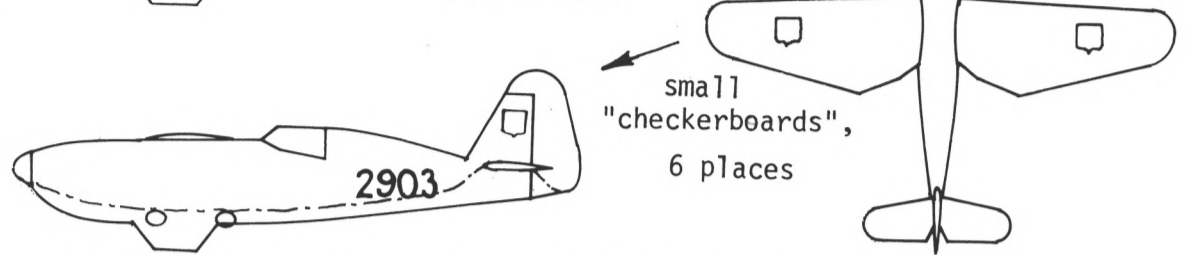

1/72nd injection molded kit available from GAZW

IK-3, 52nd Grupa, 6th Puk, 1941.  
Dk. green, earth brown upper, lt. gray lower. Dark prop blades

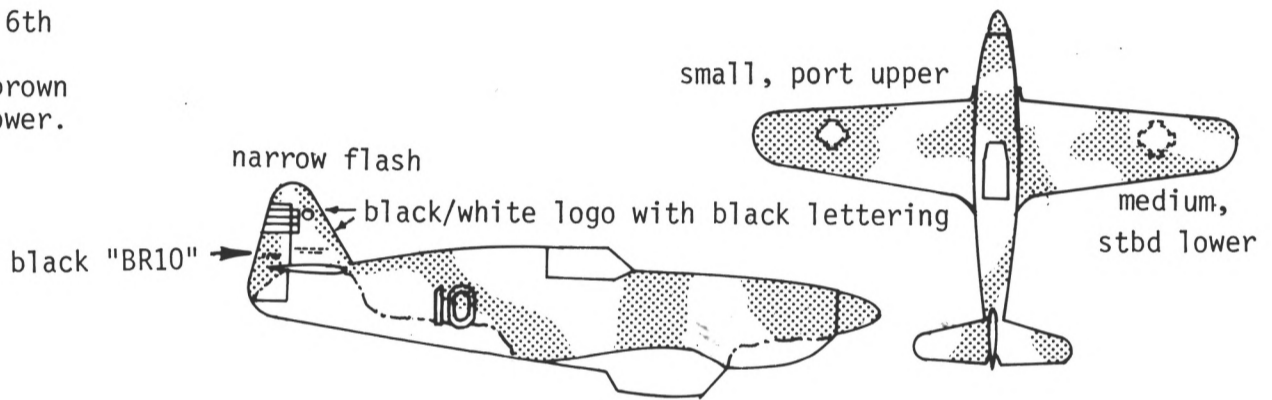

Bf109E-3, 32nd Grupa, 6th Puk, 1940.  
Very dark green (70) upper, lt. blue (65) lower. Black spinner.

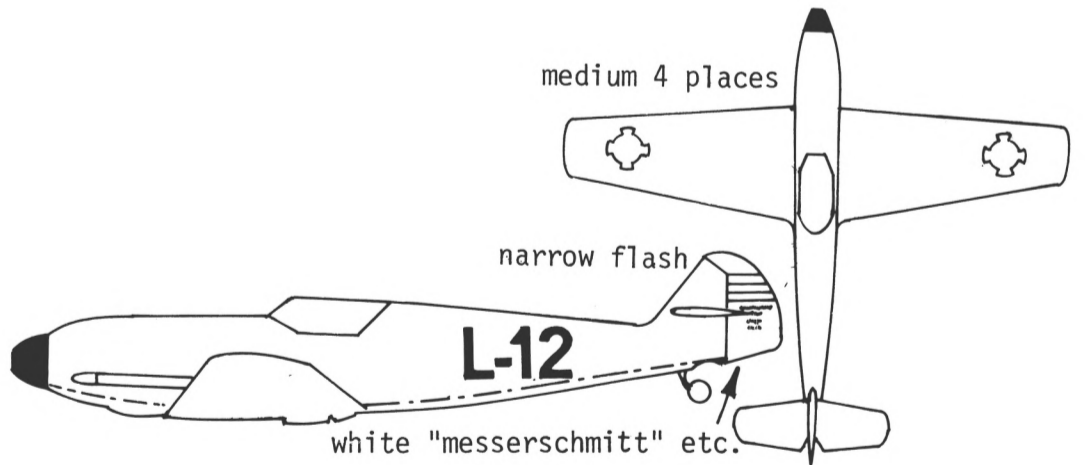

References: Air Enthusiast, Vol. I, No. 4&5; Air Enthusiast Quarterly, No. 3; Profiles (aircraft) No. 111, 188, & 242

Fiat G-50bis, Croatian forces, summer, 1941.  
Dark green upper surfaces, light grey lower. Yellow fuselage band, cowl ring, and wingtip undersides. White spinner.

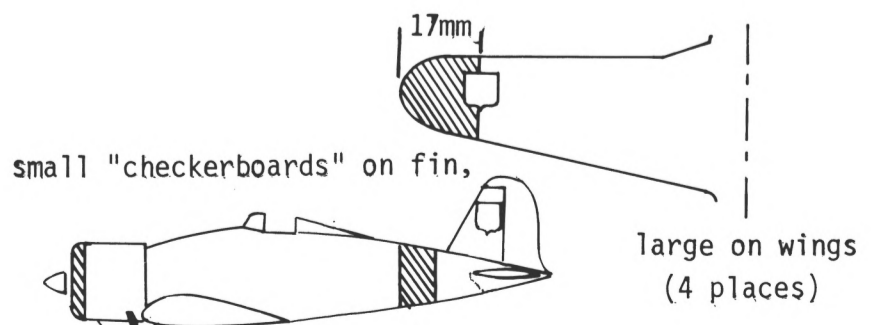

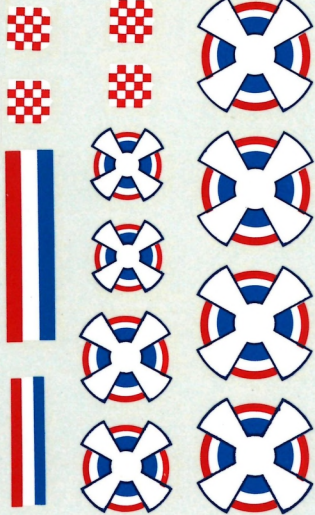

L-12  
2903

2

10  
53  
25

ИК-2  
БР 2110  
HS-УС<sub>15</sub>

ХАВКЭР  
ФУРИ IА  
БР02  
КЭСТРЭЛ II

БР10

ЭНОВ  
ФУРИ  
БР13  
КЭСТРЭЛ III

НУСЛАХИ  
УНГА АИ  
БР011  
НУСЛАХИ II

2108

↓

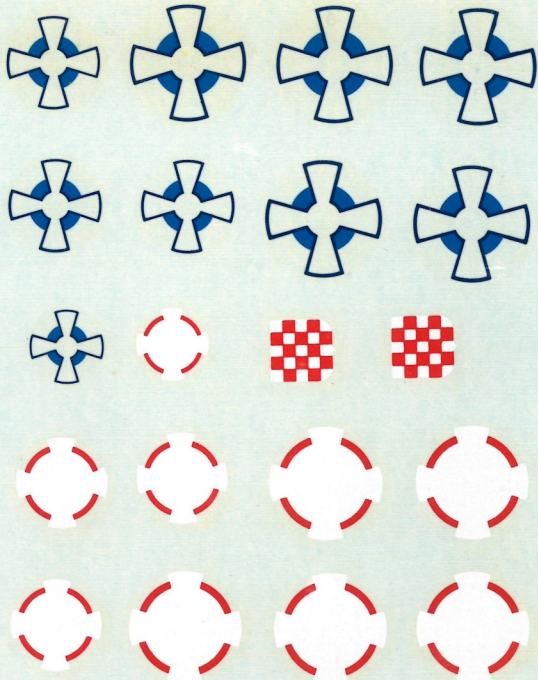

**ADDENDUM. Not from original manual**

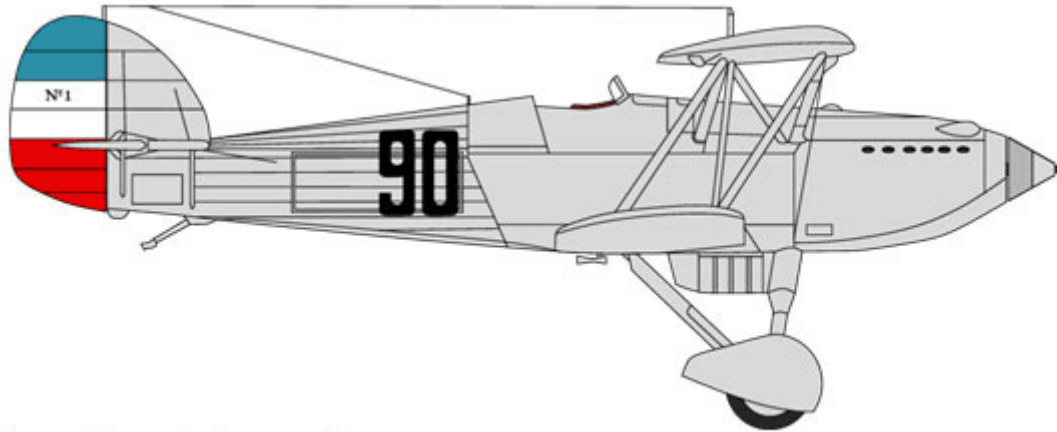

## ***Hawker Fury I***

**Hawker Fury Mk.Ia 6 Puk, standard scheme (same as for number „2“)**



**Hawker Fury Mk.II Hawker Fury Mk.II**



**Hawker Hurricane Mk.I**



ADDENDUM. Not from original manual

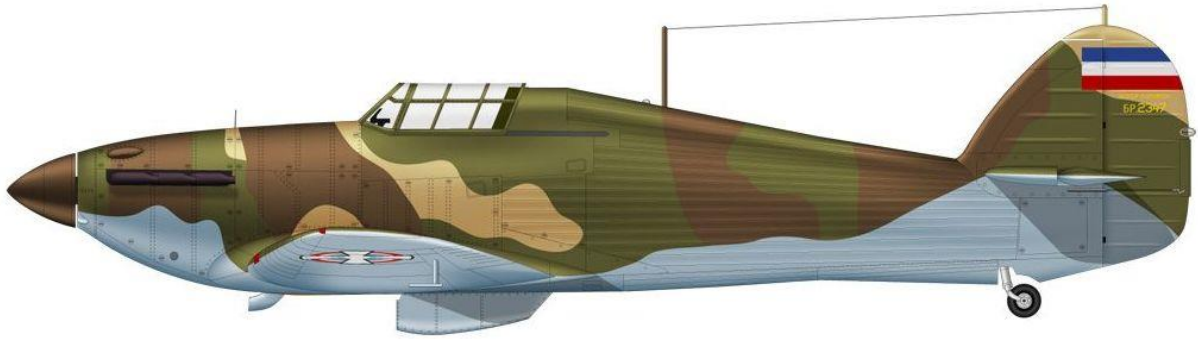

## Zmaj-Hawker Hurricane Mk.I

Fighter



Royal Yugoslavian  
Air Force

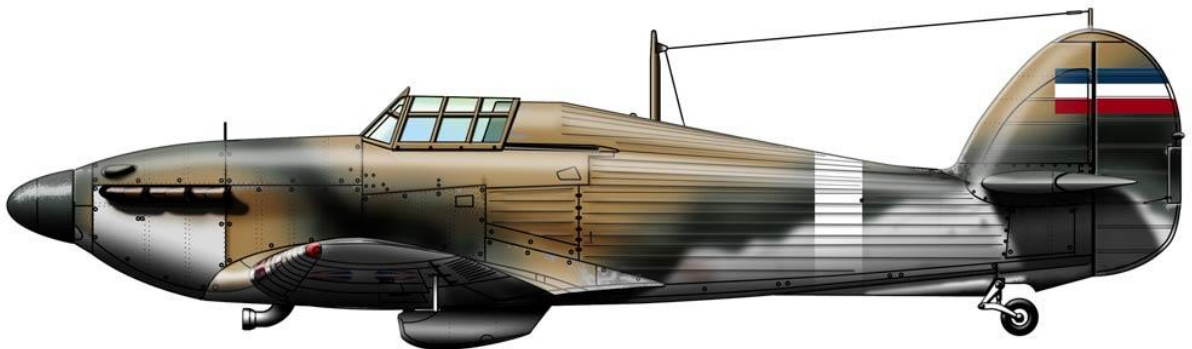

ADDENDUM. Not from original manual

Ikarus IK-2 first serie production plane during the evaluation flights late 1939

Ikarus IK-2 premier serie de production en serie, fin 1939

**CAM A**

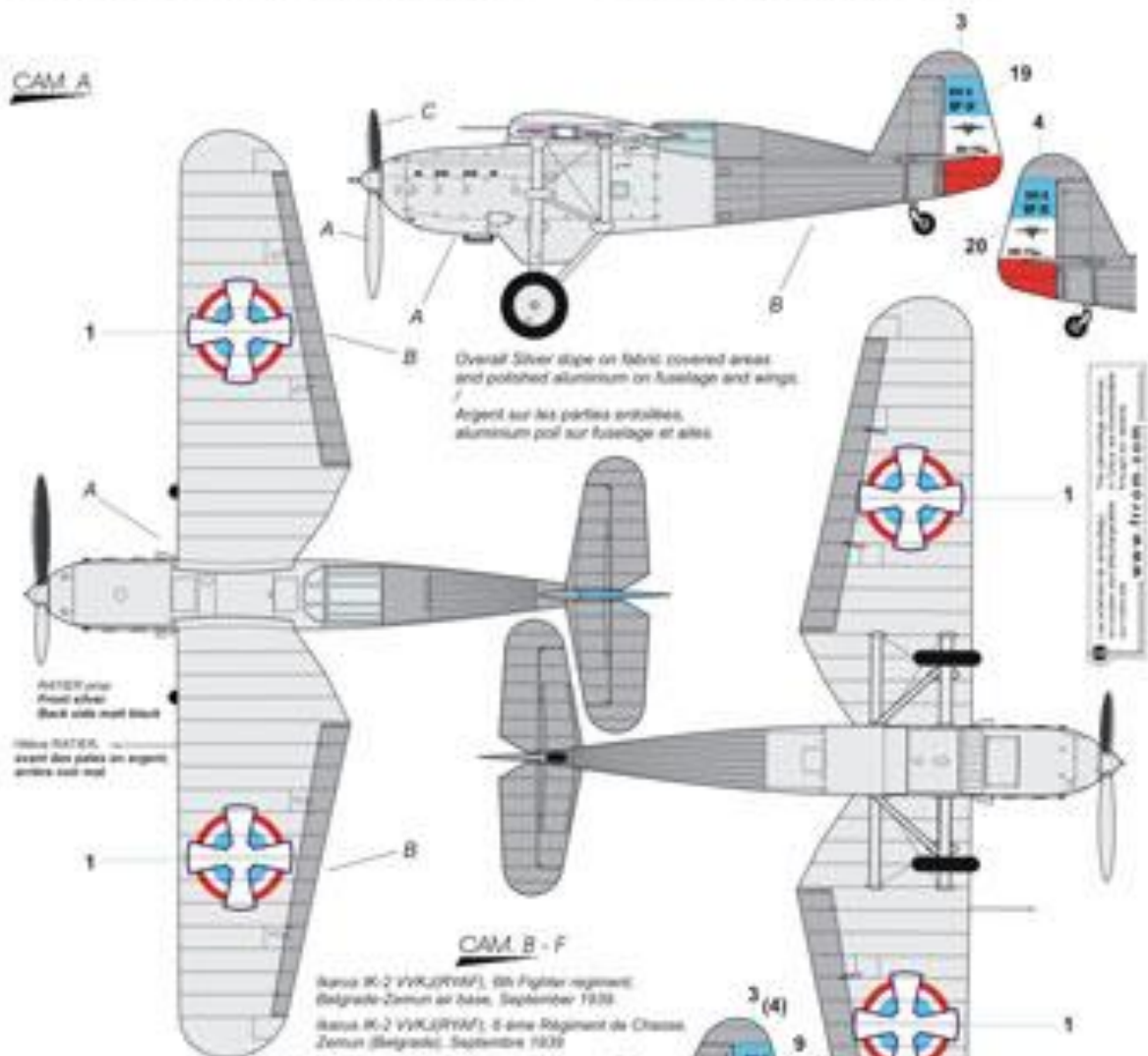

**CAM B - F**

Ikarus IK-2 VVKJ(PYMF), 5th Fighter Regiment, Belgrade-Zemun air base, September 1939

Ikarus IK-2 VVKJ(PYMF), 5eme Regiment de Chasse, Zemun (Belgrade), Septembre 1939

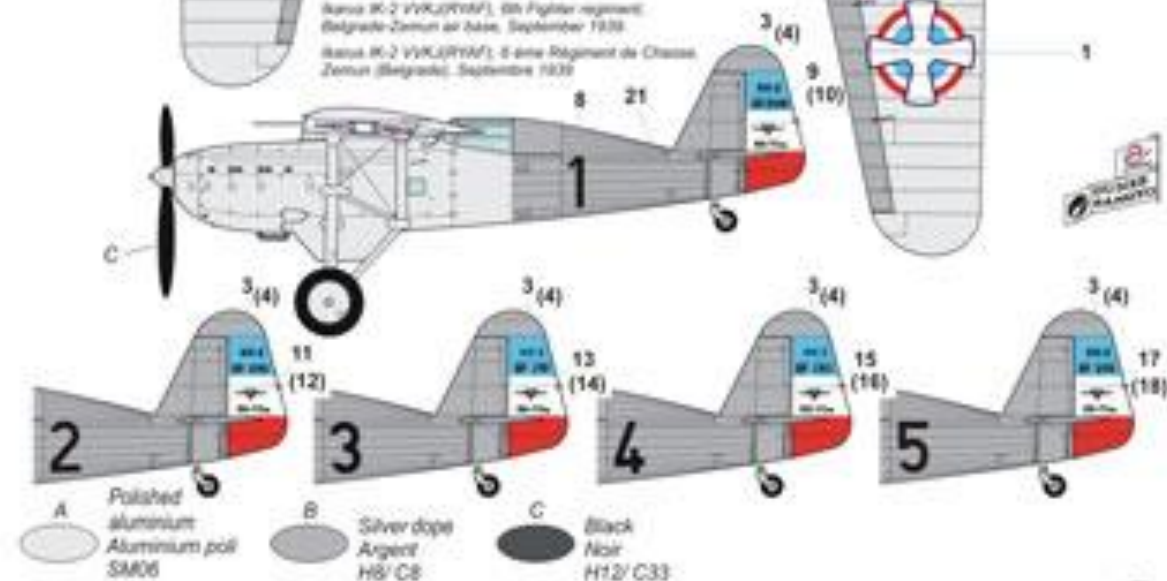

**ADDENDUM. Not from original manual**



Yugoslav IK-2 107 Eskadrila, 34 Grupa, 4 Lovački Puk No.2108



IK-2 in NDH service

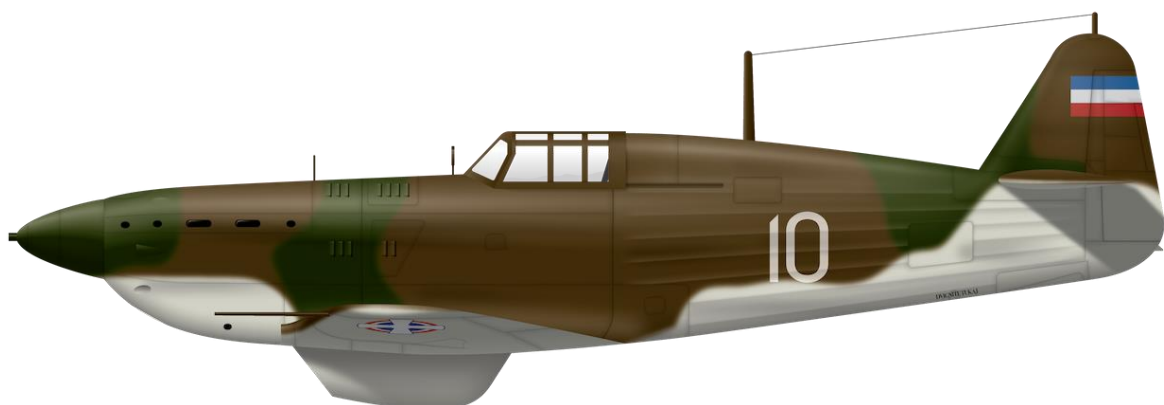

IK-3 161.Eskadrilla, 51.Grupa No.2159 Br.10 – April 1941

**ADDENDUM. Not from original manual**

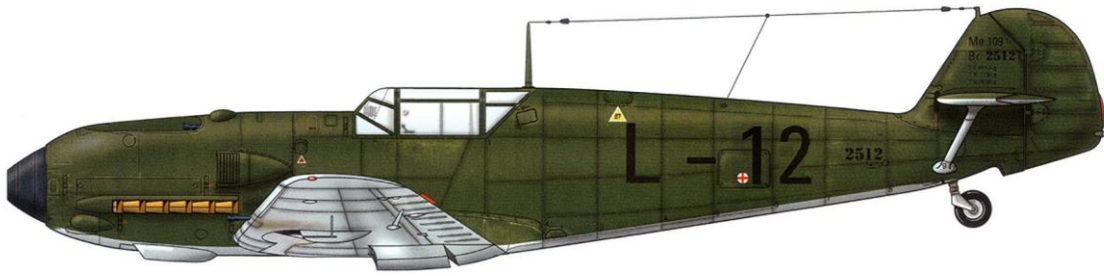

Messerschmitt Me-109E-3, 6. lovački puk, 32. lovačka grupa, JKRV (Jugoslovensko Kraljevsko Ratno Vazduhoplovstvo), L-12 WNr 2512 Yugoslavia 1941

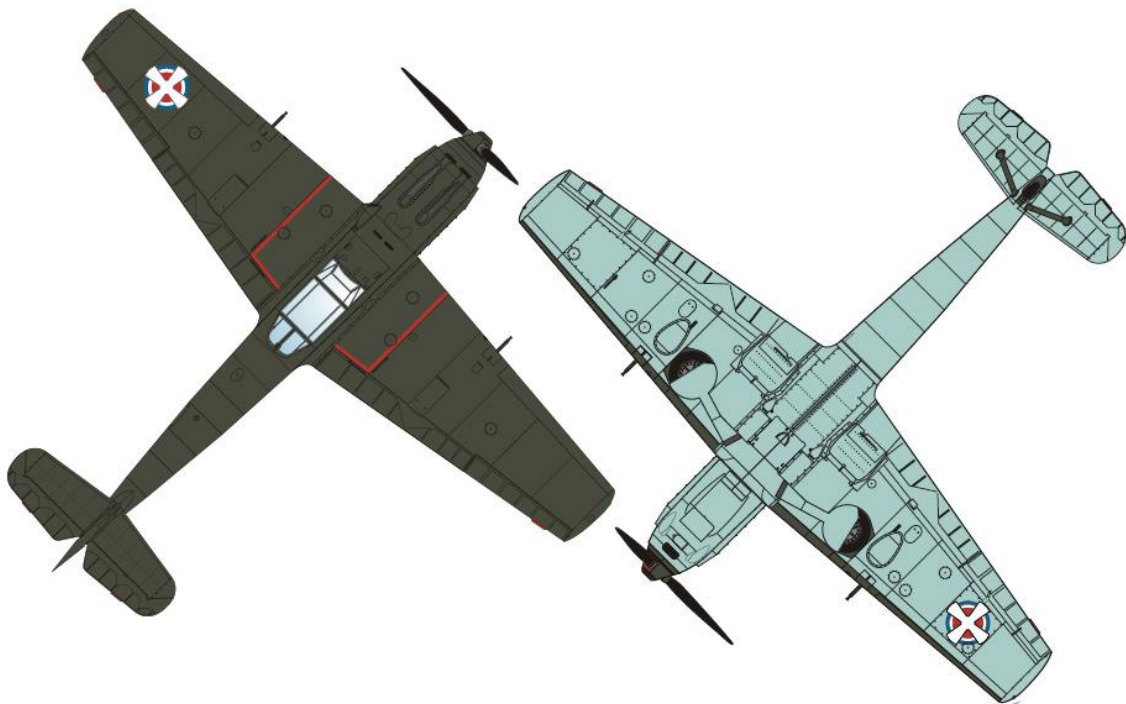



**ADDENDUM. Not from original manual**

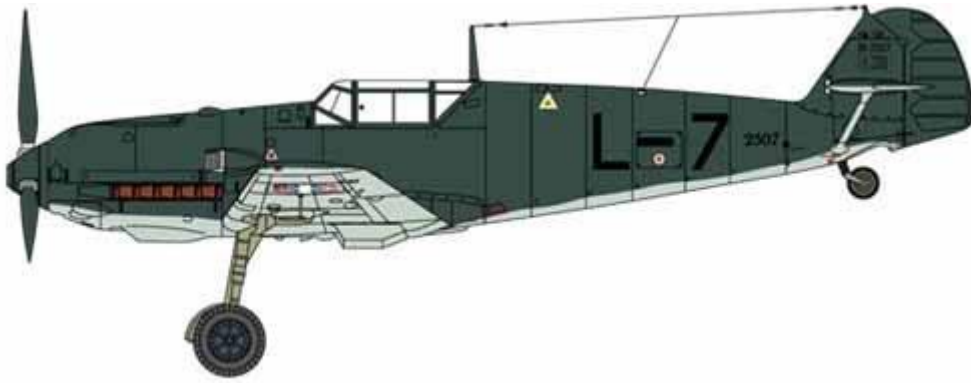

Messerschmitt Me-109E-3, 6. lovački puk, 51. lovačka grupa, JKRV (Jugoslovensko Kraljevsko Ratno Vazduhoplovstvo), L-7 WNr 2507 Yugoslavia 1941

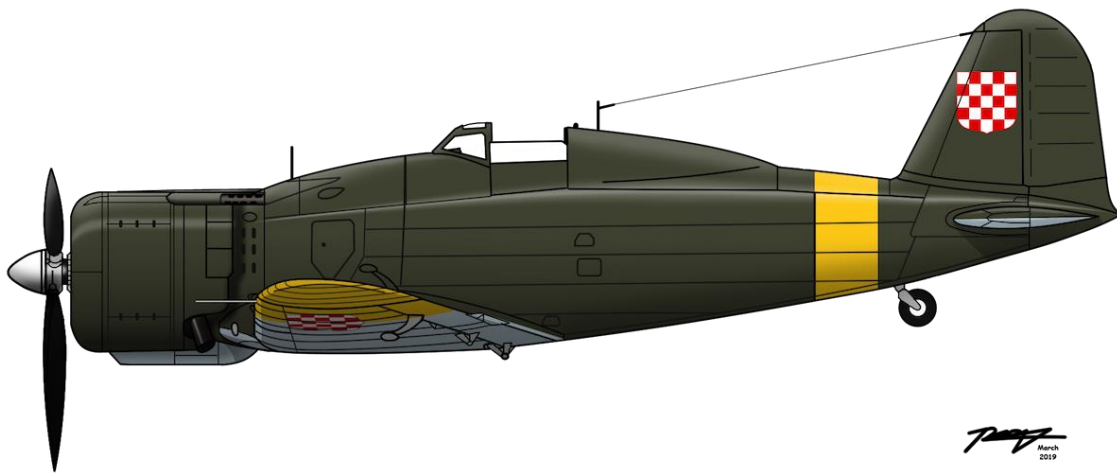

Fiat G.50 NDH