

81011

1-400

# Heller

## TORPEDOBOOT T23 - 1943 -

Three of these ships were incorporated in the French Navy, 2 of them served under the names of ALSACIEN and LORRAIN.

Displacement ..... 1100 TW - 1600 PC  
 Length ..... 102 m  
 Width ..... 9,50 m  
 Draught ..... 3,60 (PC)  
 Power ..... 35000 CV  
 Propulsion unit ..... 4 WAGNER boilers - 2 gear turbines  
 Speed ..... 32 knots  
 Range ..... 2600 miles  
 Weapons ..... 4 x 105 mm - 4 x 37 mm - 8 to 12 x 20 mm  
 6 x TLT av 533 - 70 mines

La Marine Nationale a reçu trois de ces bâtiments et deux d'entre eux ont servi sous le nom d'ALSACIEN et de LORRAIN.

Displacement ..... 1100 TW - 1600 PC  
 Longueur ..... 102 m  
 Largeur ..... 9,50 m  
 Tirant d'eau ..... 3,60 (PC)  
 Puissance ..... 35000 CV  
 Propulsion ..... 4 chaudières WAGNER - 2 turbines à engrenage  
 Vitesse ..... 32 nœuds  
 Rayon d'action ..... 2600 milles  
 Armement ..... 4 x 105 mm - 4 x 37 mm - 8 à 12 x 20 mm  
 6 x TLT de 533 - 70 mines

Die französische Marine erhielt drei dieser Boote und zwei davon dienten unter den Namen ALSACIEN und de LORRAIN.

Verdrängung ..... 1100 TW - 1600 PC  
 Länge ..... 102 m  
 Breite ..... 9,5 m  
 Tiefgang ..... 3,60 (PC)  
 Leistung ..... 35000 PS  
 Antrieb ..... 4 Kessel WAGNER - 2 Zahnradturbinen  
 Geschwindigkeit ..... 32 Knoten  
 Reichweite ..... 2600 Meilen  
 Bewaffnung ..... 4 x 105 mm - 4 x 37 mm - 8 bis 12 x 20 mm  
 6 x TLT 533 - 70 Minen

La Marina Nacional francesa recibió tres de estos buques y dos de ellos han servido con los nombres de ALSACIEN y de LORRAIN.

Desplazamiento ..... 1100 TW - 1600 PC  
 Longitud ..... 102 m  
 Ancho ..... 9,50 m  
 Manga ..... 3,60 (PC)  
 Potencia ..... 35000 CV  
 Propulsión ..... 4 calderas WAGNER - 2 turbinas de engranaje  
 Velocidad ..... 32 V nudos  
 Radio de acción ..... 2600 millas nauticas  
 Armamento ..... 4 x 105 mm - 4 x 37 mm - 8 a 12 x 20 mm  
 6 x TLT de 533 - 70 minas

La Marina Nazionale francese ha ricevuto tre navi e di queste tipo, di cui due hanno servito sotto il nome di ALSACIEN e di LORRAIN.

Displacement ..... 1100 TW - 1600 PC  
 Lunghezza ..... 102 m  
 Larghezza ..... 9,50 m  
 Profondità ..... 3,60 (PC)  
 Potenza ..... 35000 CV  
 Propulsione ..... 4 caldaie WAGNER - 2 turbine a ingranaggio  
 Velocità ..... 32 nodi  
 Raggio d'azione ..... 2600 miglia  
 Armamento ..... 4 x 105 mm - 4 x 37 mm - da 8 a 12 x 20 mm  
 6 x TLT di 533 - 70 mine

De Nederlandse Zee-macht ontving drie van deze vaartuigen en twee onder hen hebben onder de naam ALSACIEN en LORRAIN gediend.

Waterverplaatsing ..... 1100 TW - 1600 PC  
 Lengte ..... 102 m  
 Breedte ..... 9,50 m  
 Diepgang ..... 3,60 (PC)  
 Vermogen ..... 35000 PK  
 Voortruiwing ..... 4 WAGNER ketels - 2 landvoertuigen  
 Snelheid ..... 32 knopen  
 Actieradius ..... 2600 mijlen  
 Ausrusting ..... 4 x 105 mm - 4 x 37 mm - 8 à 12 x 20 mm  
 6 TLT van 533 - 70 mijnen

Franska Nationalflottan har mottagit tre av dessa fartyg och två av dem har tjänat under namnen ALSACIEN och LORRAIN.

Displacement ..... 1100 TW - 1600 PC  
 Längd ..... 102 m  
 Bredd ..... 9,50 m  
 Djupgående ..... 3,60 (PC)  
 Drivkraft ..... 35000 hk  
 Framdrivning ..... 4 ångpannor WAGNER 2 utväxlingsmaskiner  
 Hastighet ..... 32 knop  
 Aktionsradie ..... 2600 mil  
 Beväpning ..... 4 x 105 mm - 4 x 37 mm - 8 till 12 x 20 mm  
 6 x TLT av 533 - 70 minor

Ruukkaan laivasto on saanut kolme tällaista laivaa ja kaksi niistä on ollut nimillä ALSACIEN ja LORRAIN.

Loppuma ..... 1100 TW - 1600 PC  
 Pituus ..... 102 m  
 Leveys ..... 9,50 m  
 Syväys ..... 3,60 (PC)  
 Voimav ..... 35000 HV  
 Työntövoima ..... 4 höyrykattilaa WAGNER - 2 välitystehoa  
 Nopeus ..... 32 solmia  
 Toimintatied ..... 2600 merimailun  
 Aseistus ..... 4 x 105 mm - 4 x 37 mm - 8-12 x 20 mm  
 6 x TLT 533 - 70 miinaa

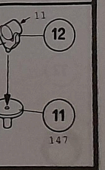
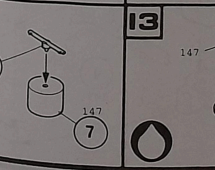
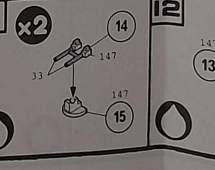
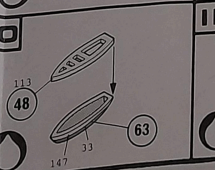
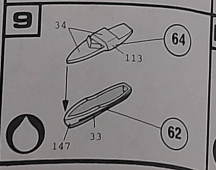
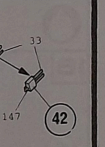
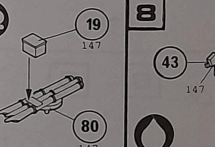
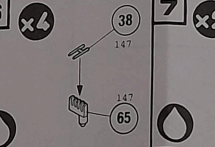
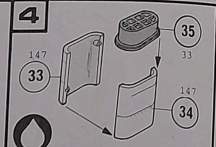
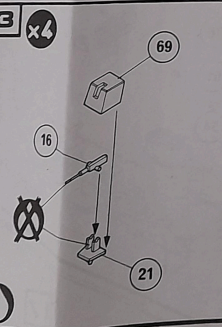
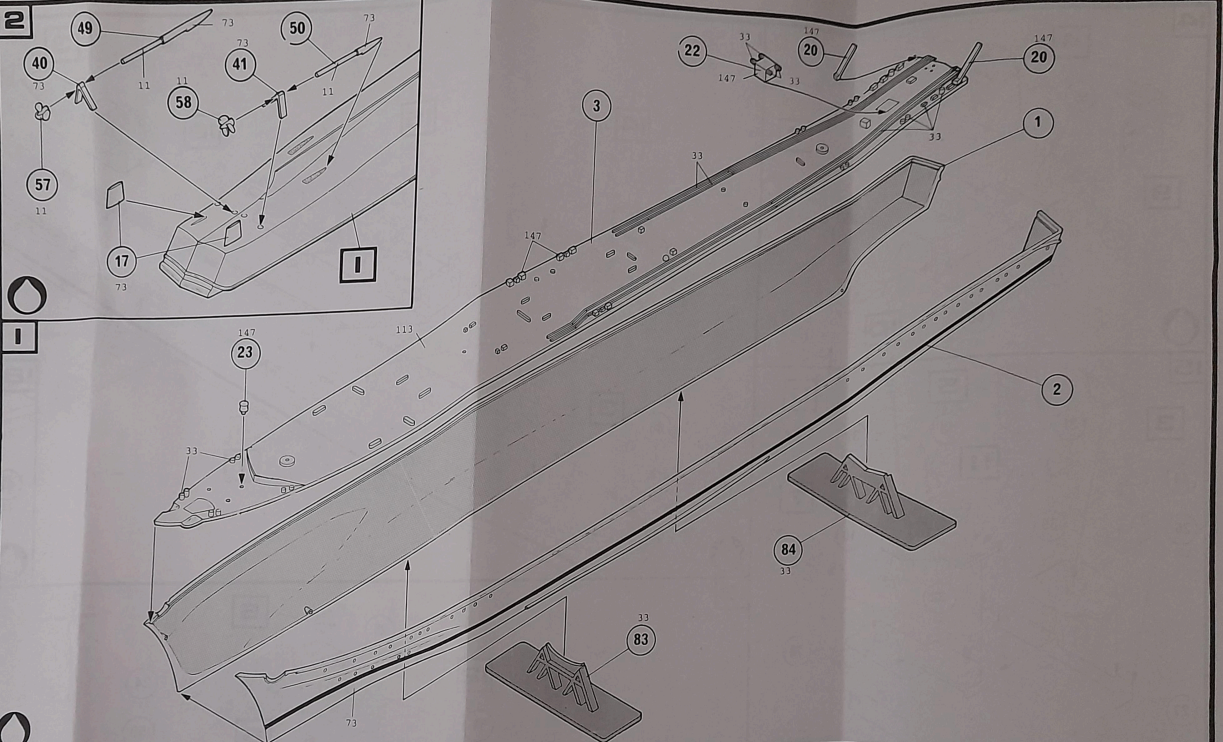

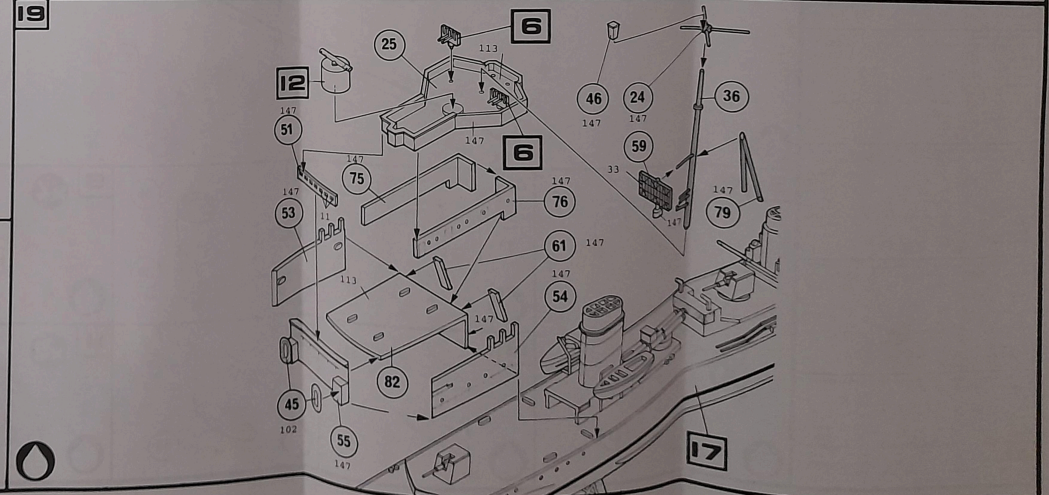
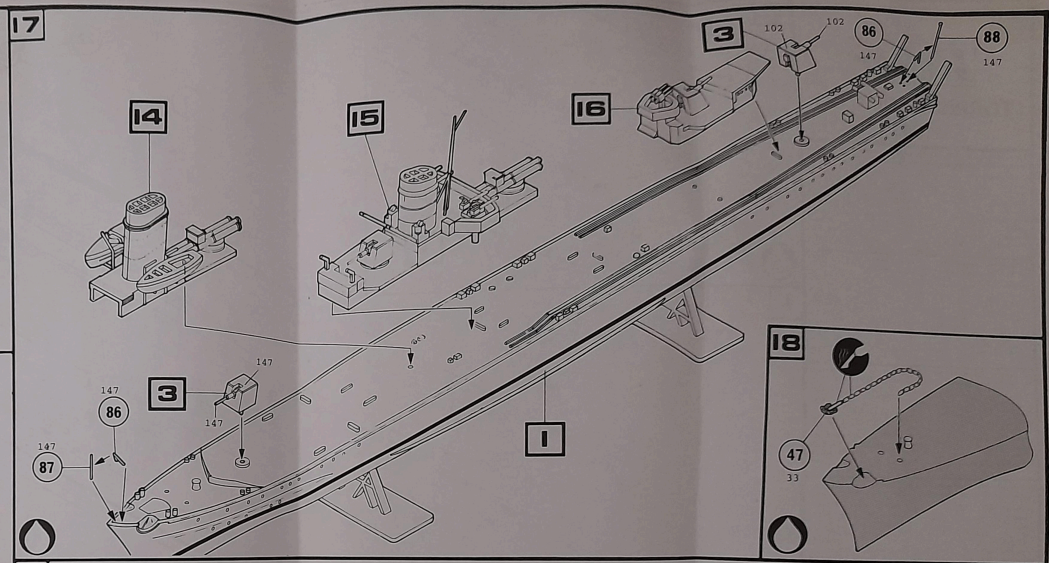
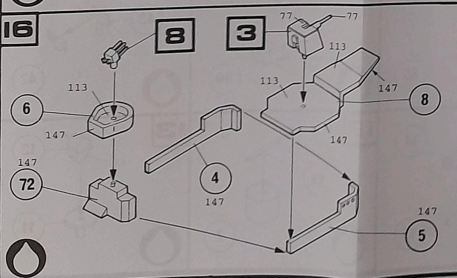
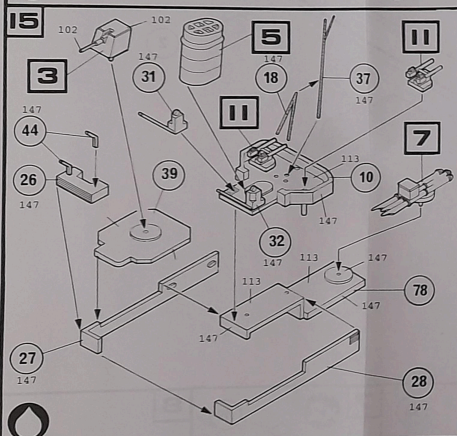
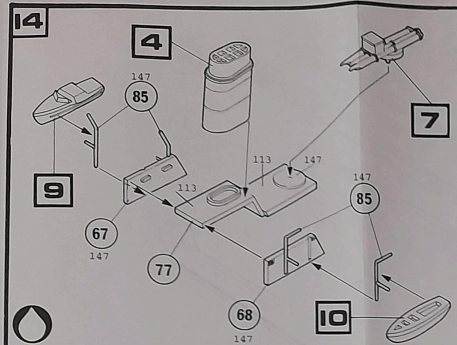

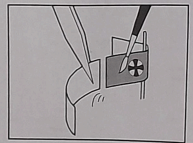
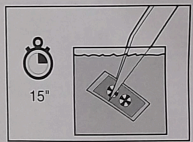
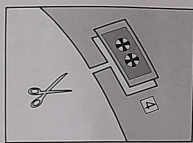
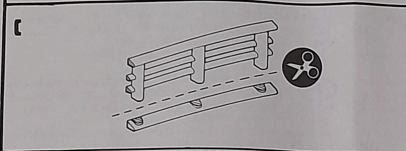
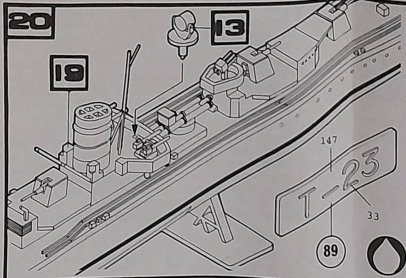

TORPEDOBOOT T23-1943

- 77
- 73
- 102
- 147
- 34

