

**AZ model**  
Plastic kits

# AVRO 626

## Prefect (Tatra T-126)

Plastic model

scale : 1/72

### History

The Model 626 was developed by Avro from the company's Model 621 (Tutor) for export to smaller air forces, the idea being that the 626 would be a single aircraft that could carry out general aircrew training as well as a number of other roles. The types 621 and 626 were both two-seaters, but the latter had an additional cockpit behind the rear seat of the 621 and accessible from it. This additional cockpit was fitted with a Scarff ring for a machine gun and carried equipment for air navigation, wireless and gunnery training. Structurally and aerodynamically, it was almost identical to the Tutor: it had a conventional fabric-covered, metal airframe with single-bay wings. Most of the 626s, like the Tutors had an Armstrong Siddeley Lynx IVC engine of 240 hp (180 kW), but most of those supplied to the Egyptian and Brazilian Air Forces used a 260 hp (190 kW) Cheetah V from the same maker.

The usual undercarriage used split, fixed mainwheels and either a tailskid or later a tailwheel, but some 621s appeared on floats and on skis.

### Plastic parts

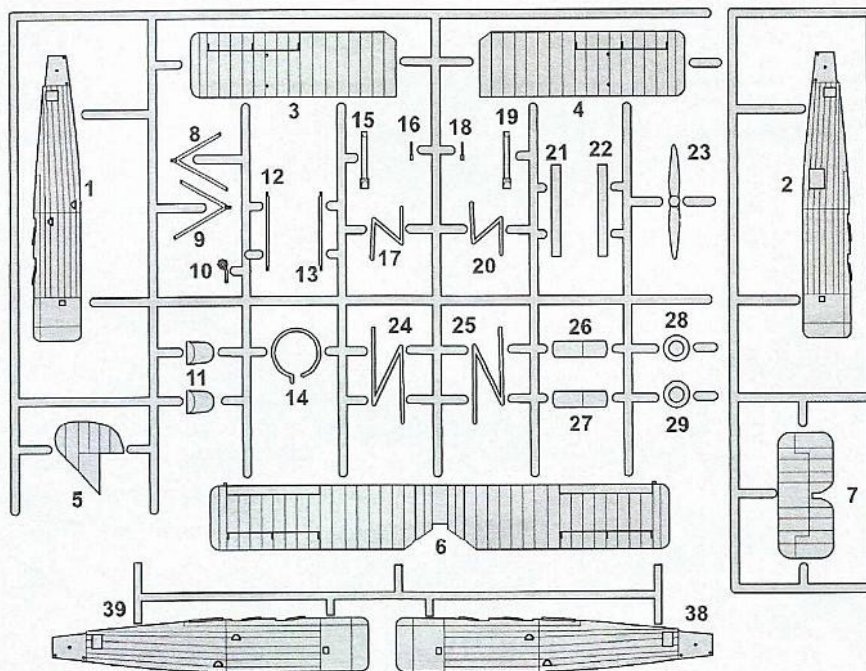

### Clear parts

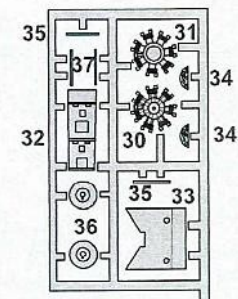

### Symbols



	Colour name	Humbrol		Colour name	Humbrol
<b>A</b>	Black	H33	<b>G</b>	Aluminium	H56
<b>B</b>	White	H34	<b>H</b>	Silver	H11
<b>C</b>	Interior Green	H76	<b>I</b>	Linen	H74
<b>D</b>	Gunmetal	H53	<b>J</b>	Red	H132
<b>E</b>	Dark Grey	H27	<b>K</b>	Tyre	H85
<b>F</b>	Green	H120	<b>L</b>	Rust	H113



Assembly instructions

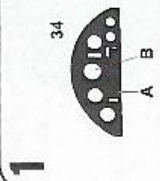

**1**

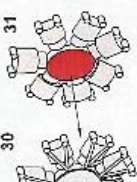

**2**

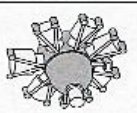

**3**

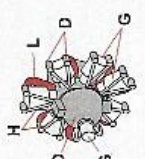

Assembly instructions

**12**

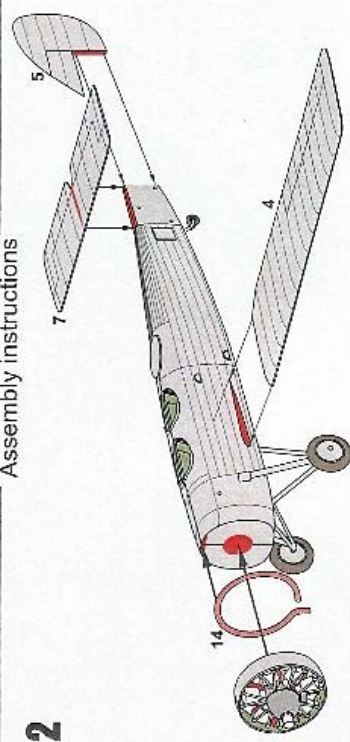

**13**

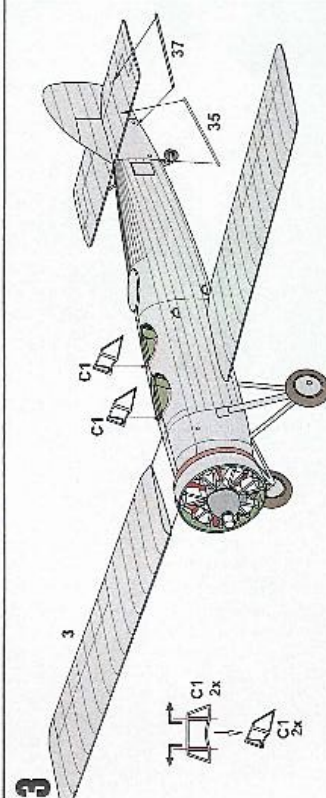

**14**

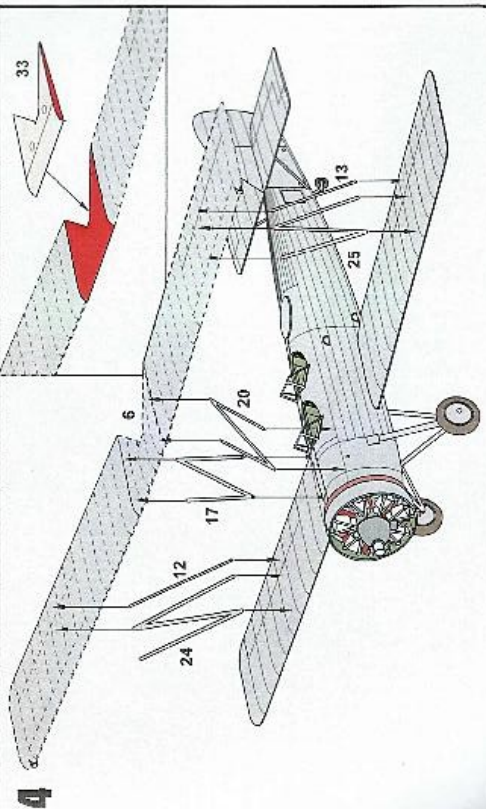

Assembly instructions

**4**

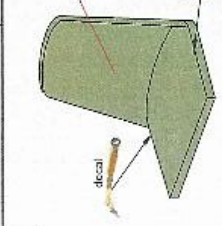

**6**

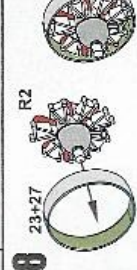
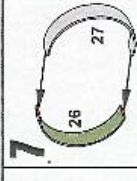
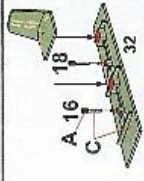

**9**

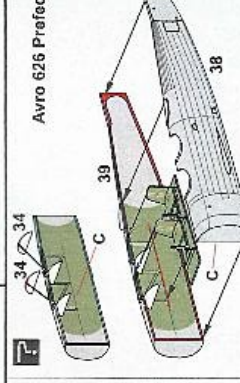
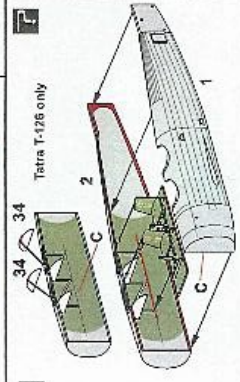

**10**

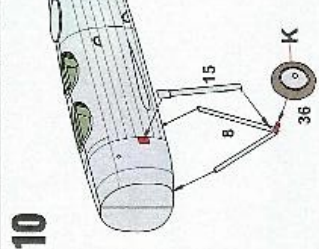

**11**

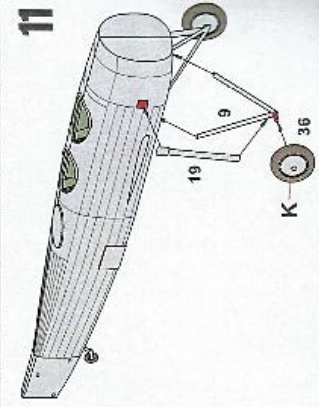



# Assembly instructions

**15**

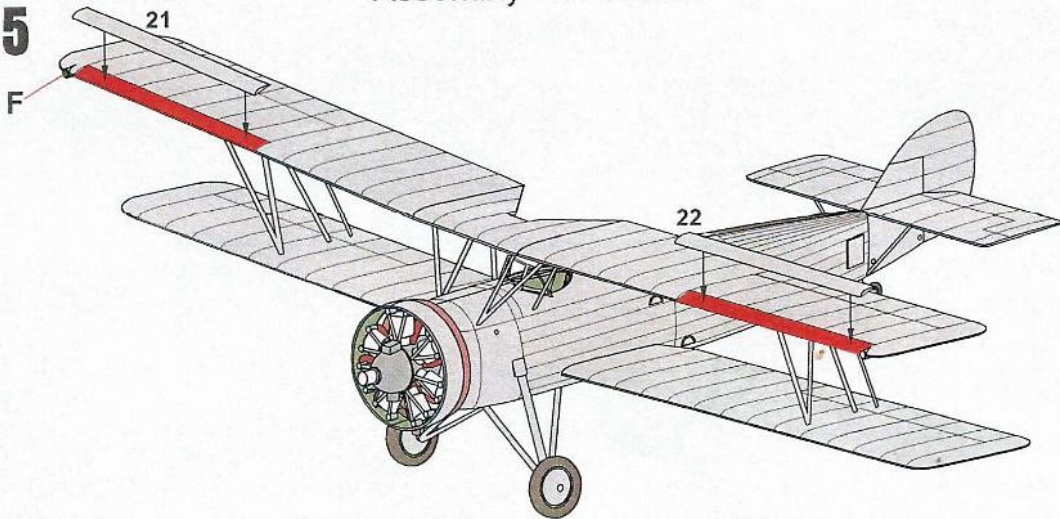

**16**

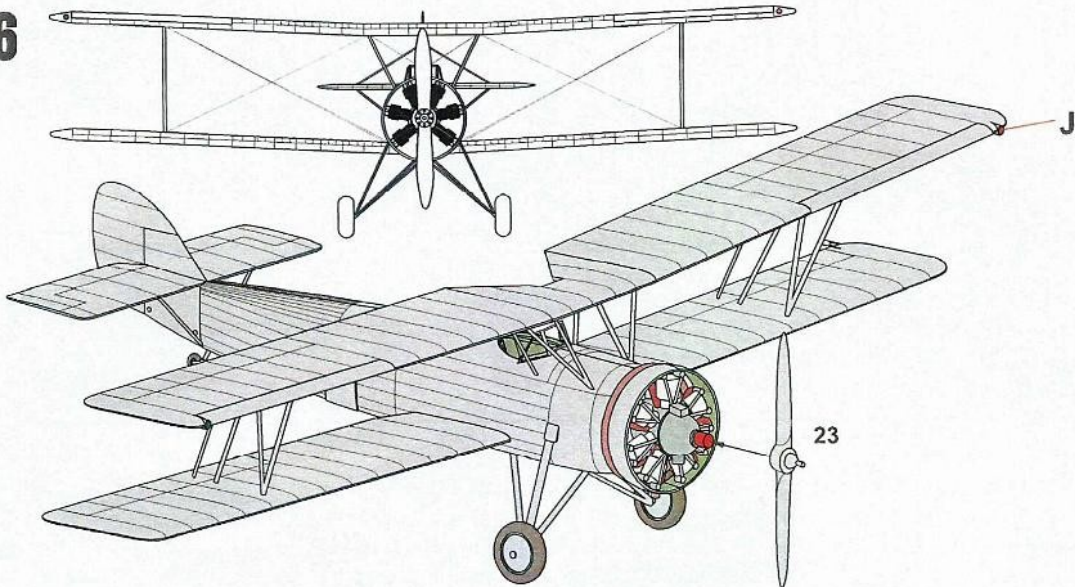

**17**

## Rigging

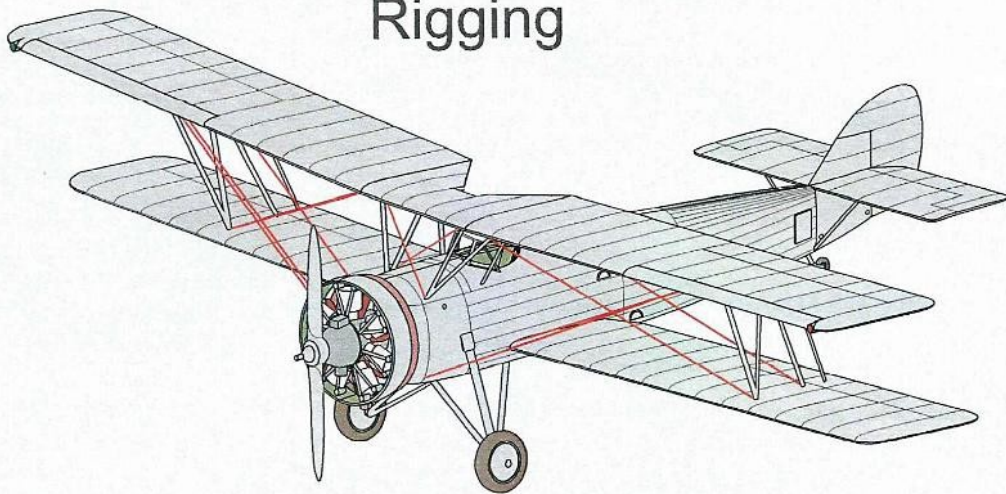

## Zbarvení & Označení Colours & Markings

**1** Tatra T-126(Avro 626), Československé voj. letectvo, 1938.

Tatra T-126(Avro 626), Czechoslovak Air Force, 1938.

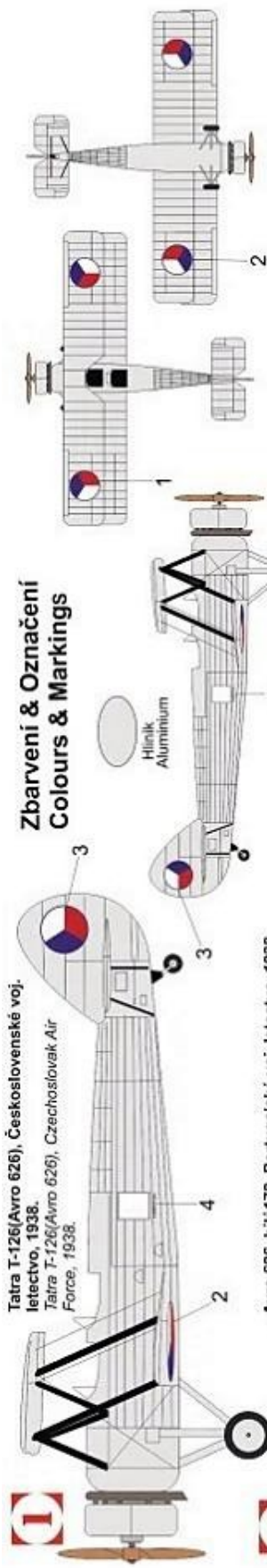

**2** Avro 626, bílá 178, Portugalské voj. letectvo, 1938.

Avro 626, White 178, Portugal Air Force, 1938.

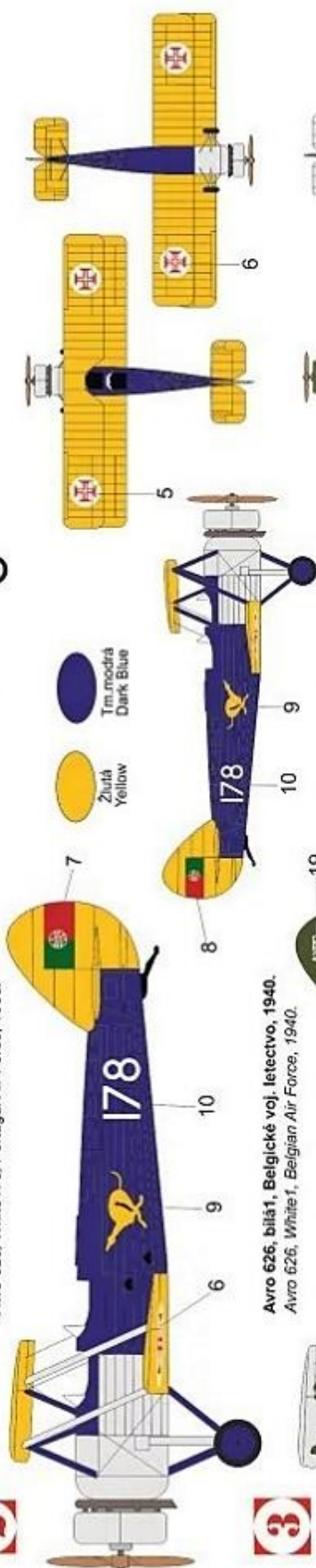

**3** Avro 626, bílá 1, Belgické voj. letectvo, 1940.

Avro 626, White 1, Belgian Air Force, 1940.

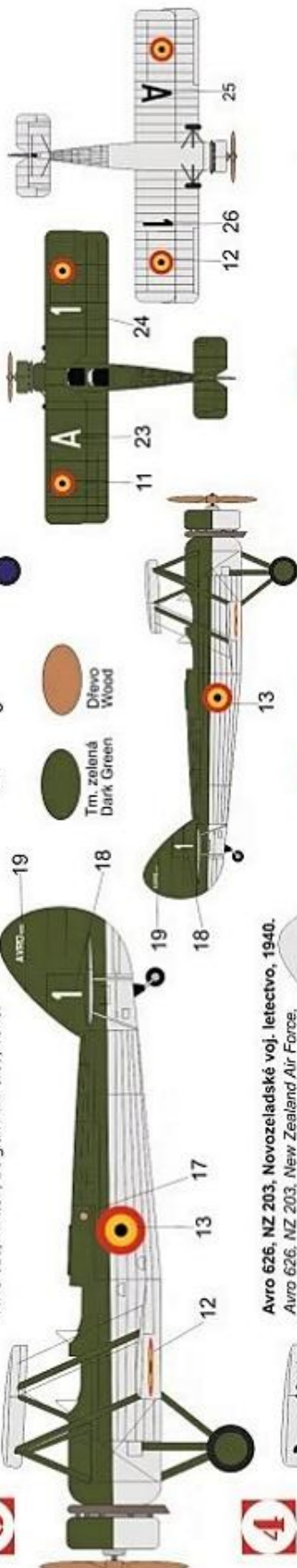

**4** Avro 626, NZ 203, Novozelandské voj. letectvo, 1940.

Avro 626, NZ 203, New Zealand Air Force, 1940.

