

# 672 034 German Submarine 8,8cm gun

For Revell kit - pro stavebnici Revell

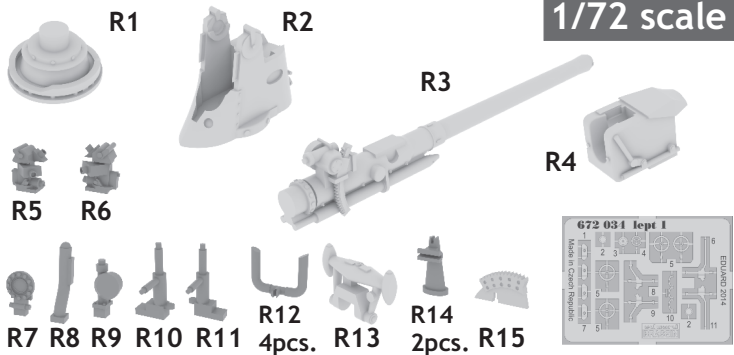

1/72 scale



### COLOURS

GSI Creos (GUNZE)		Mr.METAL COLOR	
AQUEOUS	Mr.COLOR	Mr.METAL COLOR	
H305	C305	GRAY	
	C92	SEMI GLOSS BLACK	

This product contains metal and resin detail parts for upgrading scale plastic models. When selecting this set make sure that it is for the kit mentioned in product name as these sets are made specifically for that kit. When upgrading the model some cutting or corrections may be necessary for parts to fit accurately. **WARNING!** This set contains small and sharp parts. Work carefully in a ventilated and well-lit room. Safety glasses are recommended. This product is not suitable for children below 14 years of age.

Tento výrobek obsahuje leptané a odlévané detaily pro úpravu a vylepšení plastického modelu. Při výběru sady kovových detailů zkontrolujte, zda je určena pro model, který chcete upravit. Model, pro který je sada určena, je uveden u názvu výrobku. Pro přesnou aplikaci kovových a odlévaných dílů může být zapotřebí upravit díly upravovaného modelu. **POZOR!** Sada obsahuje malé ostré díly. Pracujte ve větrané a dobře osvětlené místnosti. Doporučujeme použití ochranných brýlí. Tento výrobek není vhodný pro děti mladší 14 let.

**eduard**

435 21 Obrnice 170  
Czech Republic



www.eduard.com



# 672 034 German Submarine 8,8cm gun 1/72

For Revell kit - pro stavebnici Revell

**BRASSIN**







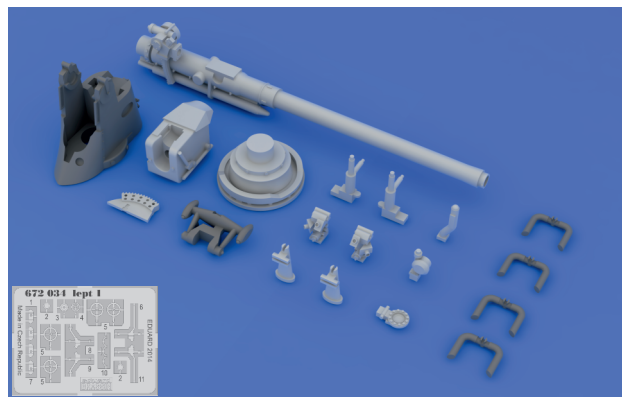



**BRASSIN**

**eduard**



**BEST BRASS RESIN AROUND!**

-  REMOVE  
ODSTRANIT
-  BEND  
OHNOUT
-  GRIND  
OBROUSIT
-  OPTION  
VOLBA
-  DRILL HOLE  
VRTAT OTVOR
-  REPLACE  
NAHRADIT
-  SYMMETRICAL ASSEMBLY  
SYMETRICKÁ MONTÁŽ
-  SCRIBE THE PANEL AND HOLES  
RYTÍ
-  REVERSE SIDE  
OTOČIT

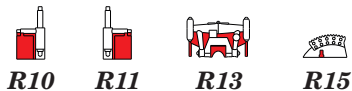
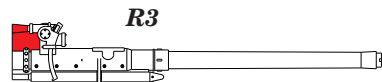

**A**

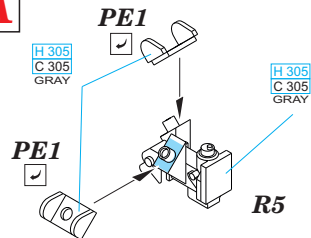

**B**

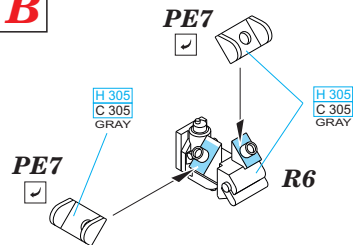

**1**

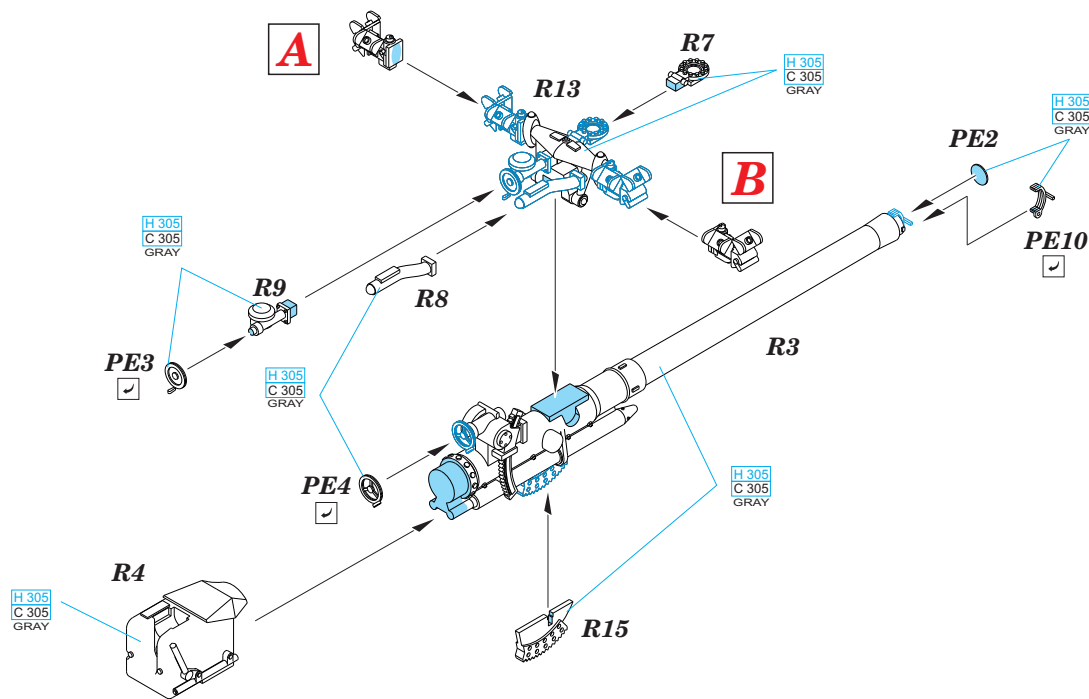

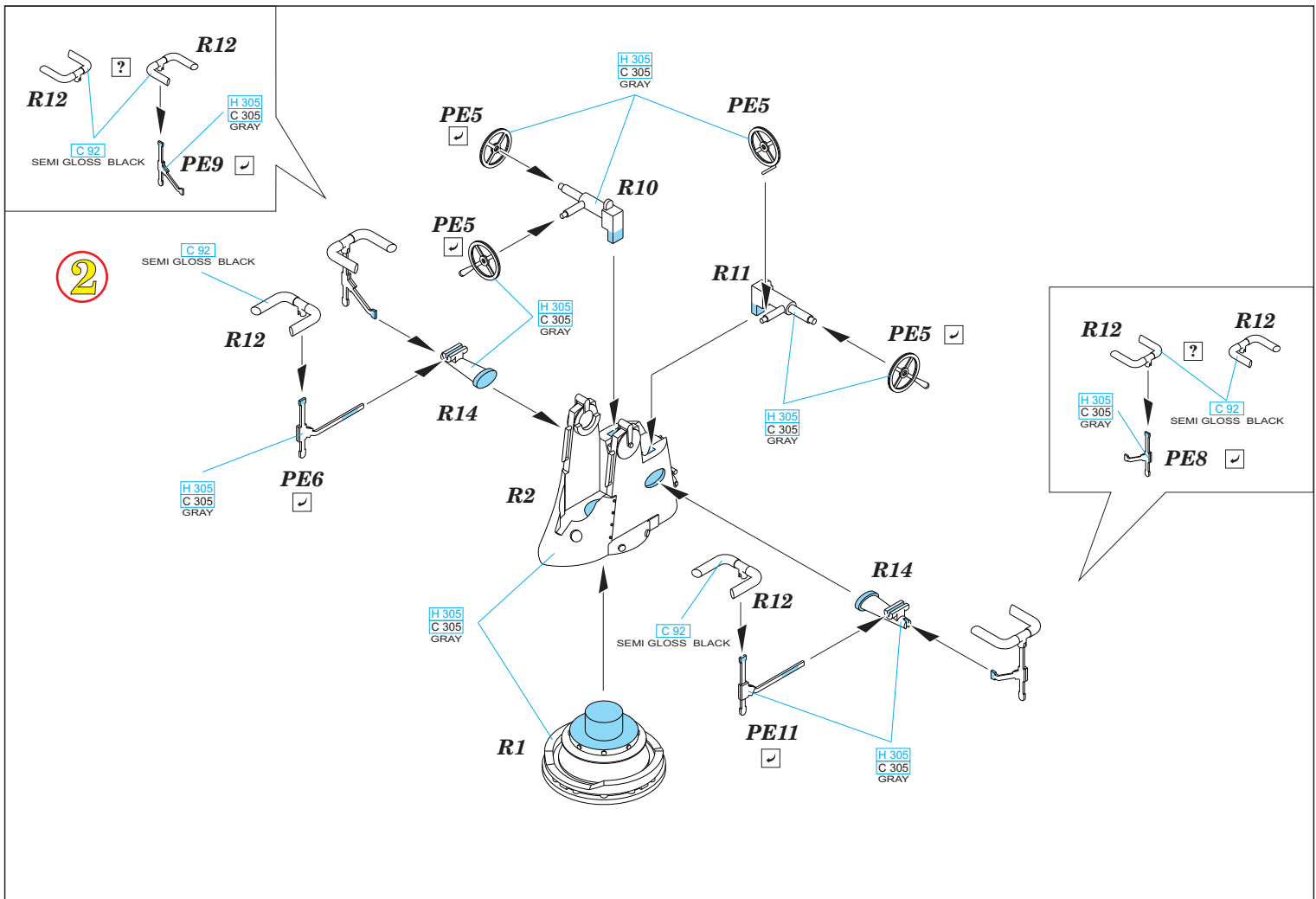

3

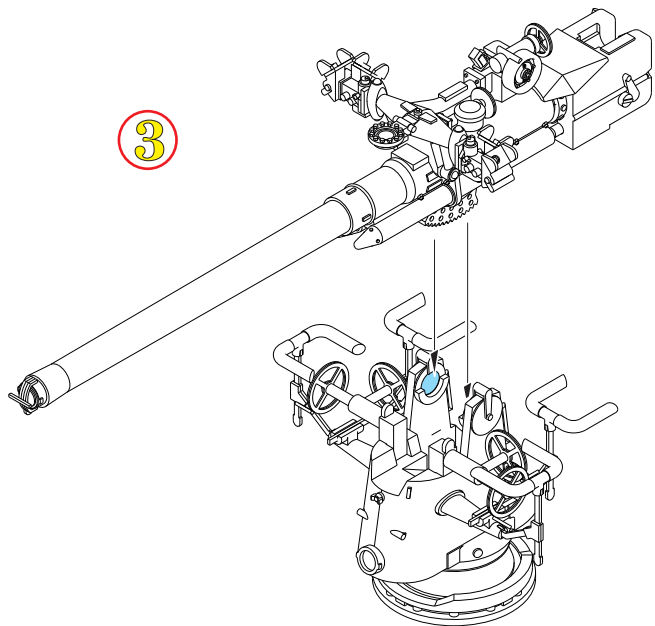

4

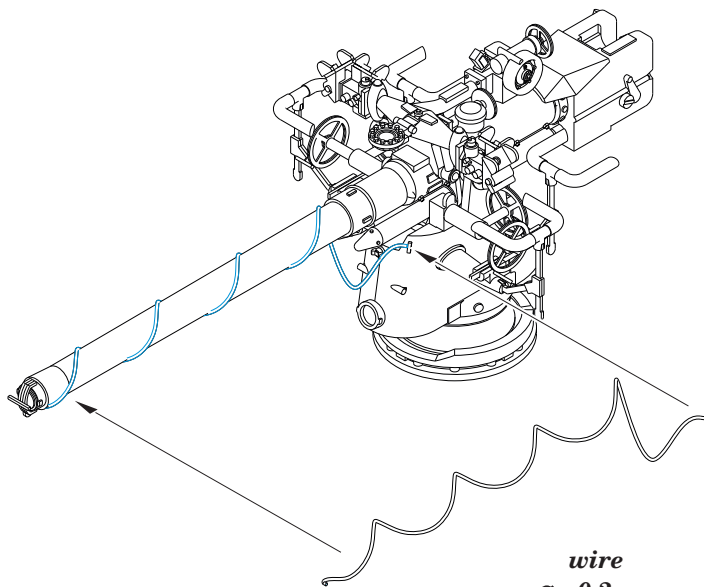

*wire*  
 $\varnothing$  - 0,2mm  
l - 51,5mm