

ASSEMBLY INSTRUCTIONS

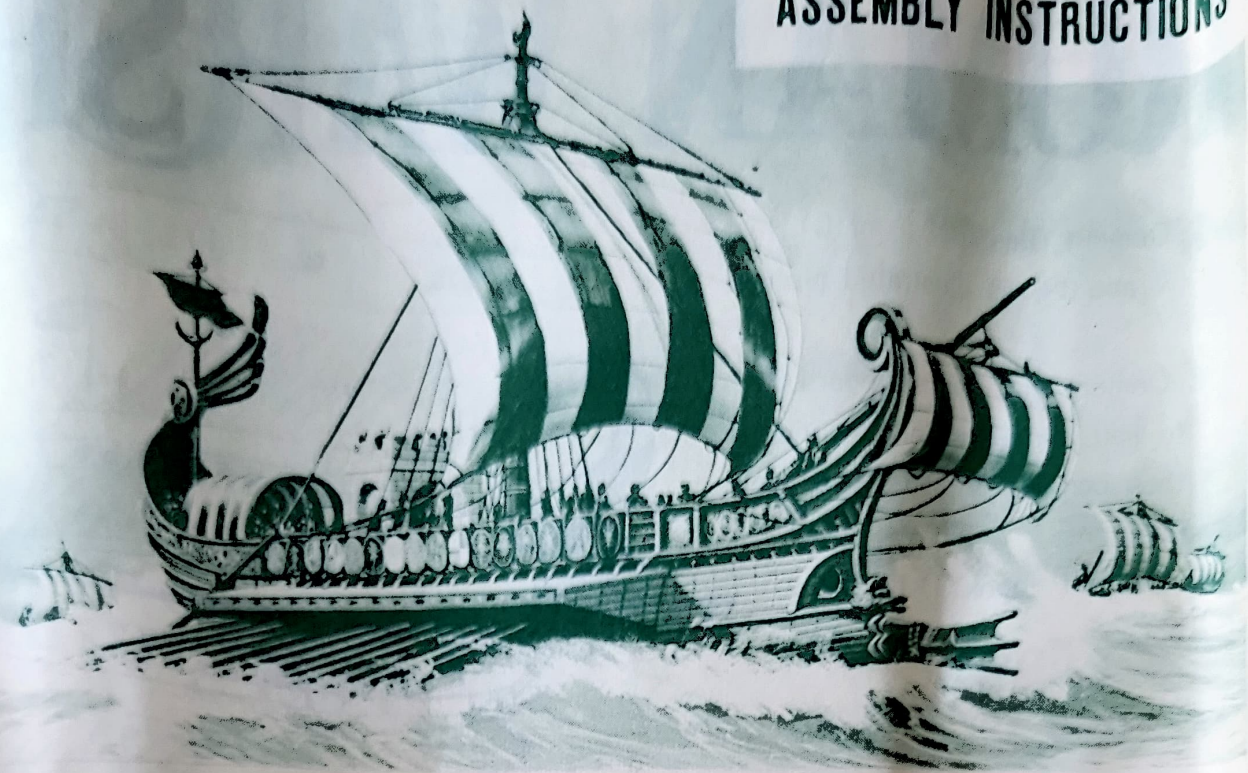

ROMAN WARSHIP

KIT NO. B-290

"Before assembling your model,
study illustrated picture carefully"

PARTS CHART

Parts Nos.	name
2	Half hull starboard
20	Half hull portside
1	Deck
23	Sail
9	Bow sprit
5	Sail
11	Mast
10	Flag pole
21-22	Oars
3	Rudder decks
4	"
7	Rudder bases
12-13	Rudders
14	Anchor
8	Turret parts
18	"
19	"
6	Tent
17	Name plate
15	Stand support
16	"
non	Stand supports(2 pos)
non	Stand base

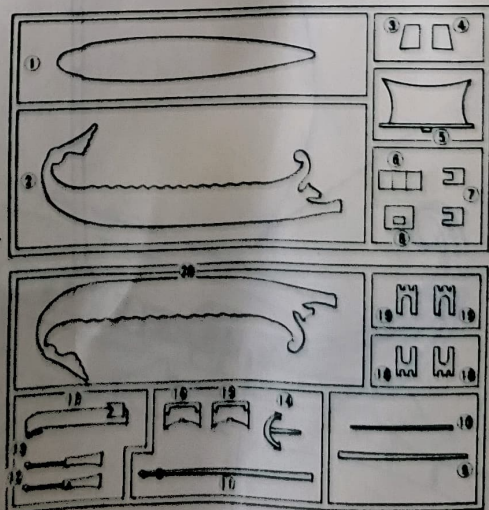

ROMAN WARSHIP

1. Cement Oars **21** **22** to half hulls **20** and **2**, as illustrated picture.

2. Cement half hull starboard **20** to half hull portside **2**, and then cement **3** and **4** to each positions.

3. Cement deck **1** to ship's body.

5. Cement sails **23** and **5** to each mast.

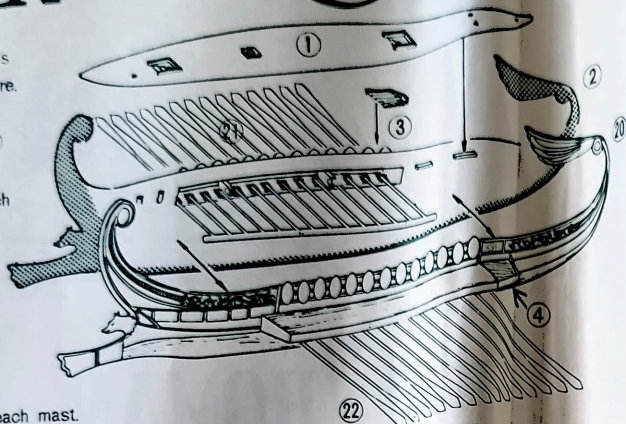

Details turret

Details rudder

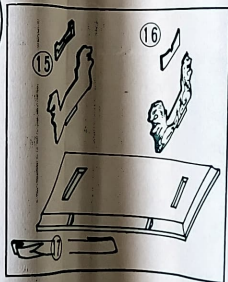
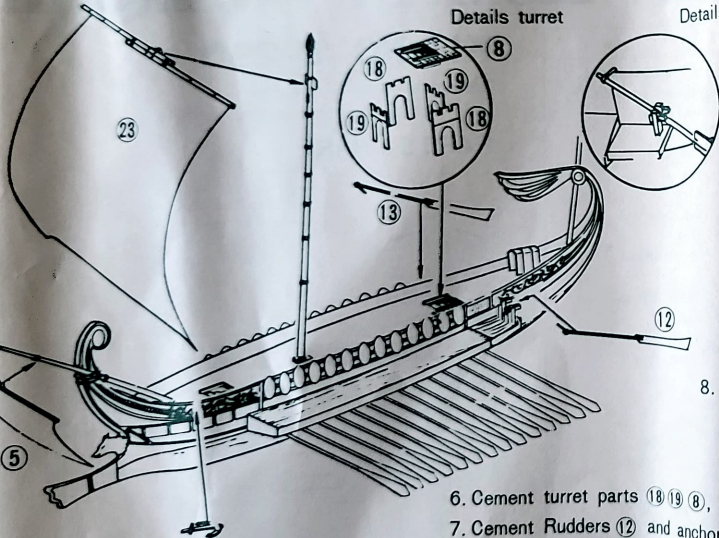

8. Assemble support stand
Cement **15** **16** and **17** to stand.

6. Cement turret parts **18** **19** **8**, and cement it to deck **1**.
7. Cement Rudders **12** and anchor **14** to each positions.

4. Cement each parts **6** **7** **9** **10** and **11** to deck **1**, as illustrated picture.

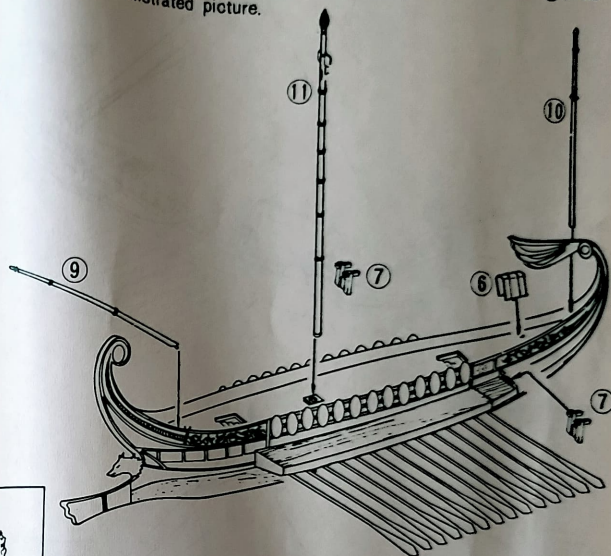

Plan of complete ship

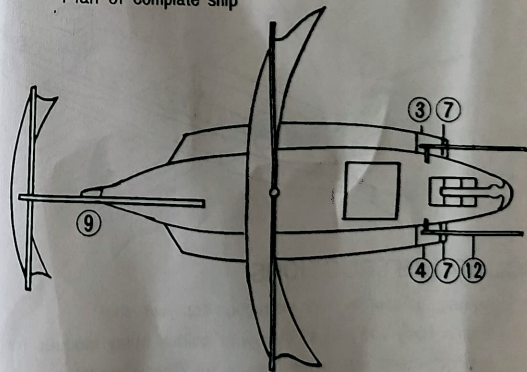

RIGGING INSTRUCTION

Rig each ropes as illustrated picture. (To be arranged machine cotton yourself for to make rigging ropes.)

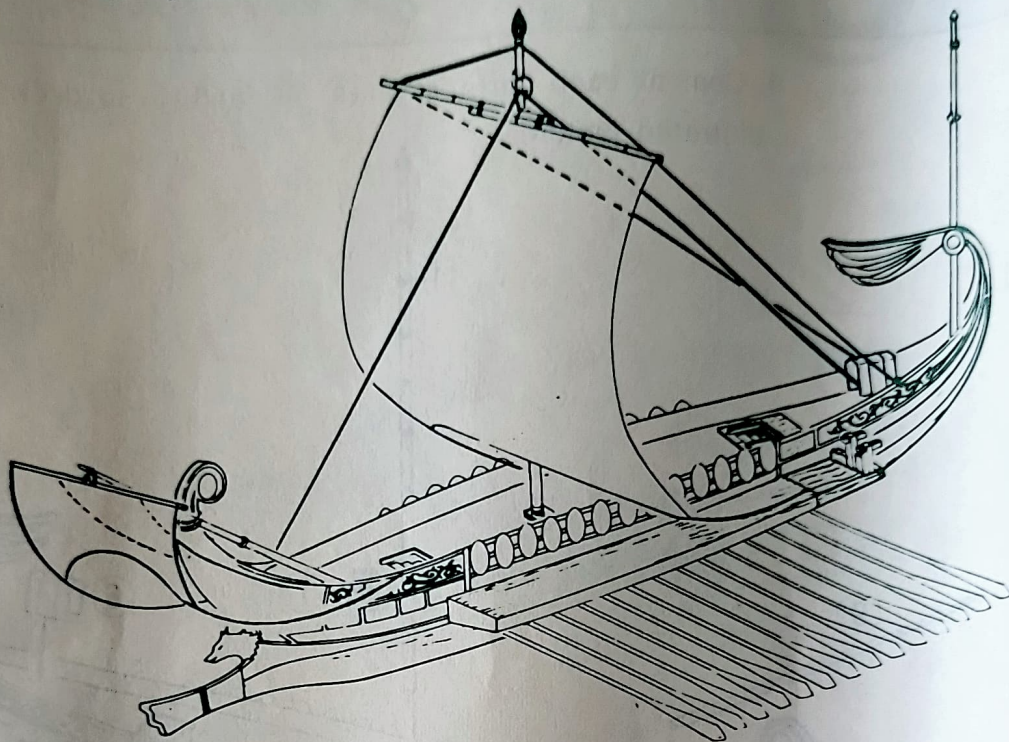

Make pin hole on sail by pin vise.

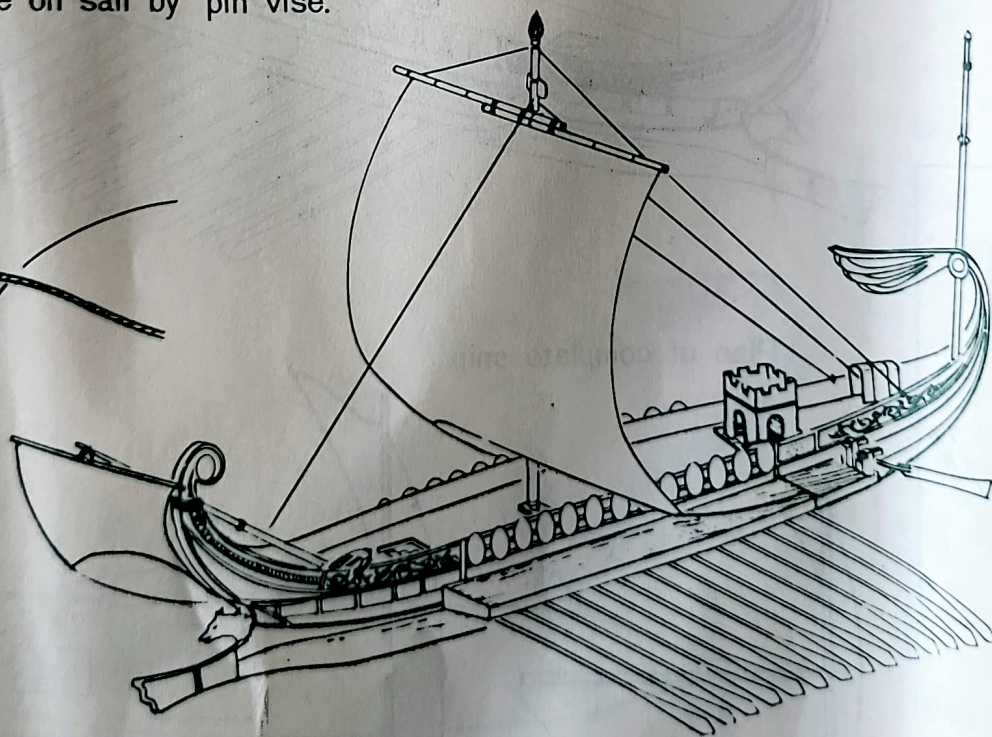
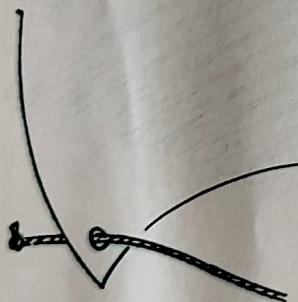

COLOR INSTRUCTIONS

We suggest you special color instruction for your ship.

Spray ship's body and sail all over with golden spray lacquer for plastic model.

Paint support stand with brown lacure for plastic model.