

The Moon Bus

Photoetched Enhancements

Instructions V1.3



INTRODUCTION

Thank you for purchasing ParaGrafix's photoetch set for the Moebius Models Moon Bus (or classic Aurora kit). This set will add new accuracy and detail to the classic Moon Bus model.

If you are unfamiliar with photoetch, please see our primer at: <http://www.paragrafix.biz/instructions.asp>.



#2001-1
Or Classic Aurora Kit

Materials

In addition to the photoetch, you will also need scissors or a knife* to remove individual pieces from the main fret, a file to remove material left from cutting, and super glue (aka CA or cyanoacrylate). Additionally, to fold some pieces, you will need a pair of razor blades** or a specialty tool such as an Etchmate 3C from Mission Models.

* We prefer a #17 Xacto chisel blade.

** Extreme care must be taken when using razor blades. Risk of serious injury.

Raised Detail

 Where applicable, these instructions note an area where the raised kit detail must be removed. The symbol at left will show you where this needs to happen. This may be done in whatever way you are most comfortable: sanding, filing, chiseling. Note that in most cases the surface does not need to be perfectly smooth as the photoetched part will replace the "lost" kit detail.

Über-Detailing

 We've included special instructions for addition / enhancing detail not available simply using the photoetched parts. Look for the Über-Detailing Symbol.

Key

Kit part (plastic): 

Photoetched part: 

Installation Parts Order

The installation steps are not in any particular order. You can complete them as you see fit to complement your kit construction order.

Window Frames

Install "Glass"

Install the kit glass parts per instructions.

 Replace the kit glass with clear sheet plastic from your local hobby store. This will provide a clearer view into the interior.

Attach Window Frames

The window frames are designed to fit in specific locations based on the locations of the "roof padding" pieces (kit parts 46). In addition to being noted on the photoetch fret, the specific part numbers are also listed on their backsides.

 "Beef" up the ribs between the windows to extend out a bit from the windows.

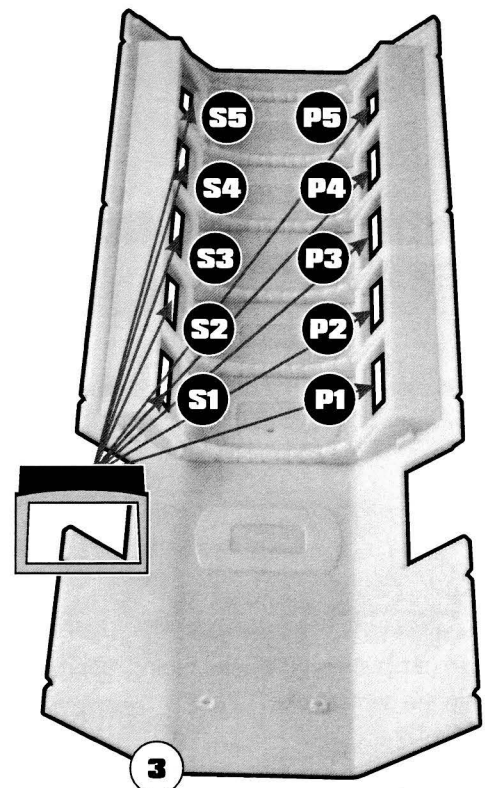

Side Window Grab Handles

Non-Über-Detailed

Note that the included grab handles (17) are sized to be used with the Über-Detailing tip. If you are not going to remove the window ledge lip, shorten the handles by about 1/8" (about 3mm) and you will not be able to use the drilling guide, 21. Tip: You can use the attachment tabs as a rough measuring point.

Drill small pilot holes (about 0.025", 6mm) on the horizontal surface of the window alcoves to accept the attachment nubs. Glue the grab handles in place as shown.

Über-Detailed

 Remove the lower window ledge lip from both window alcoves. Use the drilling guide, 21, to drill pilot holes (about 0.0025", 6mm) on the down ledge and vertical frames, then glue grab handles in place as shown.

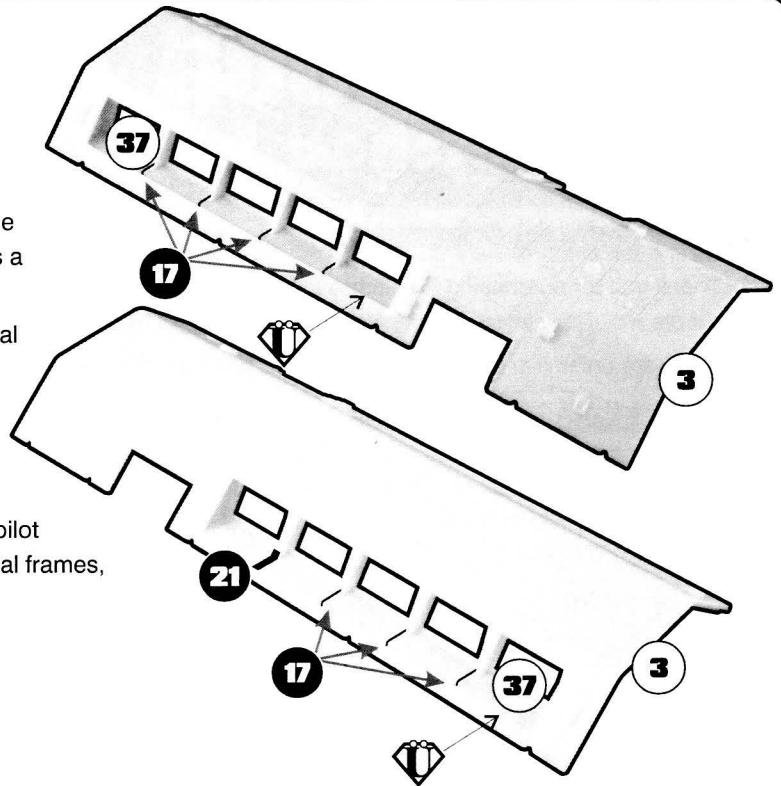

Inner Cockpit Details

Add the upper consoles (6 & 7) and checklist racks (5) as shown.

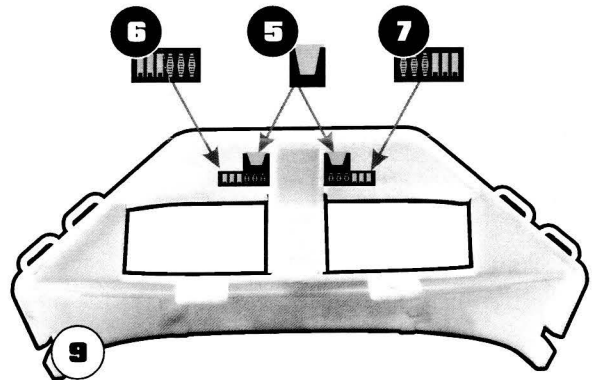

Outer Cockpit Details

Upper Details

 Remove the raised detail above the cockpit windows.

Fold etch piece 10 as shown and mount to the hull as shown. This piece should be hollow.

Attach both etch pieces 8 as shown.

Lower Details

 Remove the raised circular detail below the cockpit windows.

Replace with either etch parts 3A or 3B. If using 3A, add short sections of 0.06" (1.5mm) diameter tubing, approximately 0.06" (1.5mm) long into the center hole.

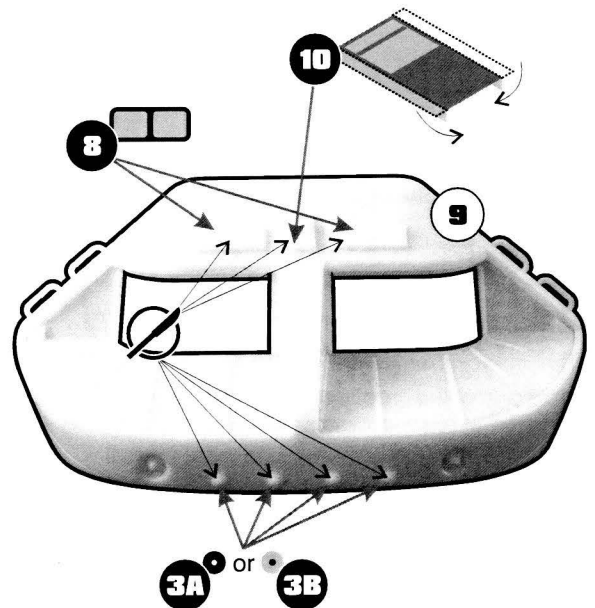

Front-Side Details

Etch parts 9 replace kit parts 42.

 If you will be gluing the roof panel (kit part 3) to the body, you will find it easier to fill the seam if you remove the kit's grab handles. Replace them with etch parts 18.

TIP: use drilling guide (19) to help properly position mounting holes.

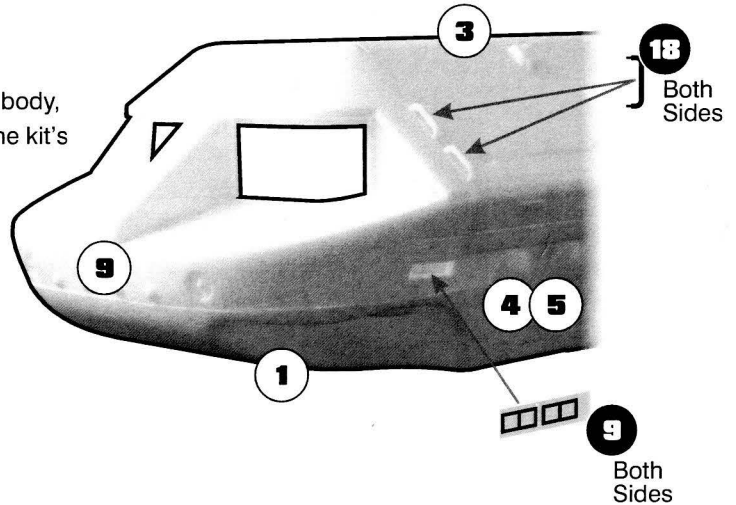

Hi-Gain Antenna

The photoetch for this part can be added either before parts (29) and (30) are assembled, or once the antenna parts are put together. We suggest assembling the antenna before removing the kit detail and adding the photoetch as it will be easier to handle.

Use a small diameter pencil or other, similar round object to form the antenna reflector (1) as shown. Insert the antenna leads (2) into the reflector as shown and glue in place.

 Remove the antenna leads from kit part 30 as shown and replace with etch assembly 2/3.

There is a small attachment tab on the end of etch part 2. For added stability you should drill a small hole in the face of the kit antenna to accept this tab - if you don't, then snip the tab from etch part 2.

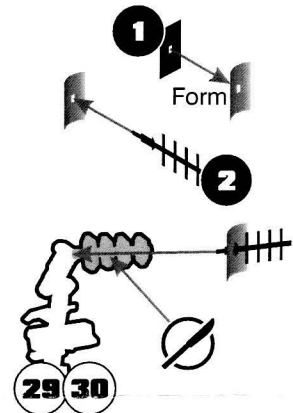

Sidewall Details

Add the sidewall details (16) as shown on both sides. You can leave the original kit detail in place if you'd like.

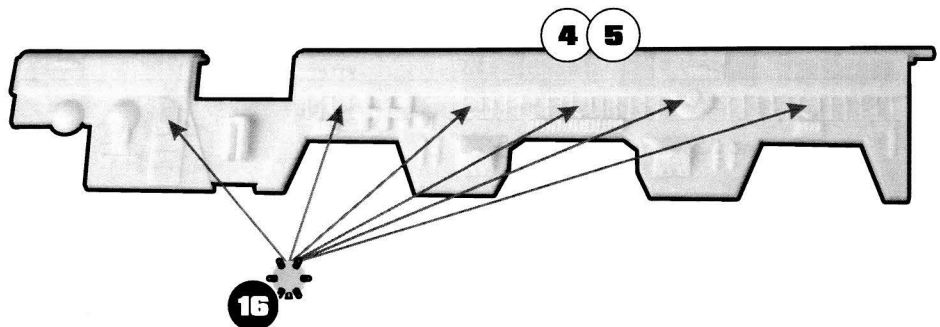

Rear Bulkhead Details

Rear Grates

 Remove the raised kit grills and replace with etch parts 13 and 14. Note that the etch grills will leave a small amount of space behind them and shown in the close-up cross-section.

Grab Handles

Carefully bend* the upper portion of etch pieces 20 to follow the curve of the hull as shown by the thick gray lines. Glue the handles into position with the "legs" attaching in the locations shown.

* You might find it easier to bend the pieces if you anneal them first. Please see our generic PE instructions for more information.

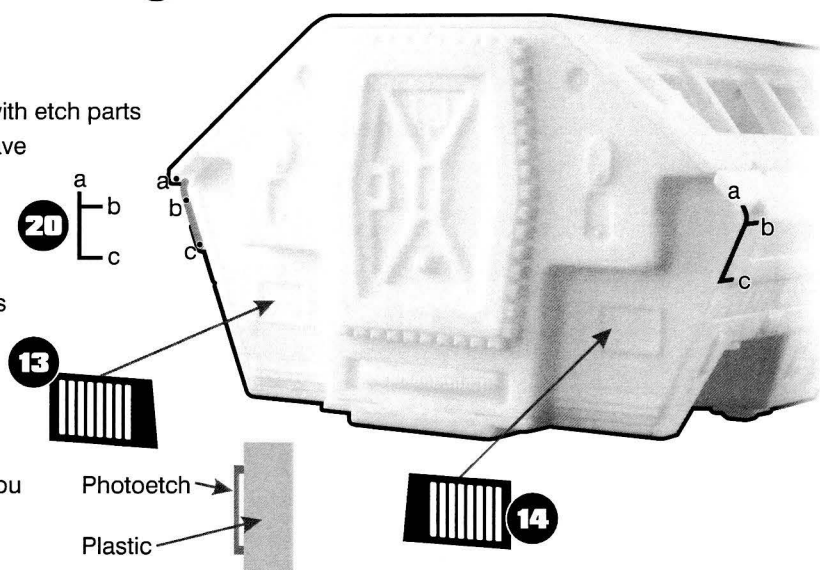



Side Detailing

Roof Gap Strips

Replace kit parts 19, 20, and 43 with etch parts 4, 11, and 12. Note that these parts will be more delicate than the plastic parts included in the kit, so you must be very careful if you decide to make the roof removable.

RCS Thruster ("Bay") Top Details

 Remove the fine lines from the tops of both kit "bays" (parts 13 and 14) and replace with etch parts 15, six on each side.

 There should not be frames on the roof (3) where it meets the "bays" (parts 13 and 14). Remove this raised framing.

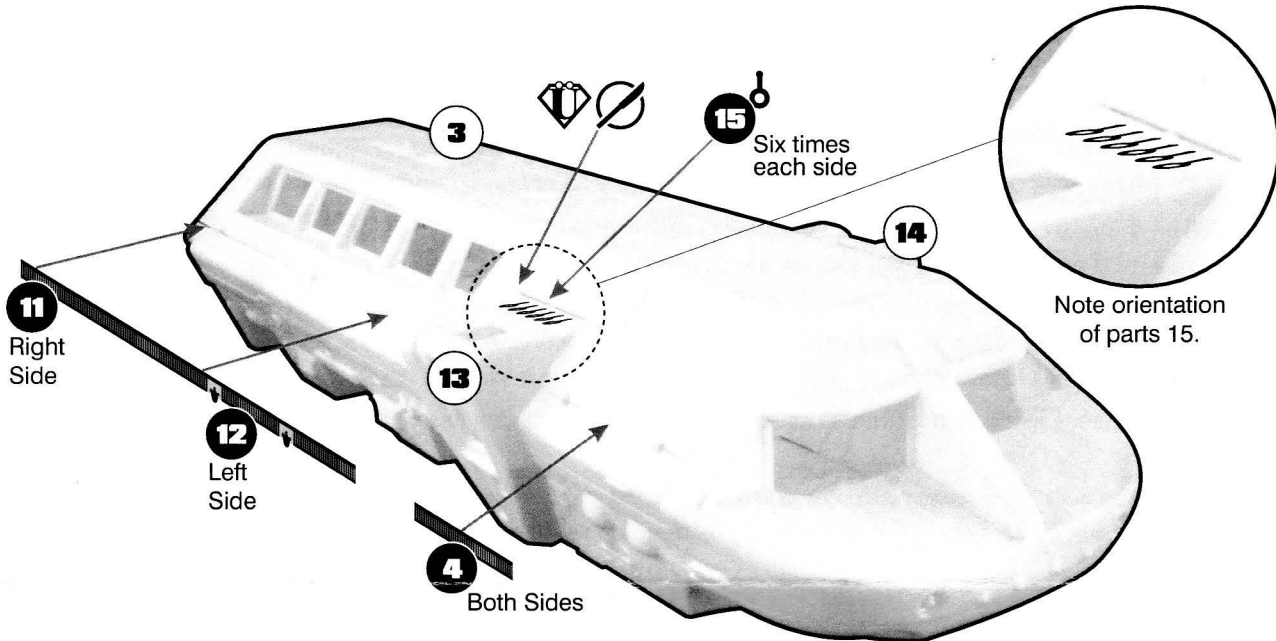

Rocket Nozzle Piping

 Remove the raised detail from the engine nozzles (kit parts 51 and 52).

Mark and drill 10 small pilot holes equally spaced around the engines.

TIP: Use the template below to correctly position the holes at equal angles about the engines. (You can photocopy the template if you want to use separate ones for each engine and/or to guard against damage.)

Glue the five pipes into each engine as shown.

Note that there are five sets of pipes, but there were only four pieces of raised detail.

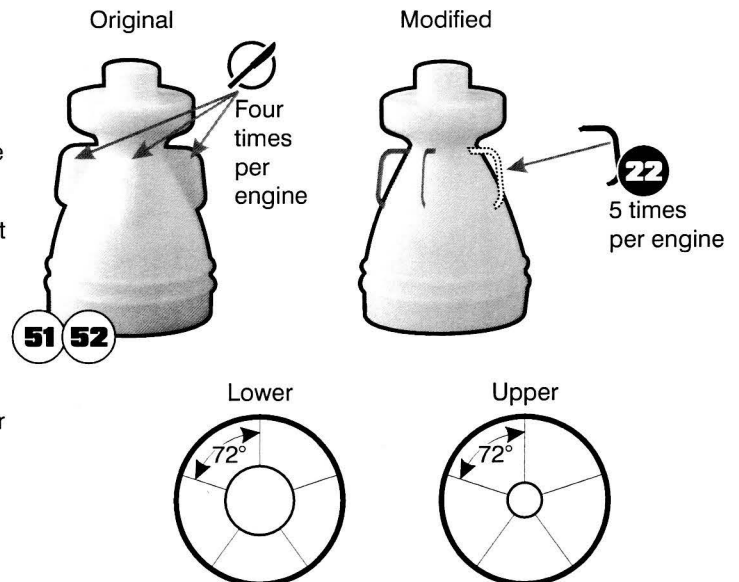

**PARA
GRAFIX™**

148 Rocklawn Ave.
Attleboro MA 02703 USA
+1 508-431-9800
www.ParaGrafix.biz

ParaGrafix™ and PGMS™ are TM Paul H. Bodensiek. All Rights Reserved.
Moebius® is a registered Trademark of Moebius Models. All Rights Reserved.

Thank you to Frank Winspur and Dave Metzner of Moebius Models for providing us with a pre-release copy of this kit so that we could have our photoetch set available when the Moon Bus hits store shelves.

Thank you to Scott "Captain Cardboard" Alexander for his excellent advice and reference help.

