

1/144 SCALE AIRCRAFT SERIES

# YF-22 LIGHTNING II

美国YF-22闪电二式战机

部品图  
(Parts)

A1

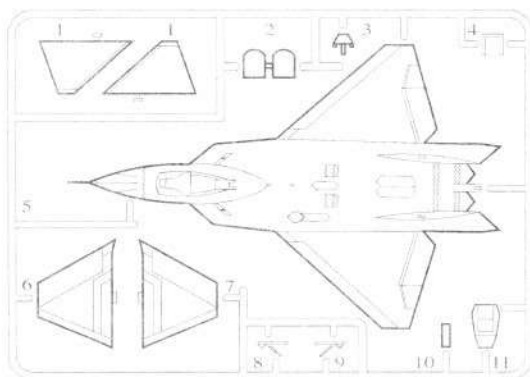

A2

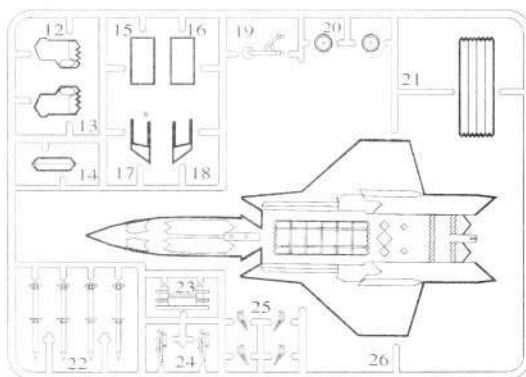

B

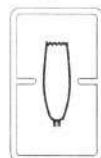

贴纸 (Decal)

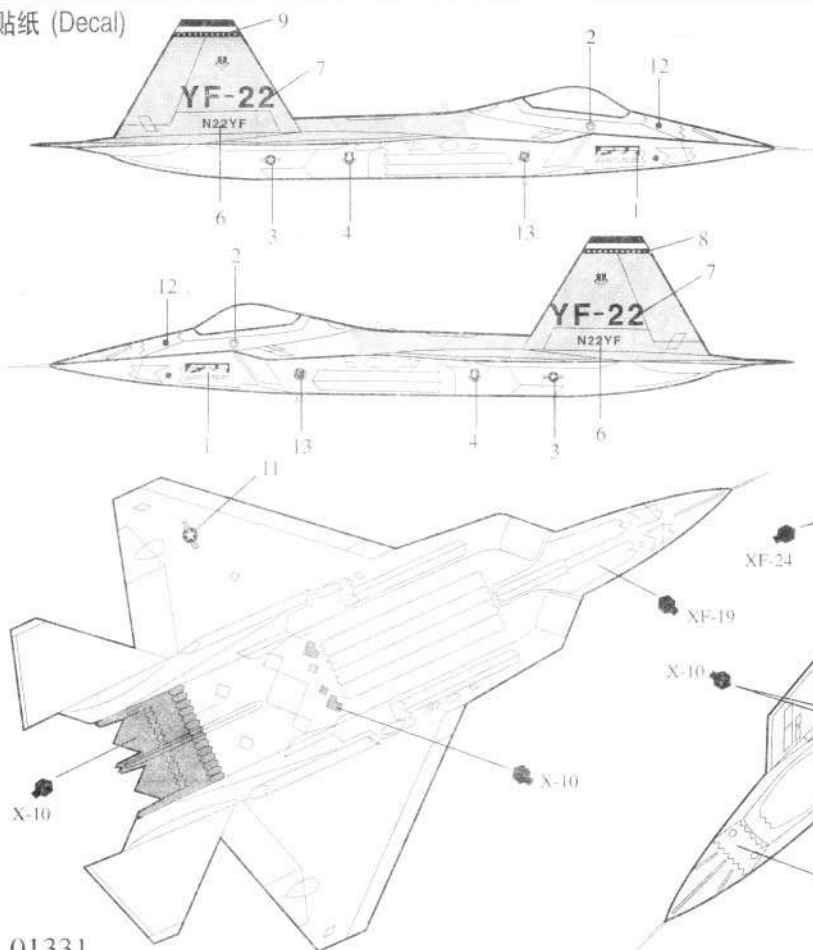

1. 在开始组装你的模型前, 请认真阅读此说明书。
2. 依据安装说明, 用钳子或小刀小心地切割下所需部分。  
Read this instruction sheet carefully before you start to assemble your model.  
Cut the parts carefully in accordance with the assembling order by use of a nipper or a knife.

01331

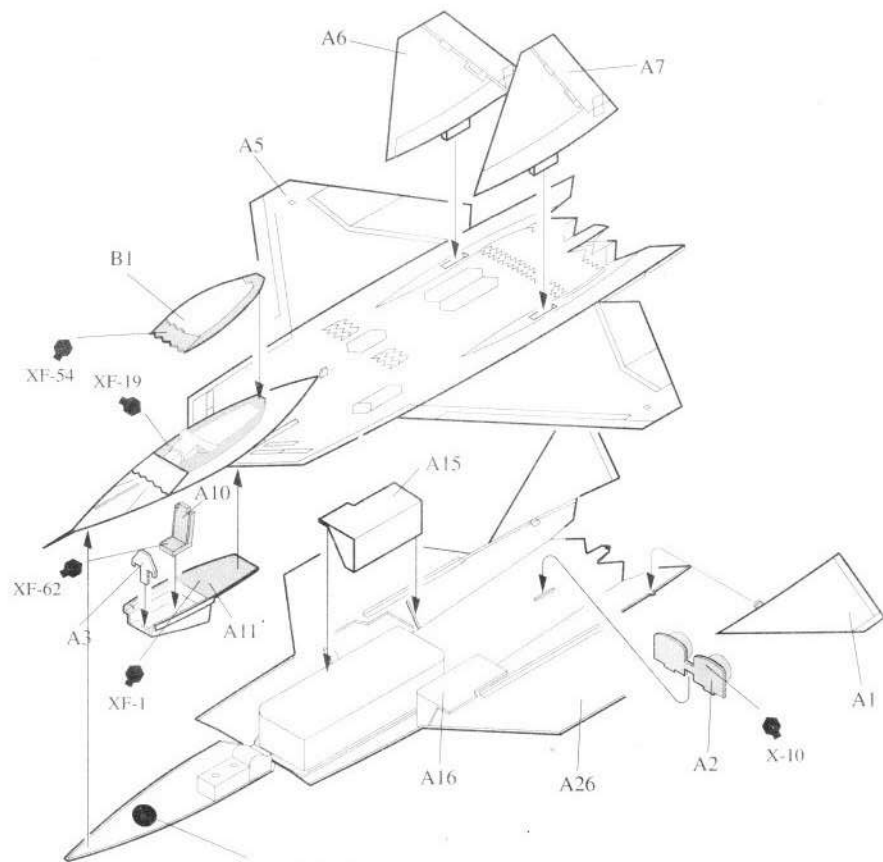

加入配重黏土约10克  
Increase the weight of  
cement 10g

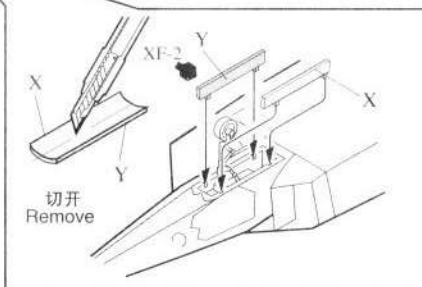
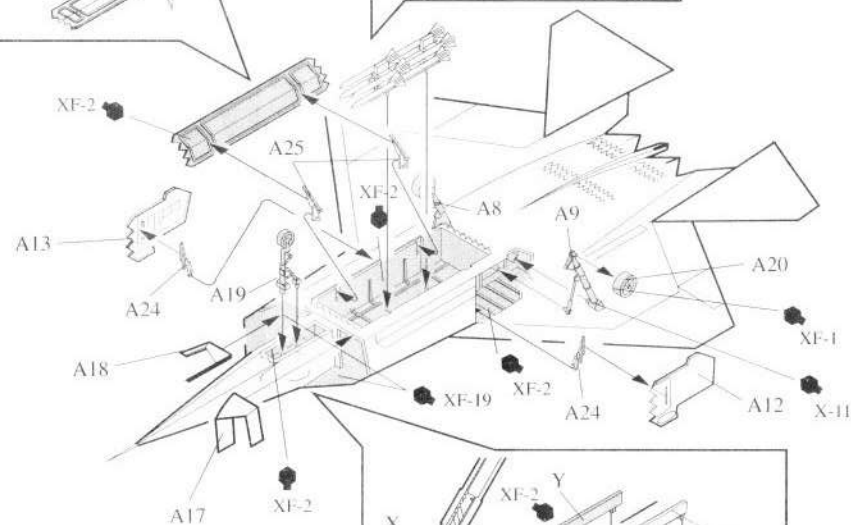
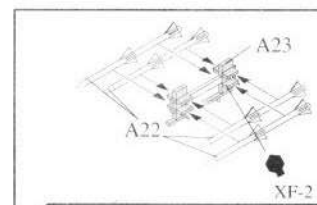
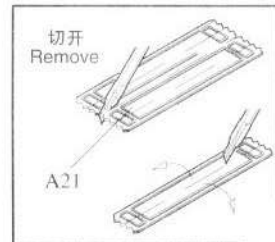

## 颜色指示 COLORS

X-10	炮铜色	Gun Metal
X-11	铬银色	Chrome Silver
XF-1	哑黑色	Flat Black
XF-2	浅白色	Flat White
XF-19	天空灰	Sky Grey
XF-54	中性灰	Dark Sea Grey
XF-62	橄榄褐	Olive Drab

## 水贴纸的使用:

1. 从水贴纸上剪下印花;
2. 将印花放入温水中浸10秒, 然后放在干净布上。
3. 拿着印花纸板将印花移到模型上;
4. 手指蘸水将印花移到适当的位置;
5. 用软布轻压印花直至水下, 气泡消失。

## DECAL APPLICATION

1. Cut off decal from sheet.
2. Dip the decal in tepid water for about 10 sec. and place on a clean cloth.
3. Hold the backing sheet edge and slide decal onto the model.
4. Move decal into position by wetting decal with finger.
5. Press decal gently down with a soft cloth until excess water and air bubbles are gone.