

P-51B "Mustang" Fighter

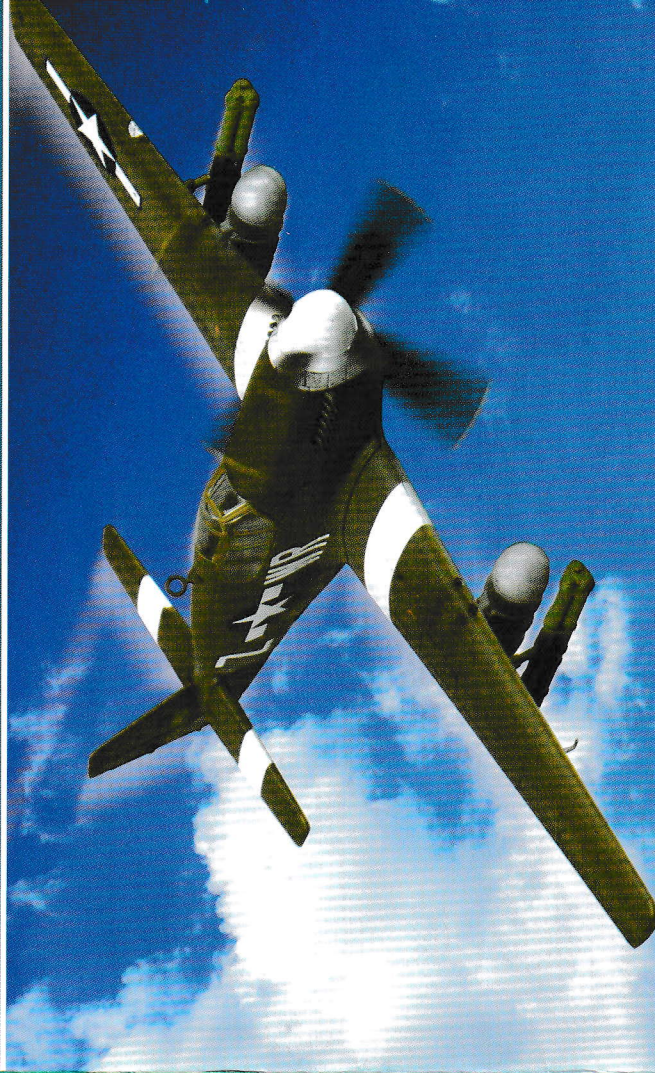

EASY ASSEMBLY AUTHENTIC KIT

-  cyanacrylate glue 强力胶
-  weight 配重
-  make hole 钻孔
-  cut / remove 切除
-  option 选择
-  no cement 不涂胶水
-  decal 贴纸
-  bend 弯曲

水贴纸的使用方法:

- 一 把相关的印花从水贴纸上剪下, 放入40℃左右的温水中浸10秒。
- 二 然后将印花放在干净的布上。
- 三 拿上印花纸版, 手指蘸水将印花移到适当的位置。
- 四 用软干布轻压印花直至水干, 气泡消失。

The way to apply the decals

- 1 Cut off the decal from the decal paper and put it into the warm water 40° for 10 seconds.
- 2 Take the decal from the water and put it on a piece of clean cloth.
- 3 Remove the decal slowly from the paper to the targeted location by a wet finger.
- 4 Use a piece of dry and soft cloth to press it gently on the decal until it getting dry and no bubble existing.

P-51B Was flown by 1st Lieutenant Henry Brown

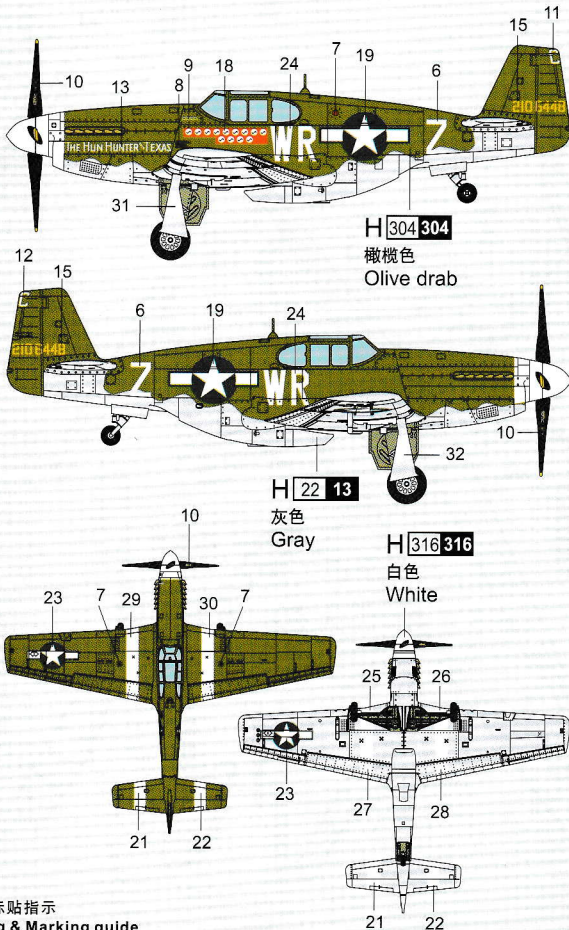

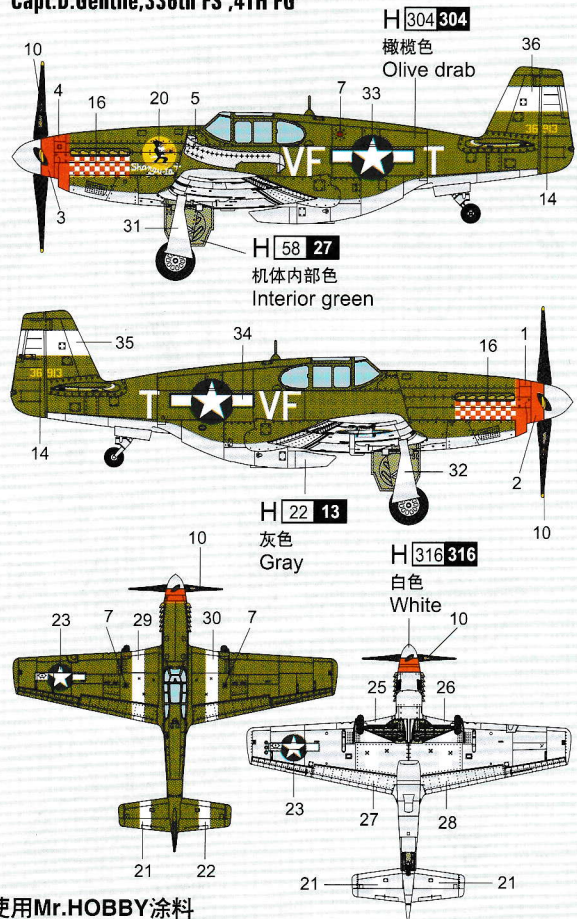

Capt.D.Gentile,336th FS ,4TH FG



涂装同标贴指示
Painting & Marking guide

使用Mr.HOBBY涂料
Mr. Color used

 AQUEOUS HOBBY COLOUR  MR.COLOUR

* Some paints may not be available in your country. Please check your local hobby shop for substitute

部品图 Parts

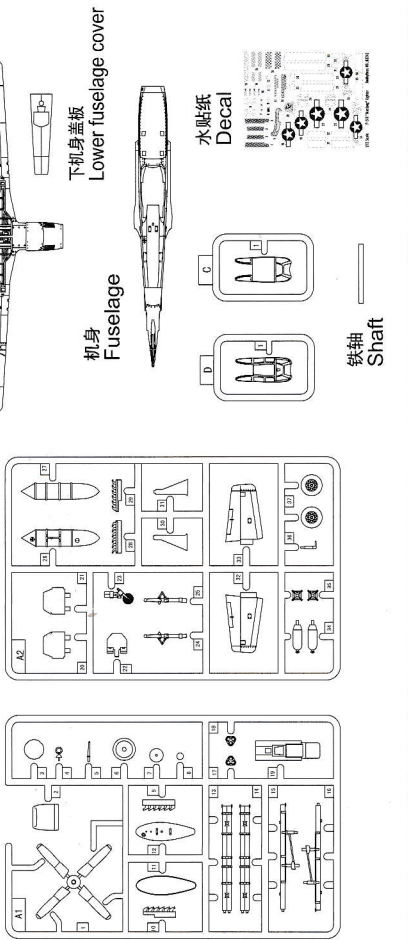

1

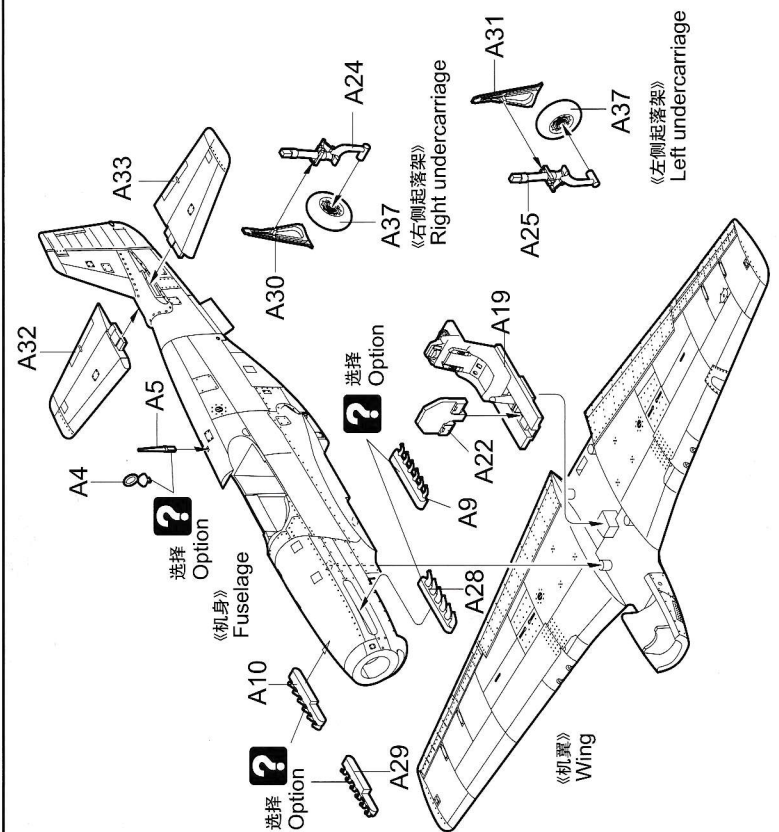

2

