



1/350 摩耶号重巡洋舰改造件（配青岛社009437） PE No. 202304

1/350 IJN Heavy Cruiser Maya 1944 Detail Up Photo-etched For Aoshima 009437



购买：冷泉andD船模工作室（闲鱼）

其他配件，可以参考：

- 1、舷窗：鲸模型NO. 350060 日系舰艇通用舷窗；
- 2、爆雷：鲸模型NO. 350312 金属深水炸弹 / 彩虹RB3545 金属深水炸弹；
- 3、八九式127mm双联装高射炮（带炮盖）：要塞模型3D打印件；
- 4、三联装九六式机枪（环形瞄准具+防盾）：蓝胖子3D打印件；
- 5、双联装九六式机枪（LPR瞄准具）：蓝胖子3D打印件；
- 6、单联装九六式机枪：蓝胖子3D打印件；
- 7、烟雾发生器：蓝胖子3D打印件；
- 8、金属主炮管：ssmodel/Master 203金属主炮。

注意：

- 1、板件船首和船尾线型和蚀刻片甲板零件有考证误差，需做填缝处理；
- 2、12m内火艇和11m内火艇建议采用田宫78026 1/350舰载小艇套件；
- 3、零式水侦建议采用柚子模型3D打印件，或长谷川1/350水上飞机套件；
- 4、本改件根据各种考证资料设计，与部分板件零件设计思路不合，请根据需求自行考虑是否替换原板件零件；
- 5、本改件制作难度较大，请多假组测试后再安装；
- 6、所有穿线均为0.1mm；
- 7、N15和N16为可选安装零件，部分考证资料认为摩耶1944没有这2个外延的平台，仅保留射击指挥所。

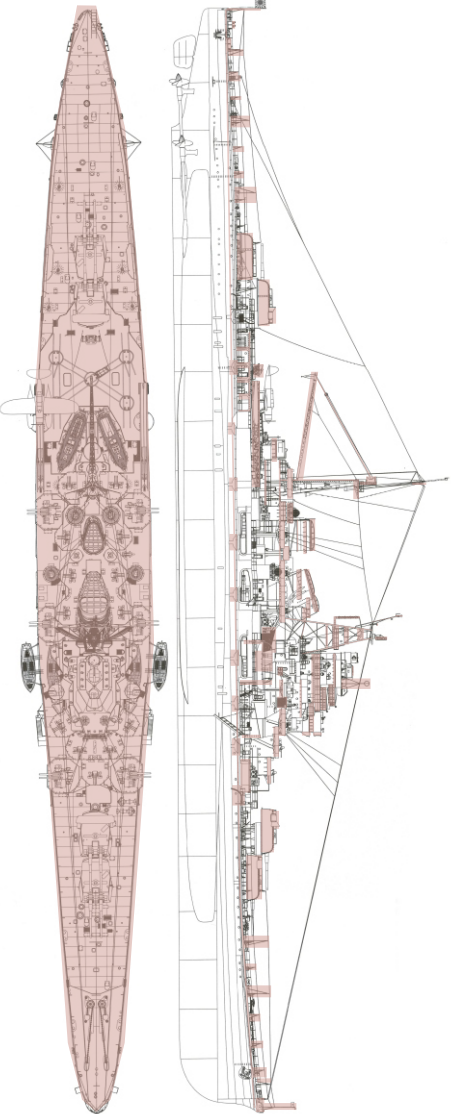

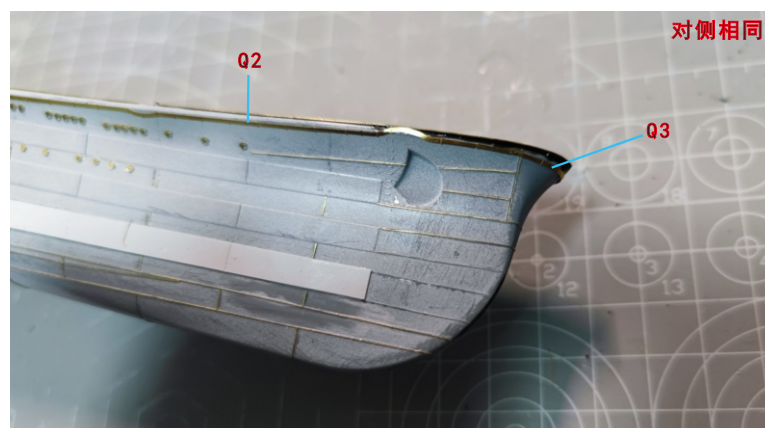
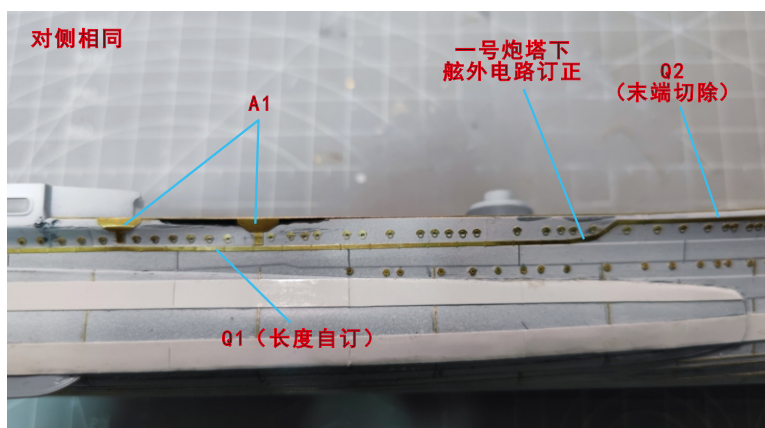
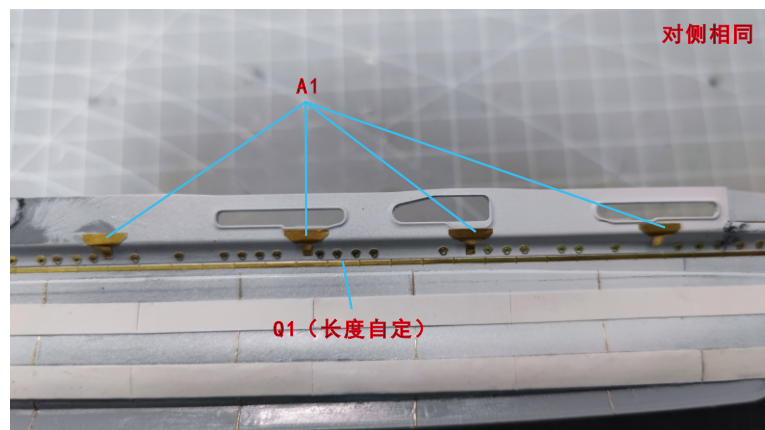
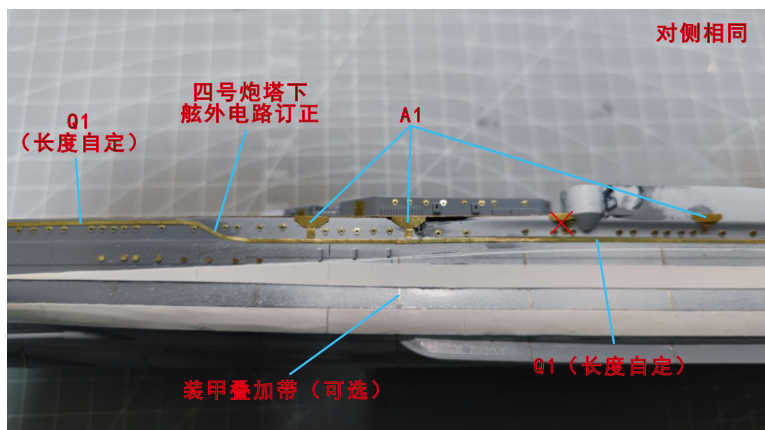
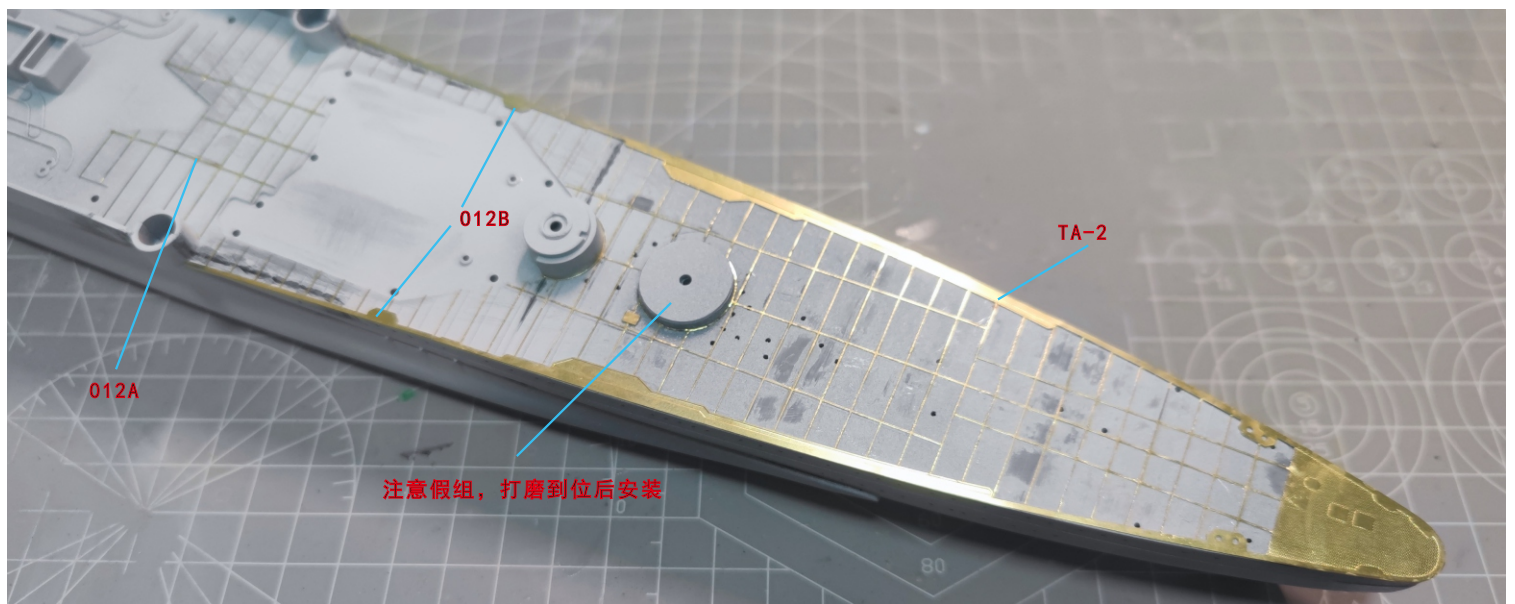
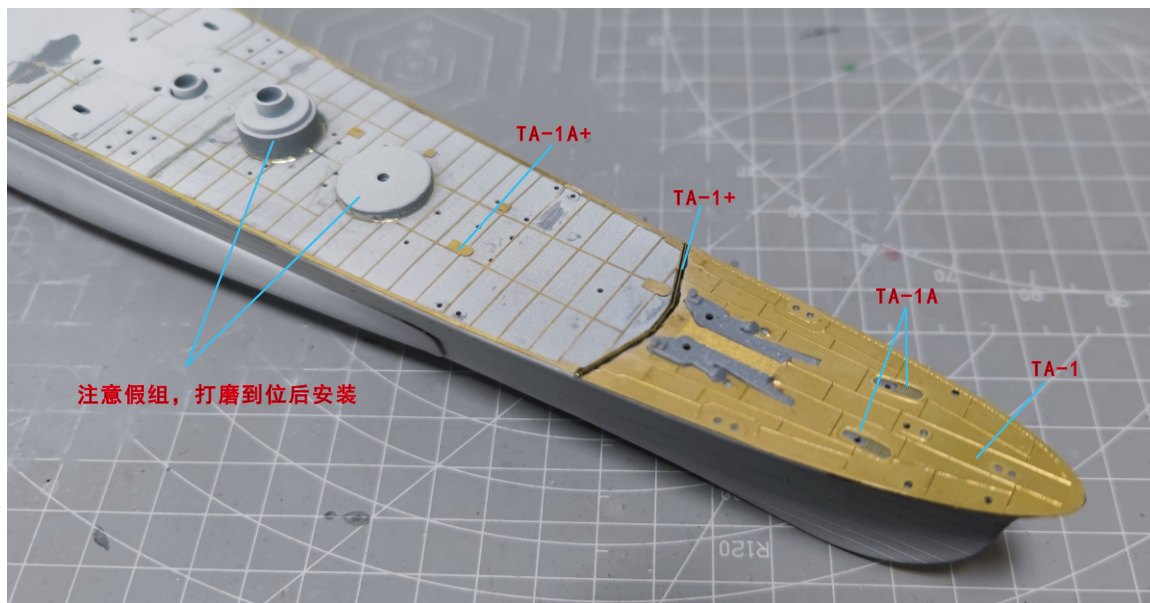

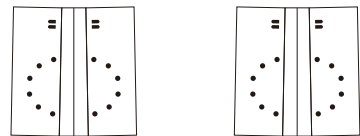
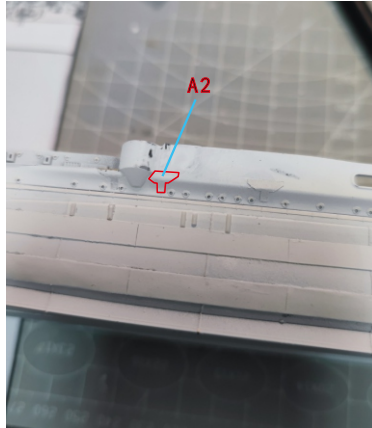
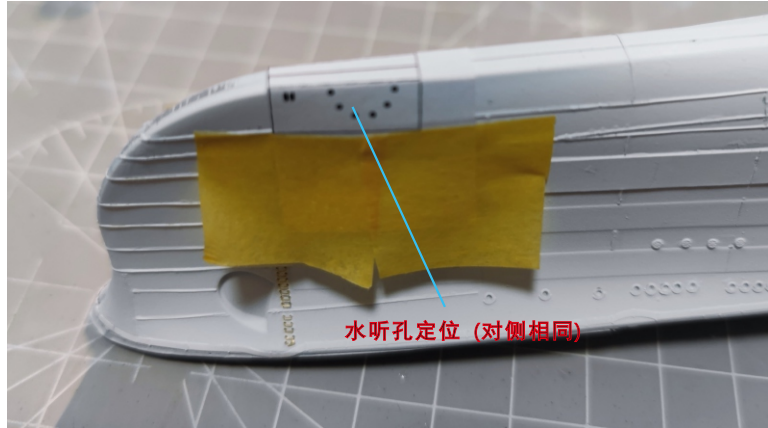

水听孔定位 (1:1)

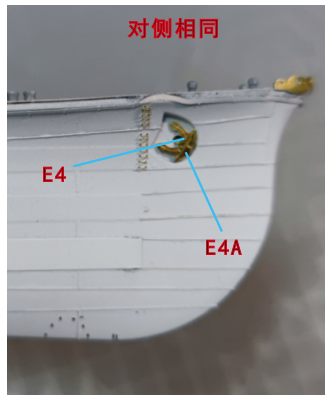
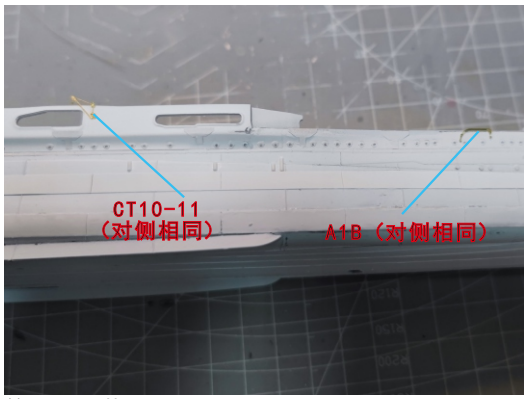
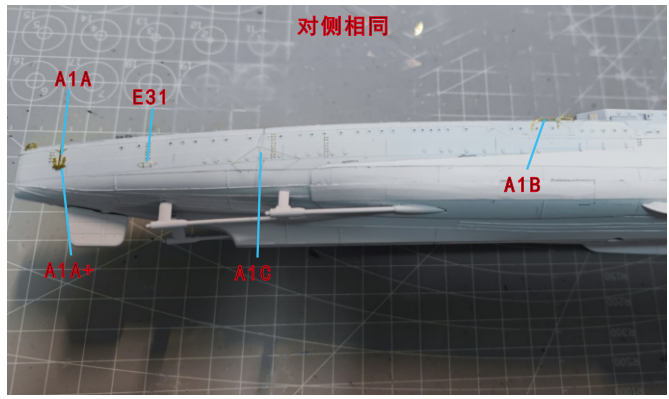
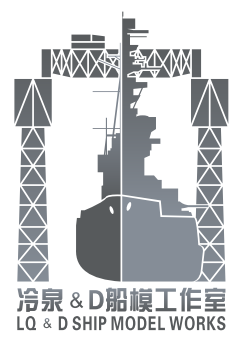
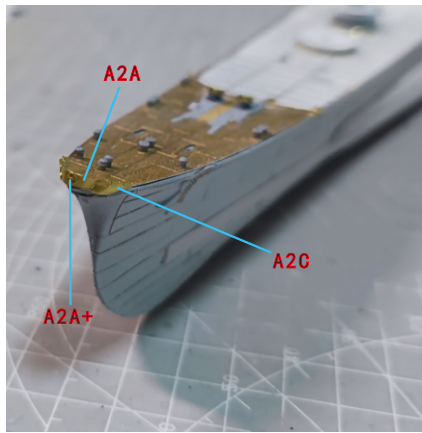
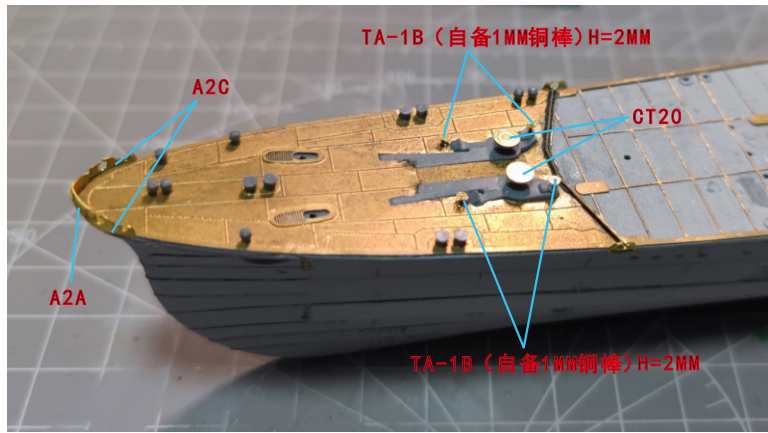
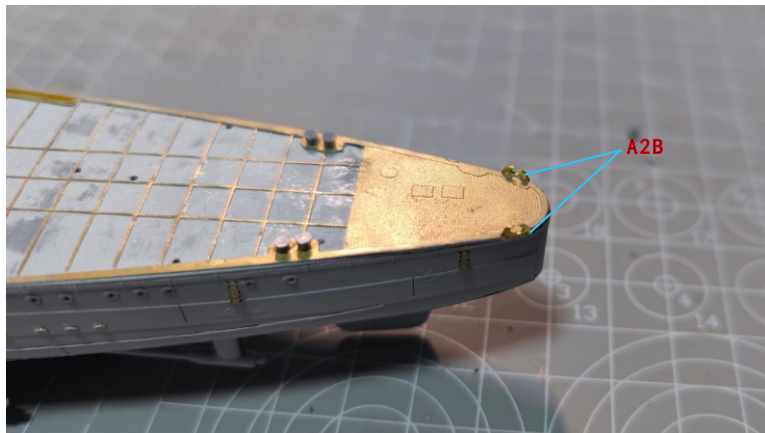
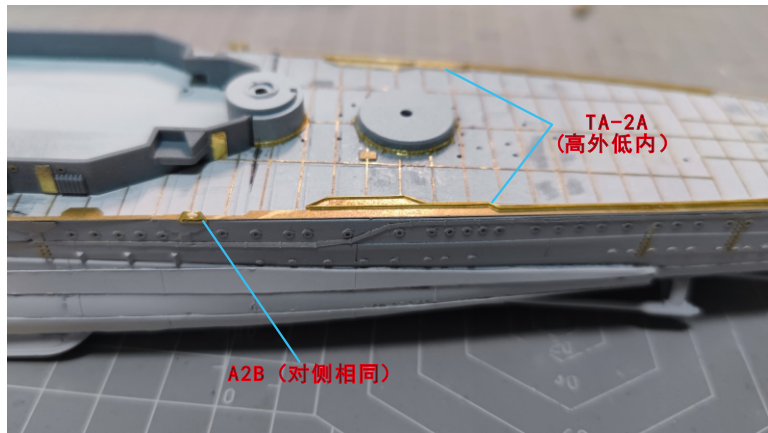
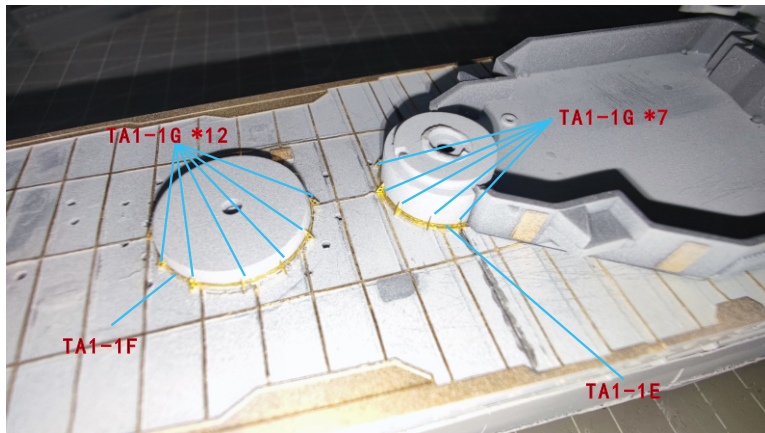
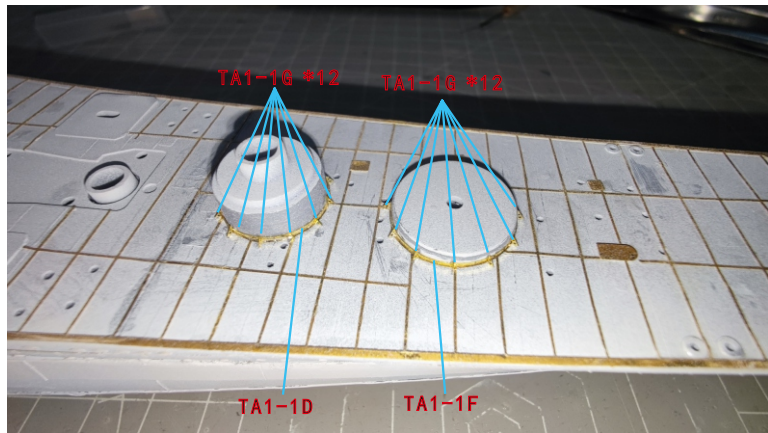
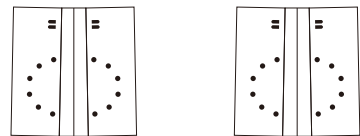

一、二、三号主炮



侧面突出部分需磨平
(对侧相同)

一、二、三号主炮



一号主炮

(板件两端突出部分切除)



一号主炮



一、二、三号主炮

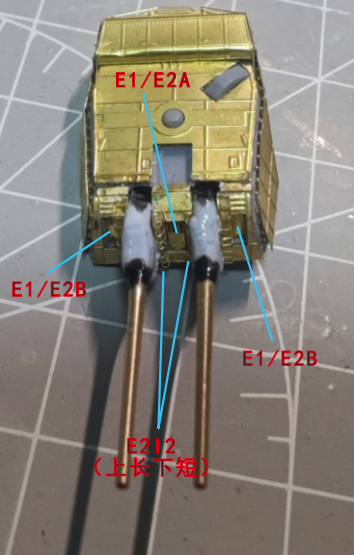

一、二、三号主炮



四号主炮

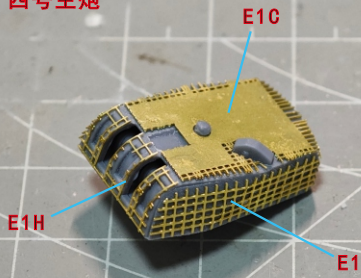

四号主炮

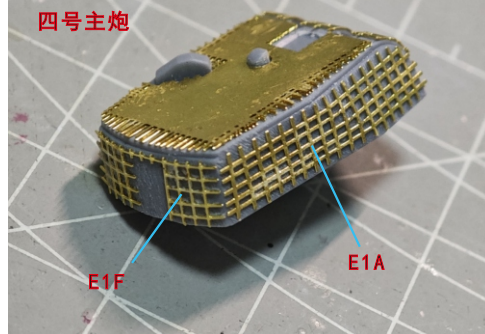

四号主炮



四号主炮



四号主炮

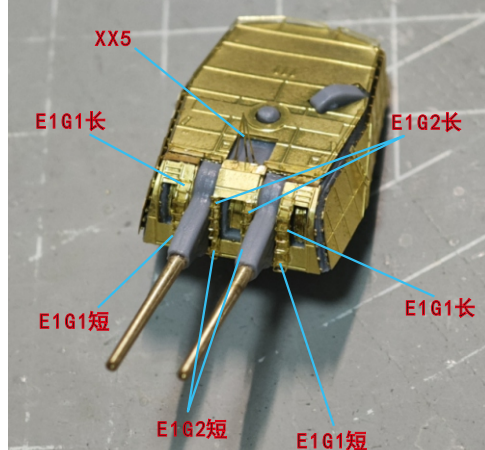

四号主炮



四号主炮

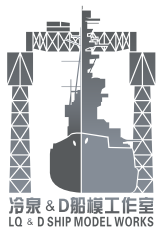

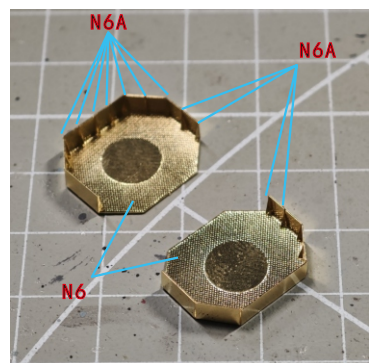
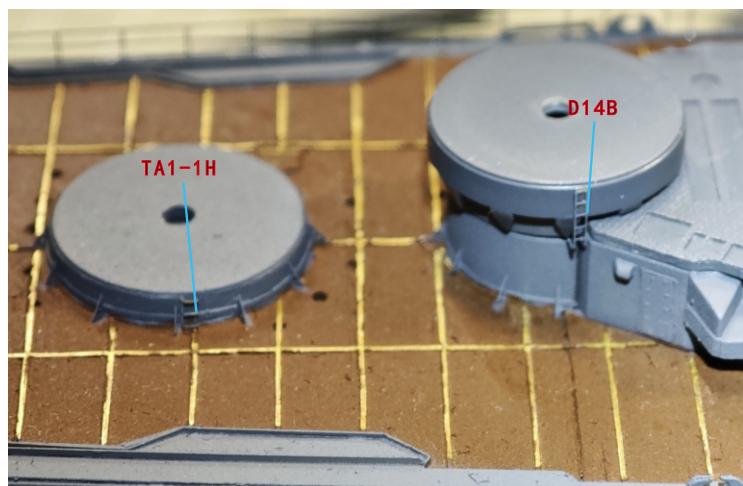
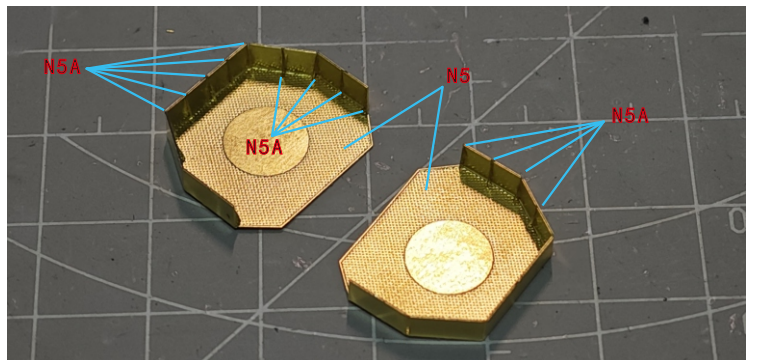
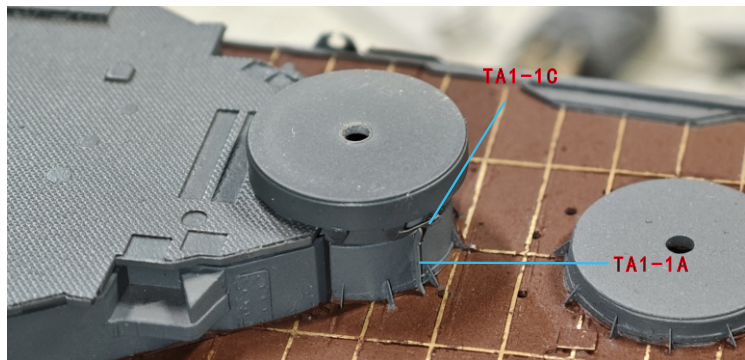
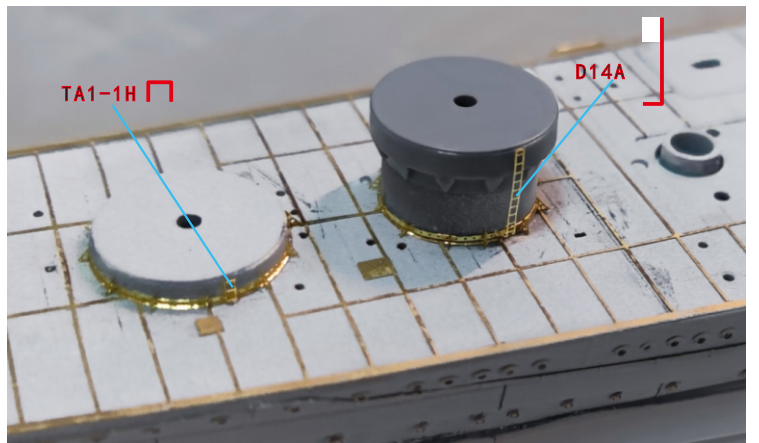
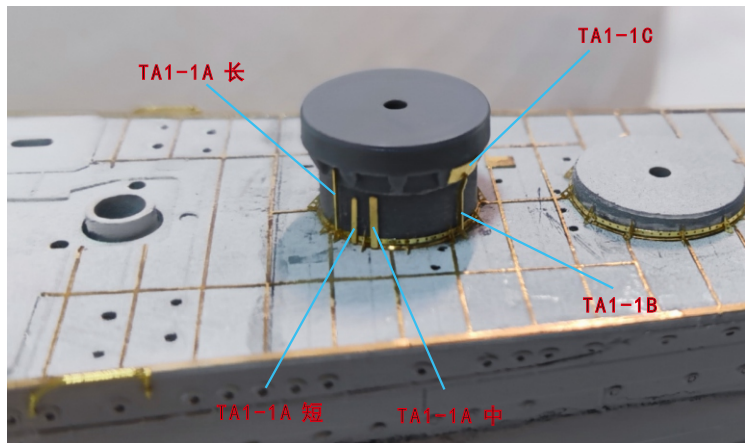
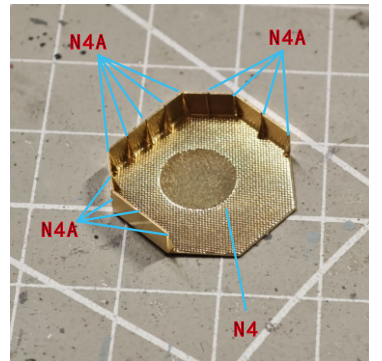
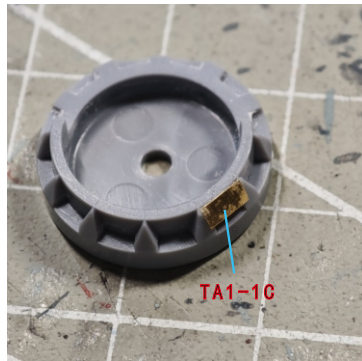
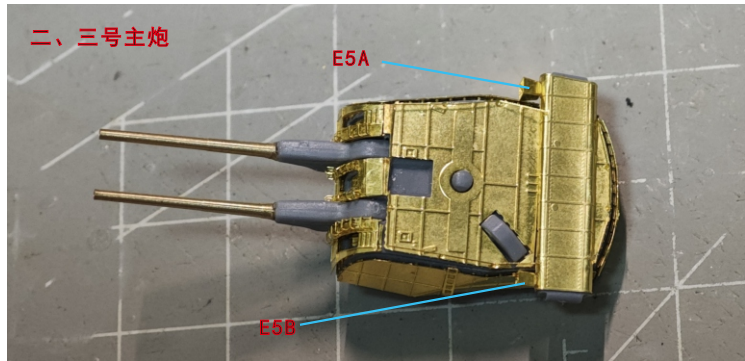
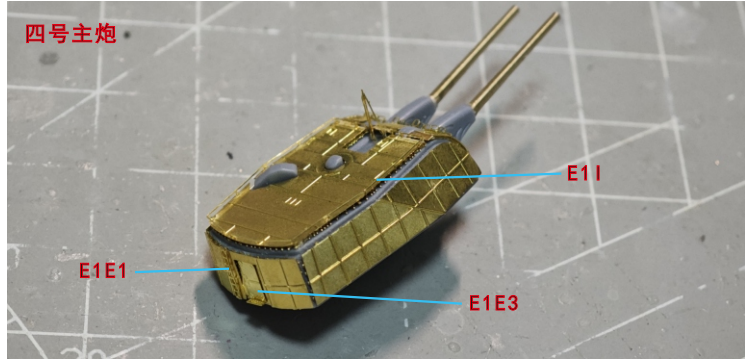

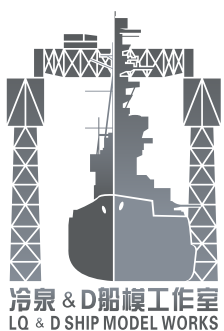
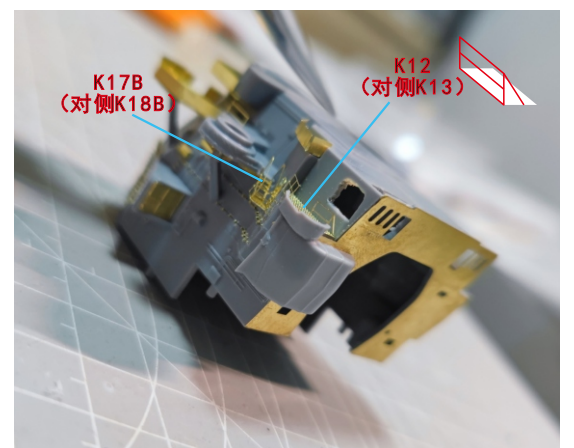
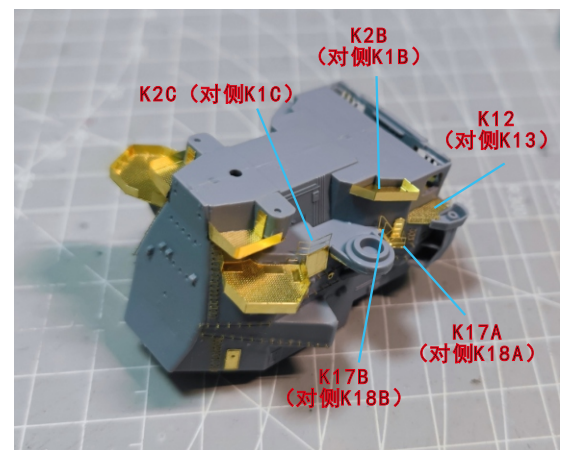
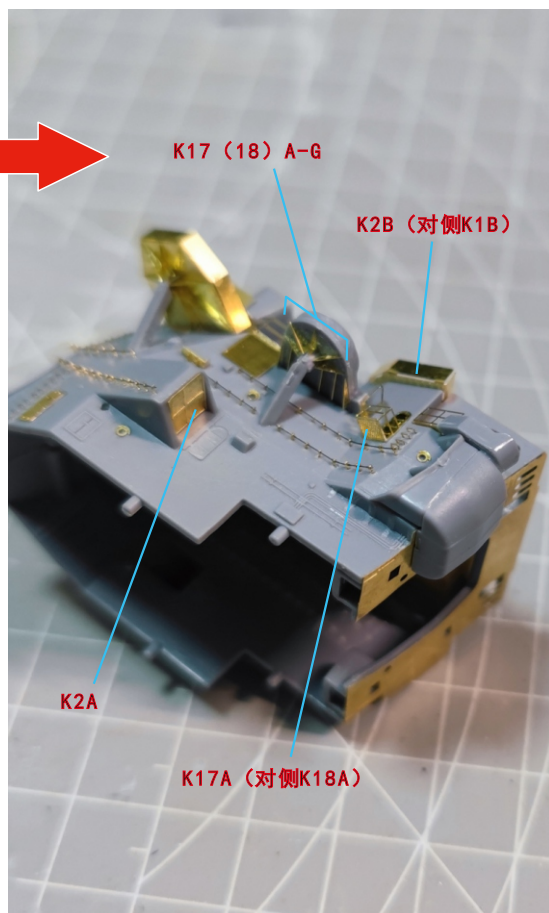
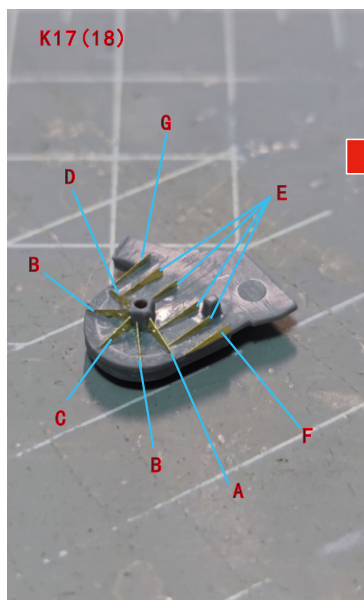
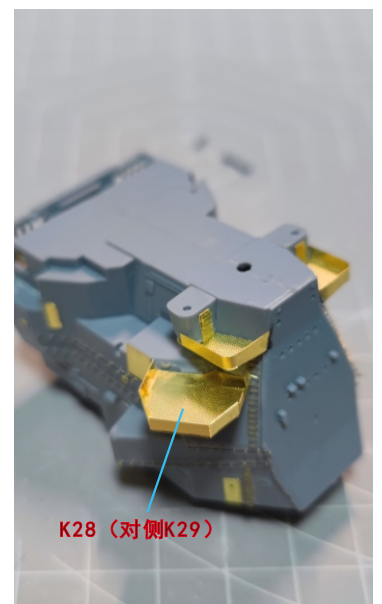
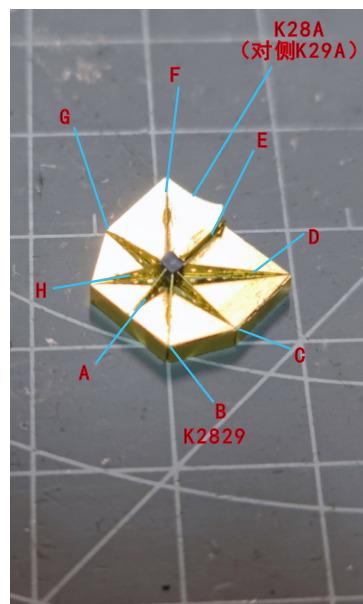
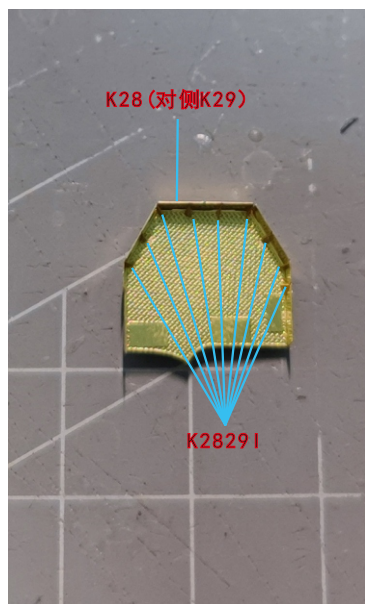
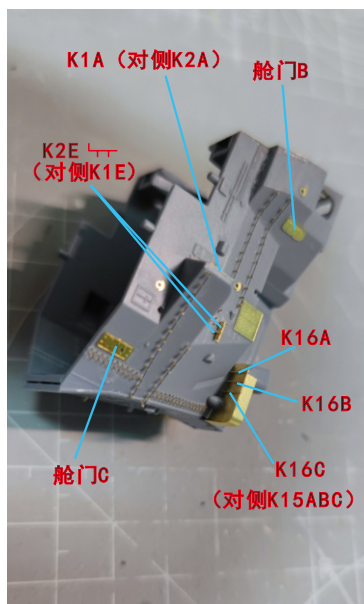
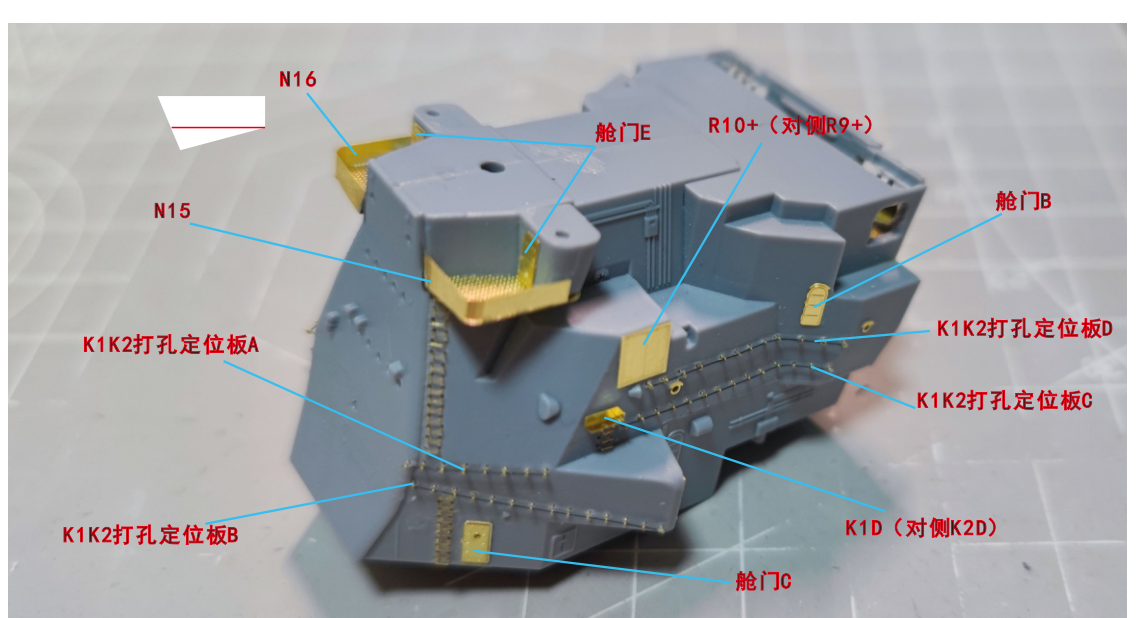
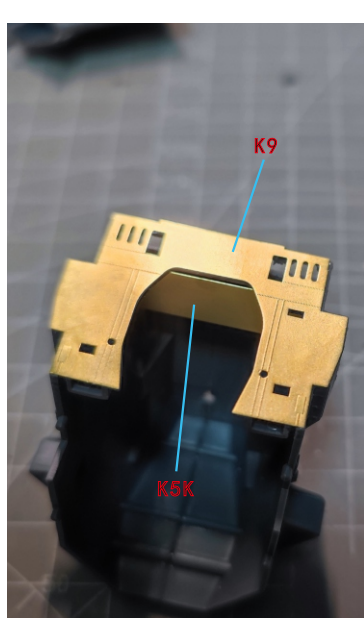

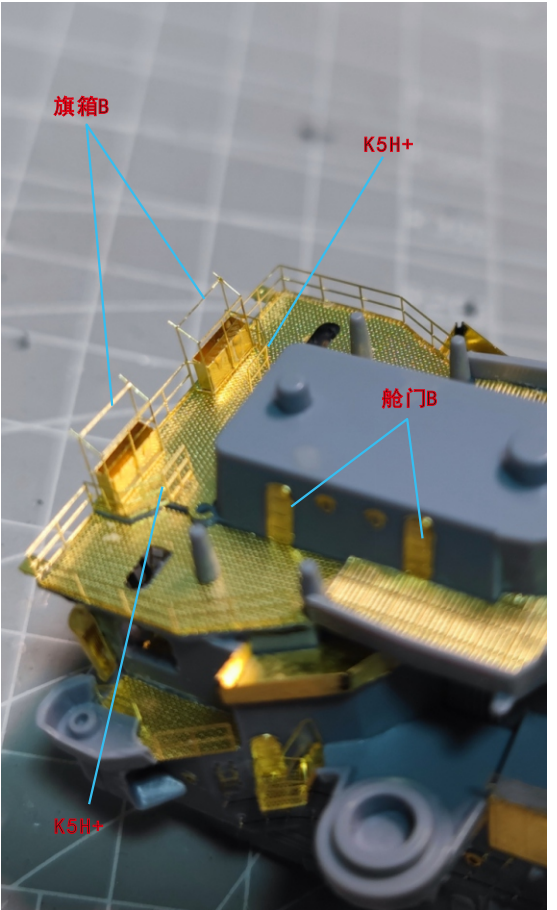
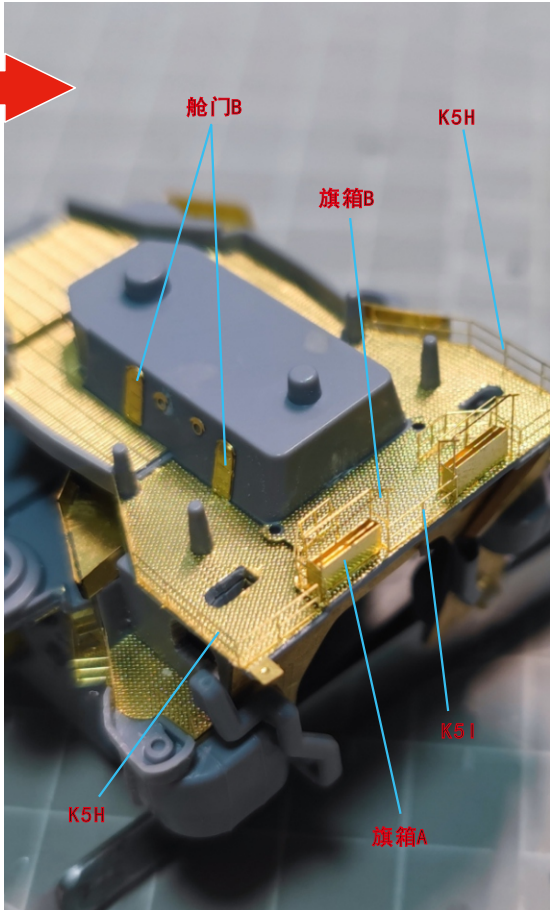
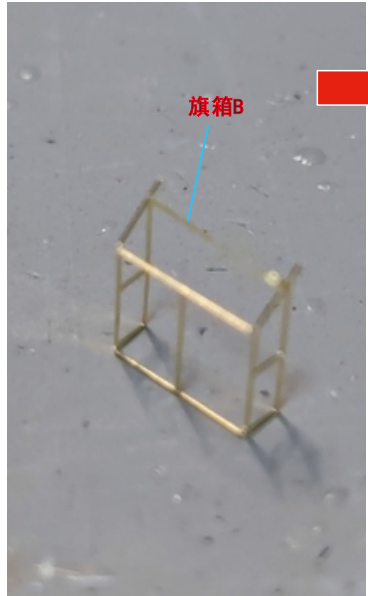
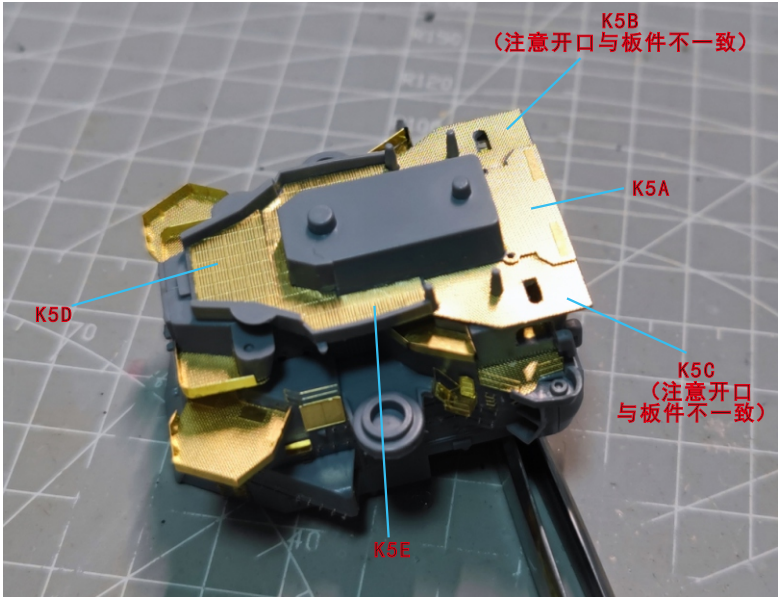
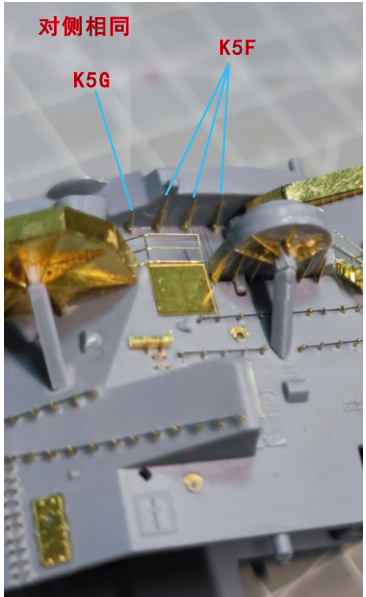
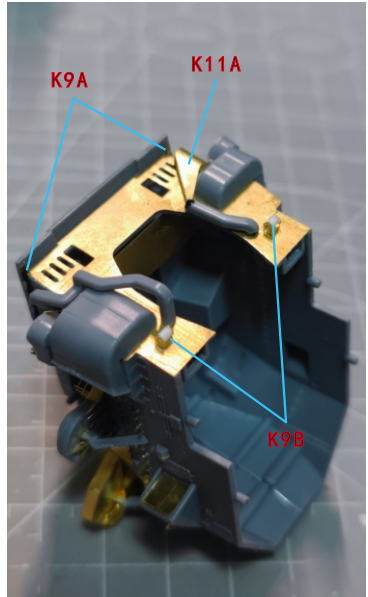
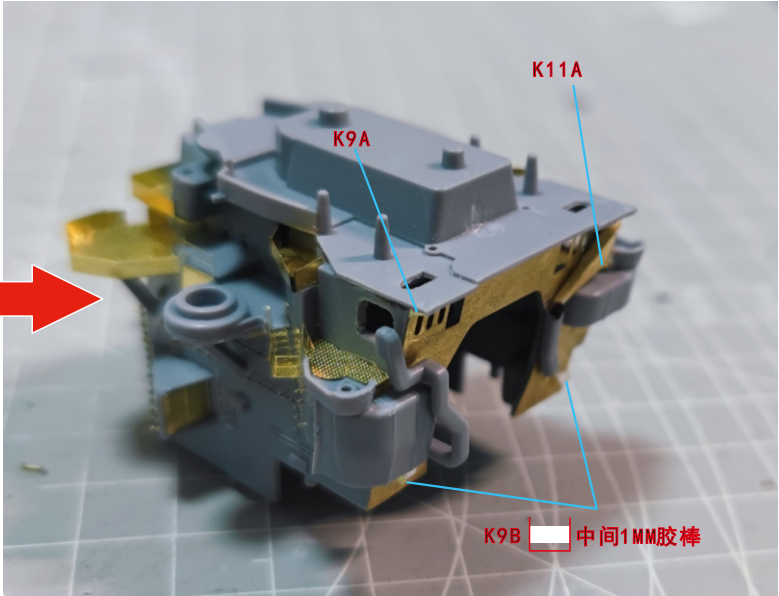
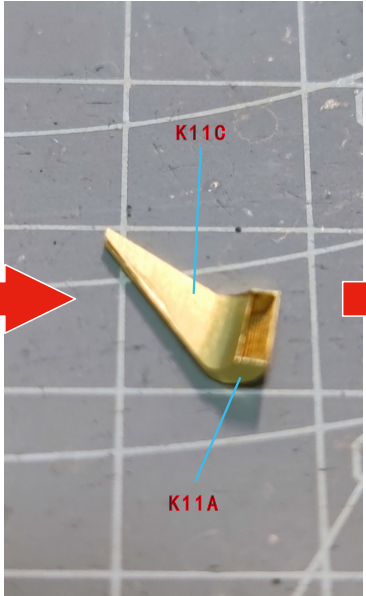
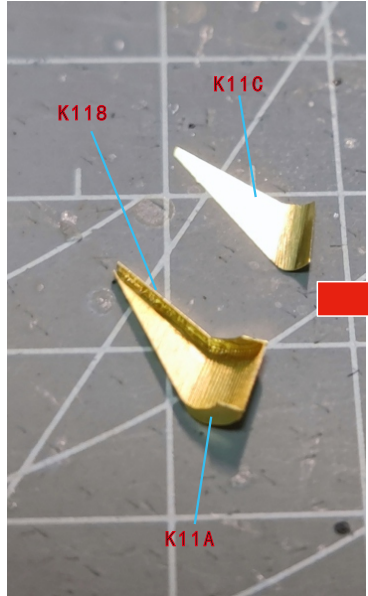

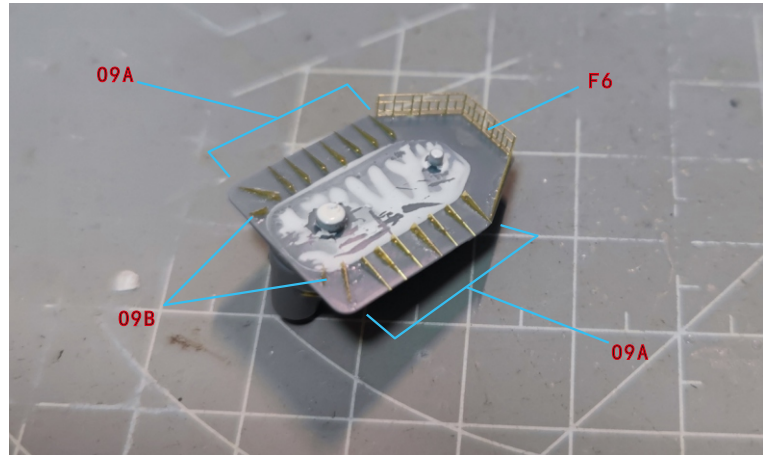
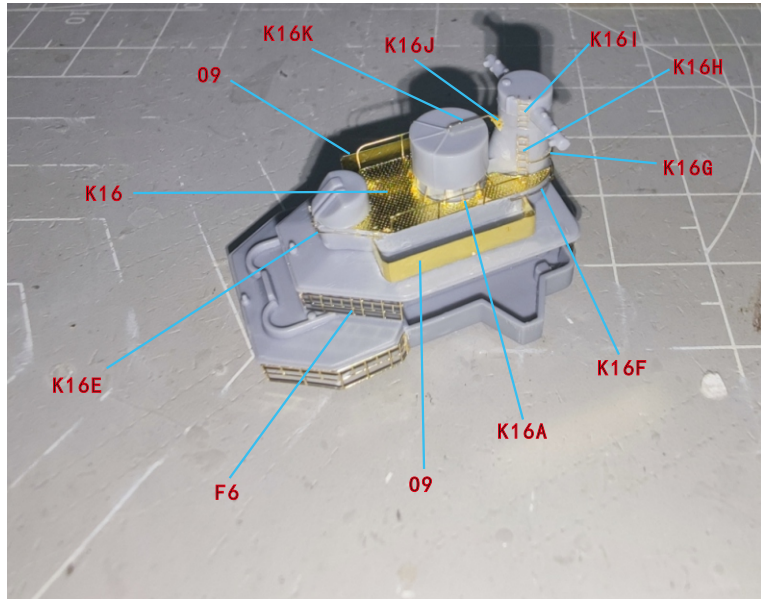
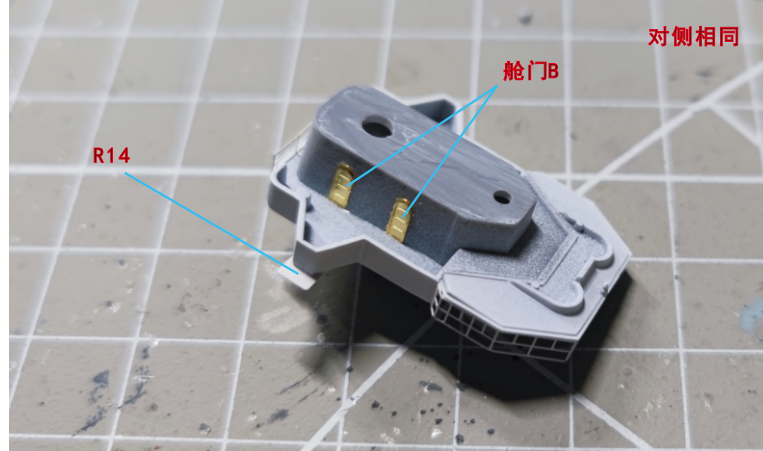
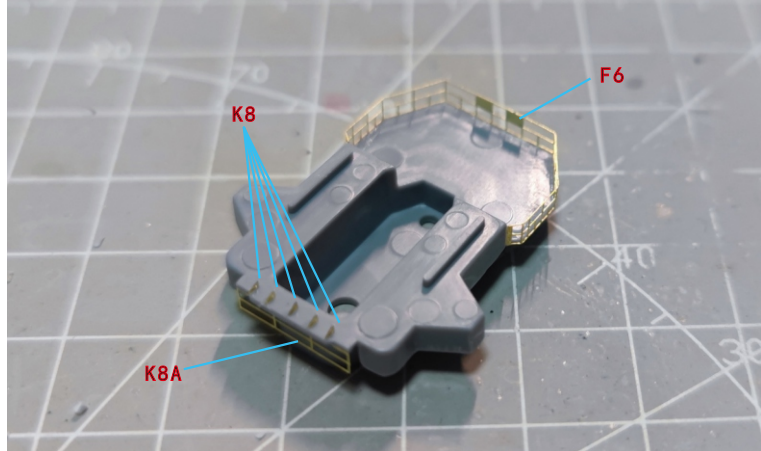
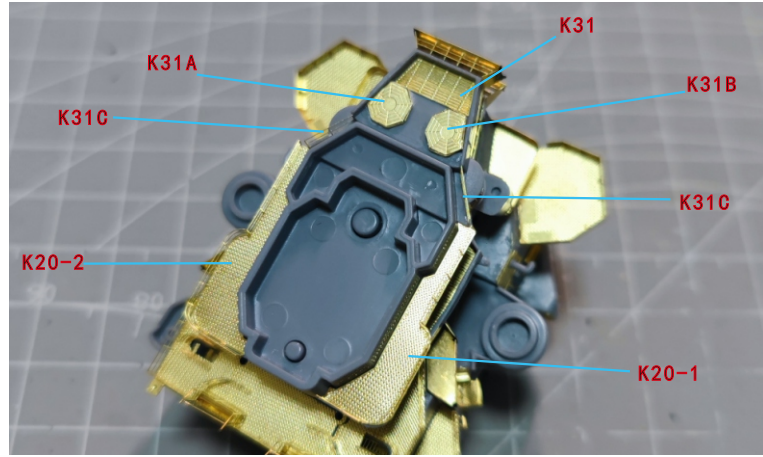
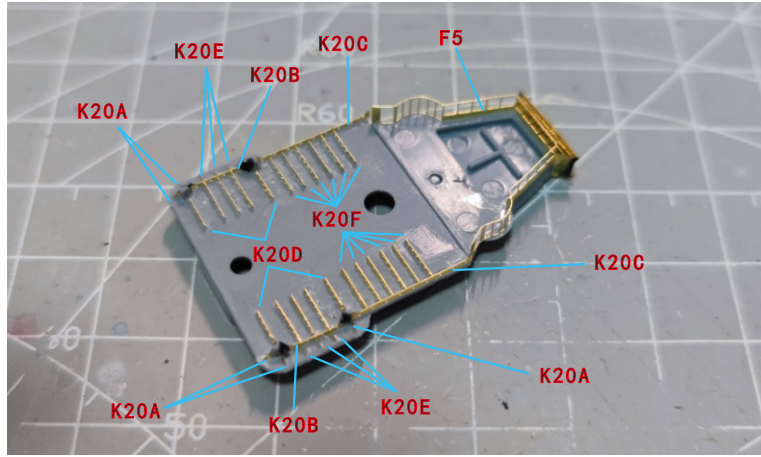
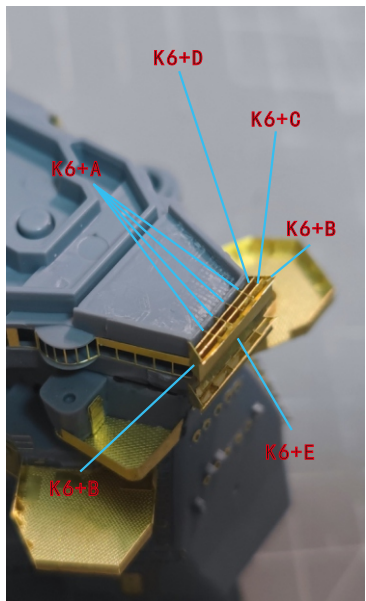
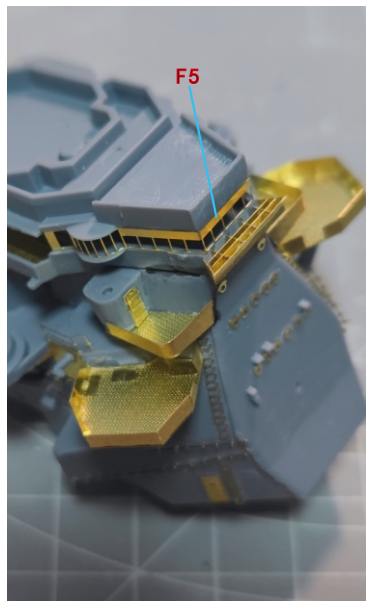
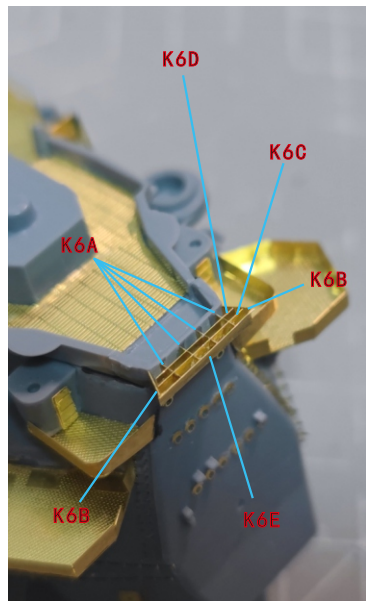
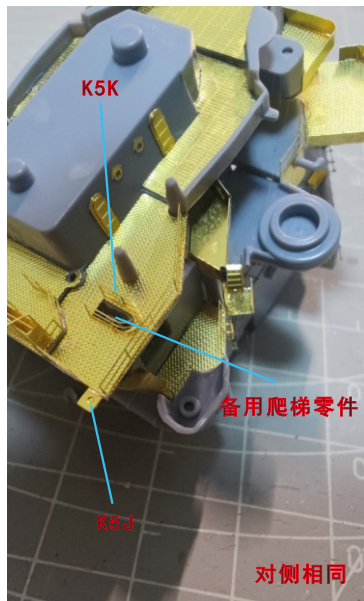

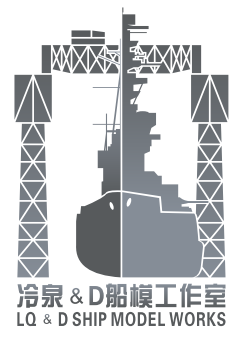
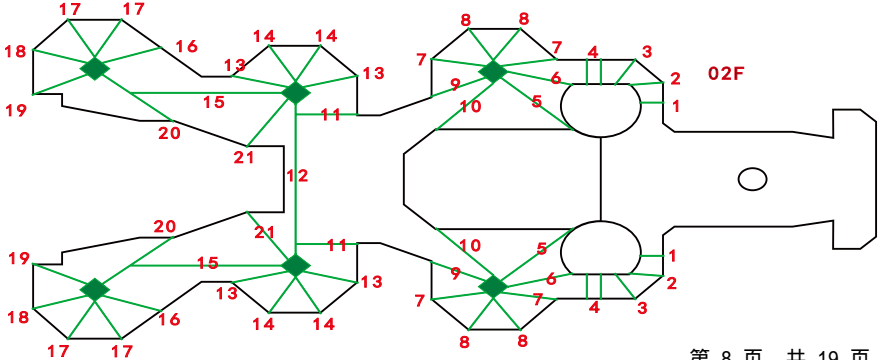
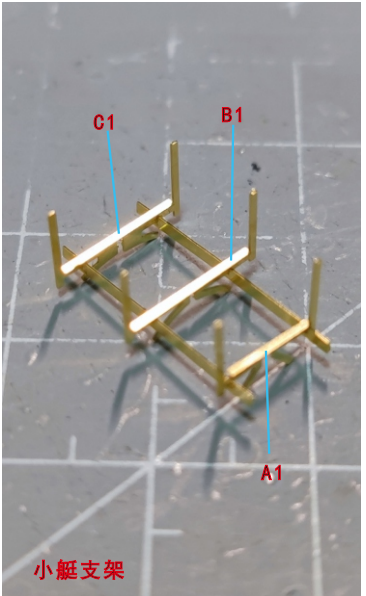
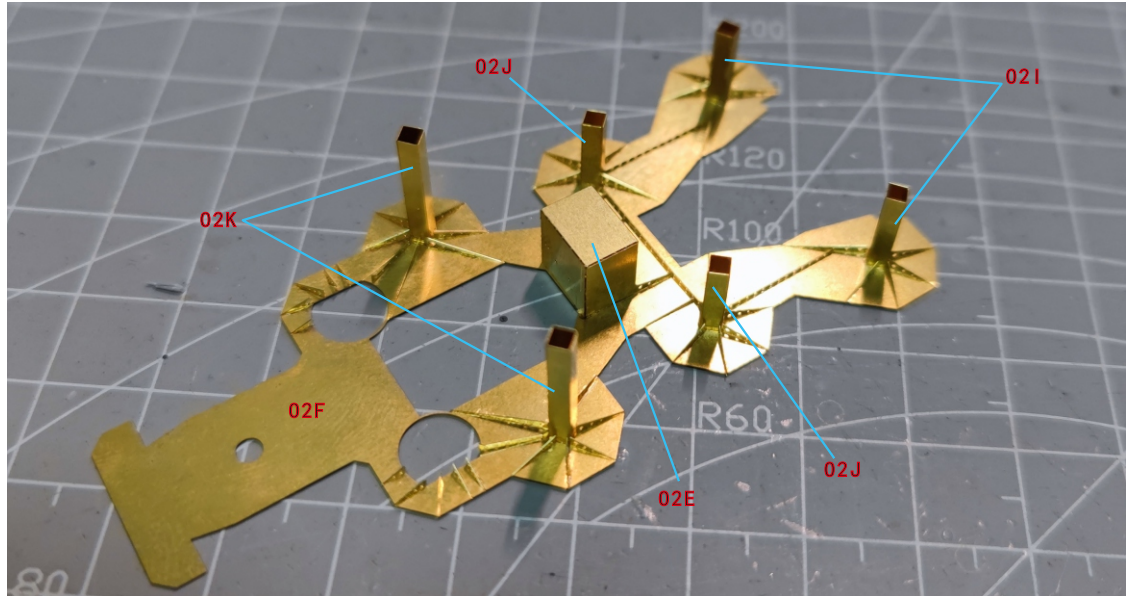
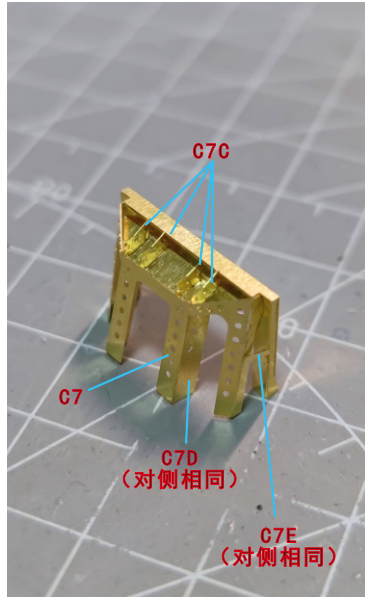
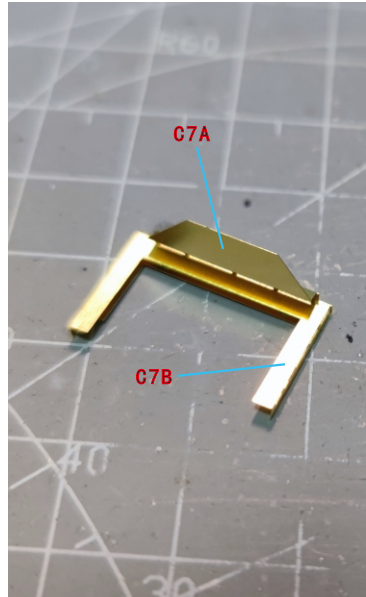
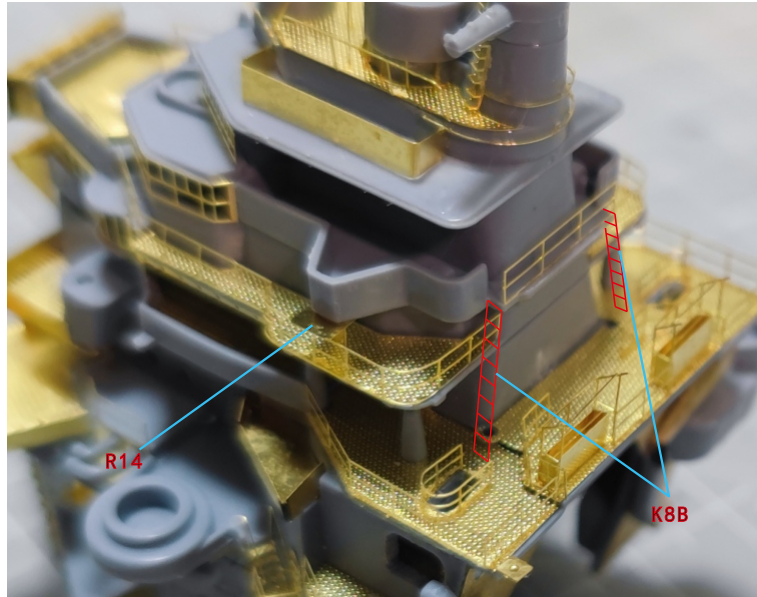
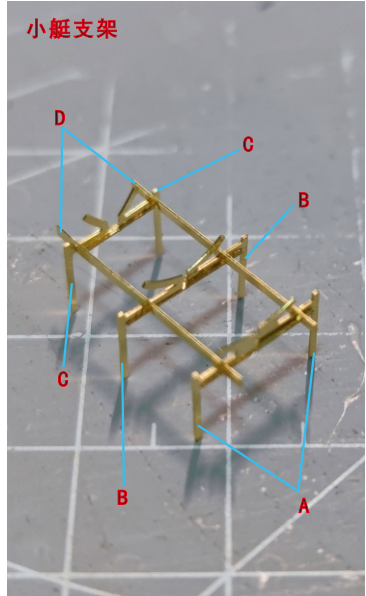
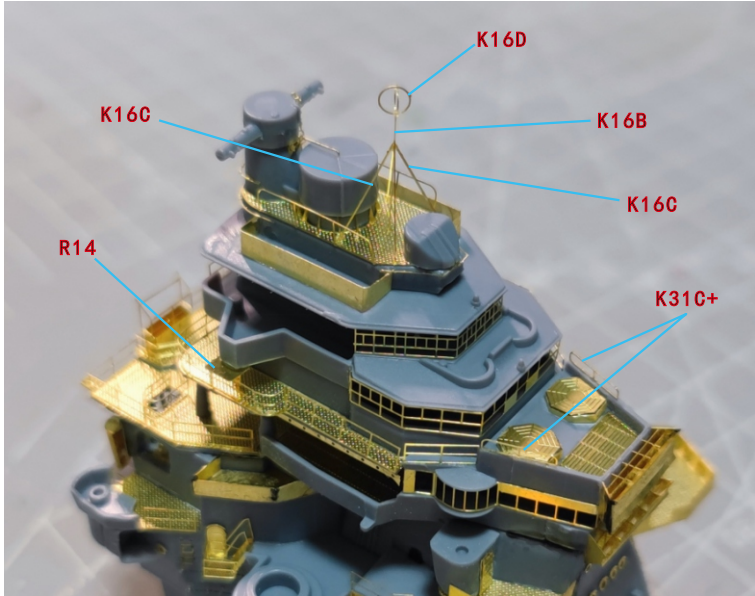
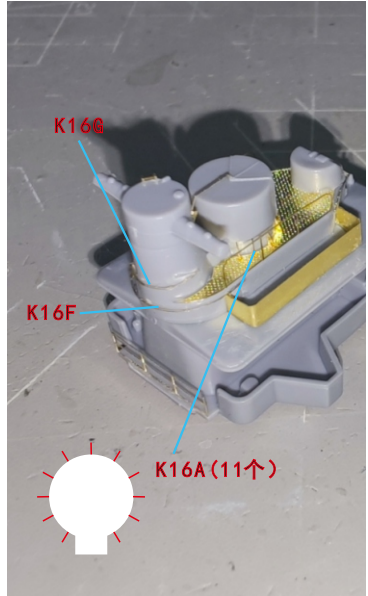

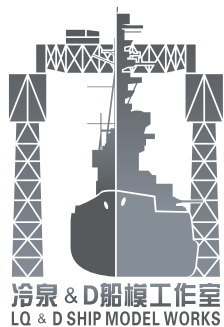
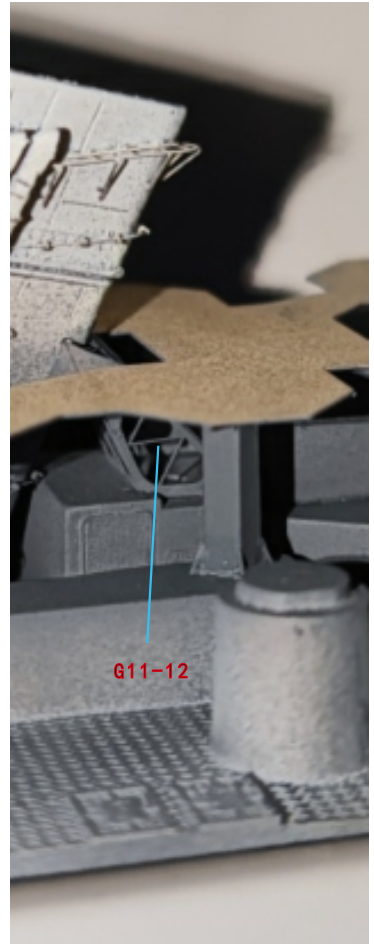
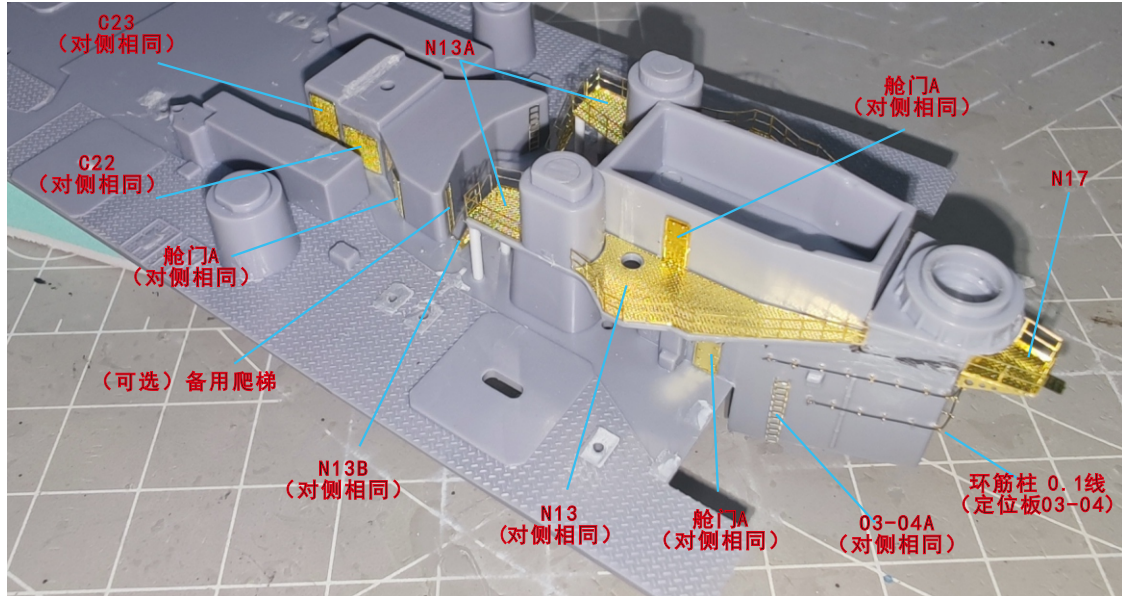
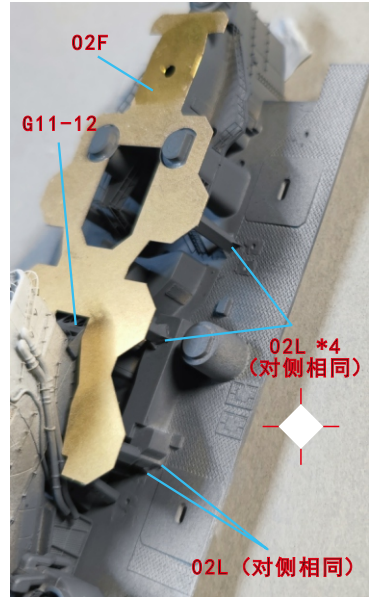
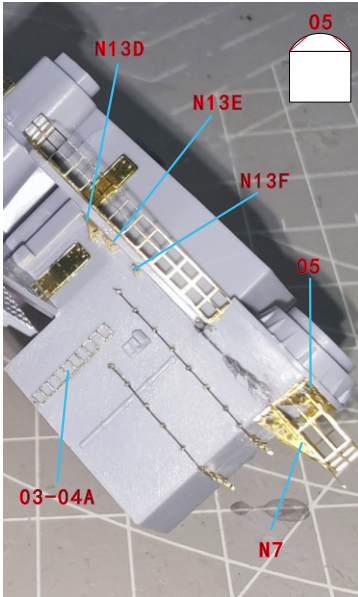
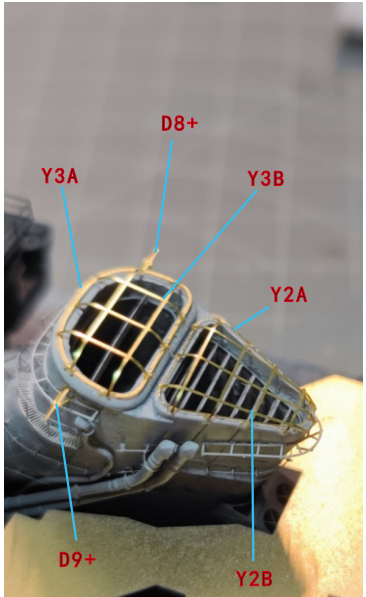
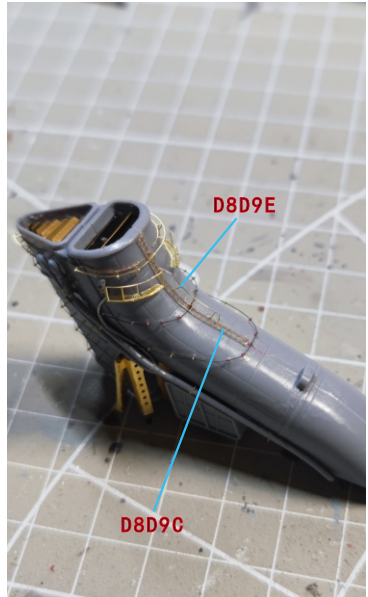

对侧相同

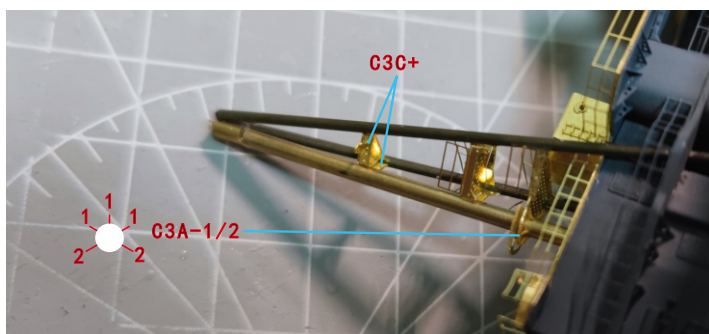
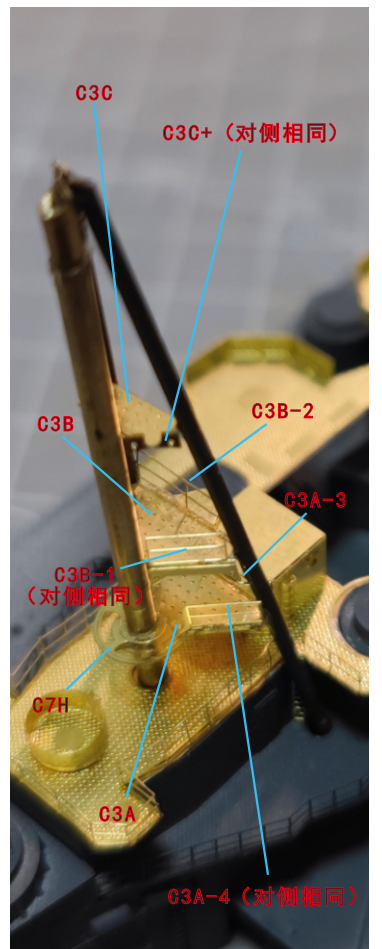
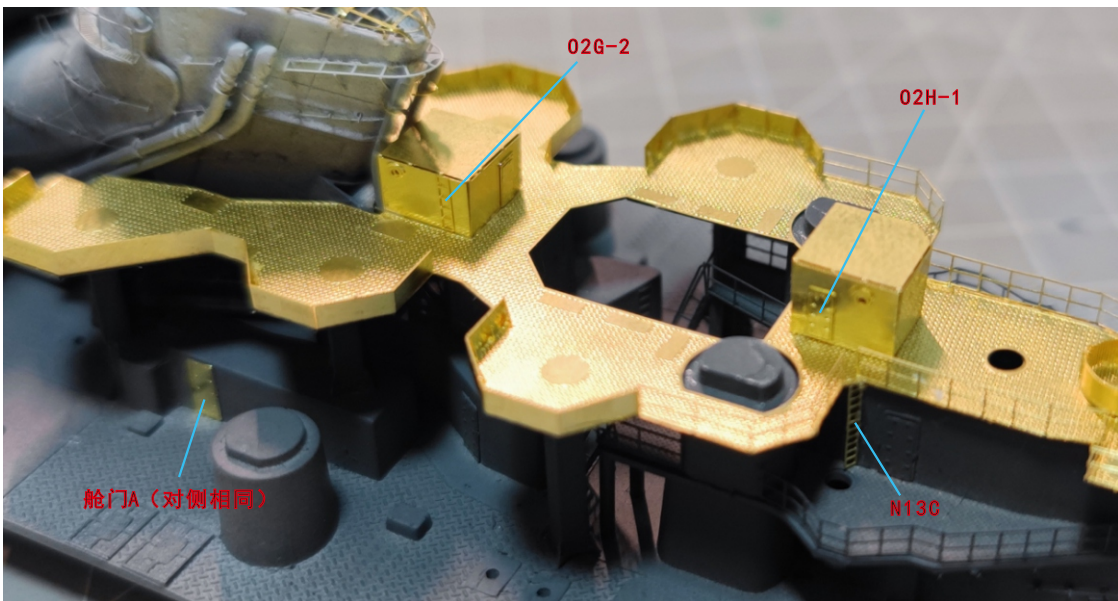
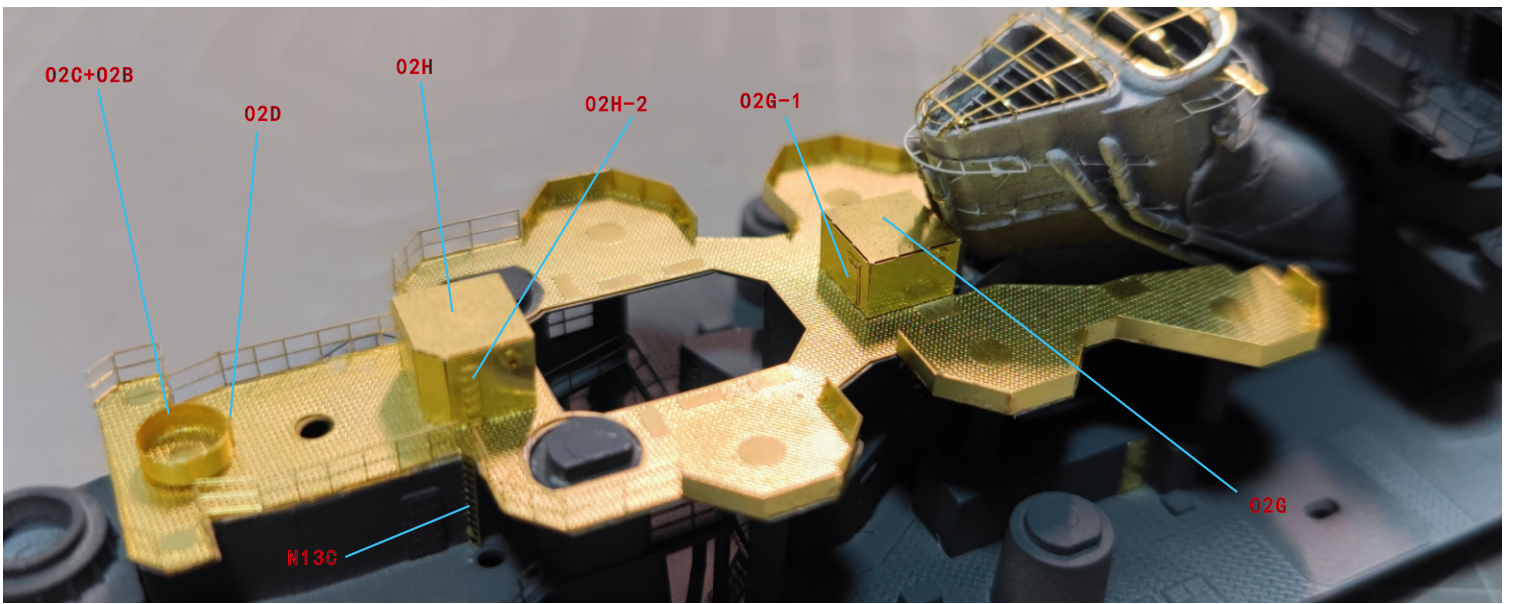
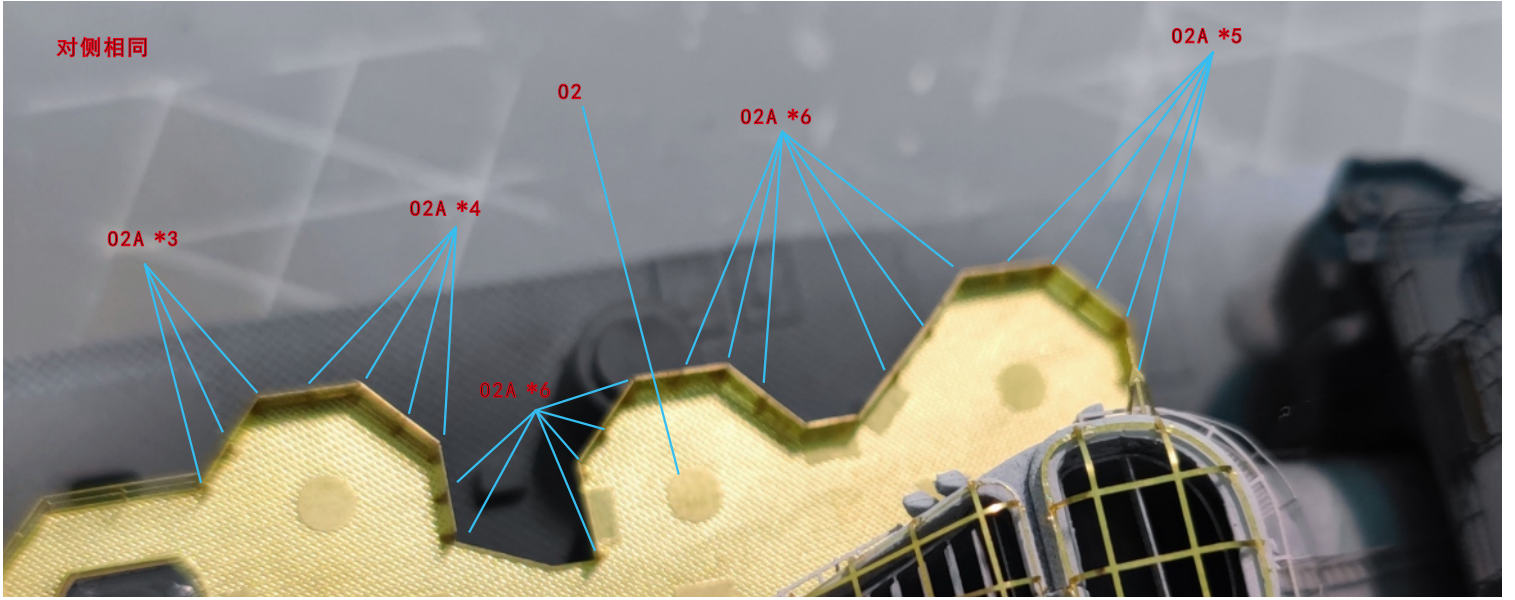

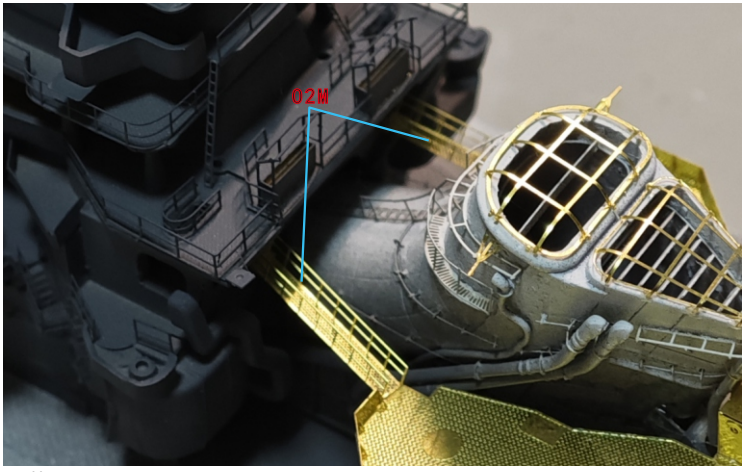
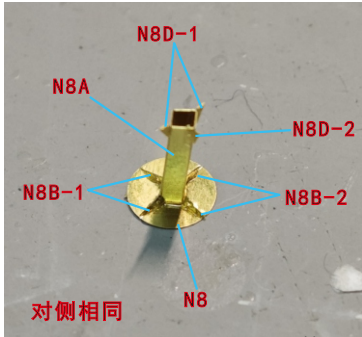
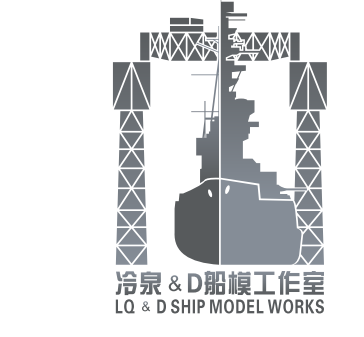
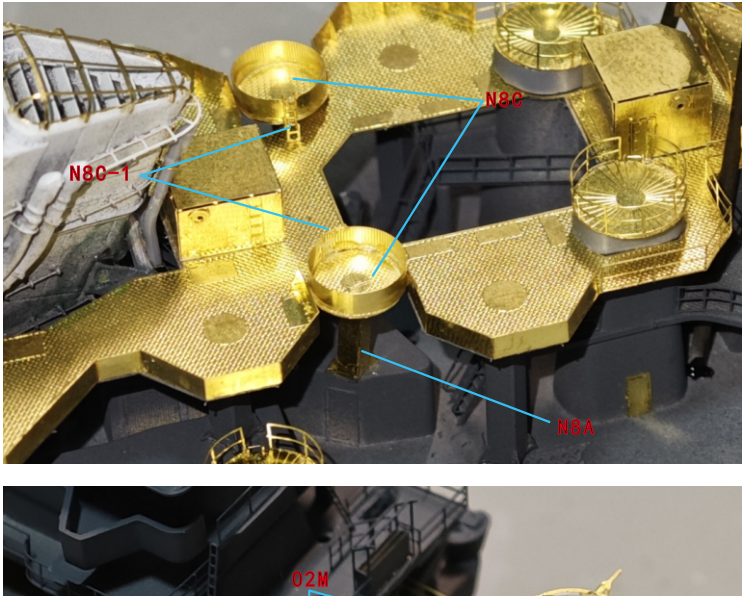
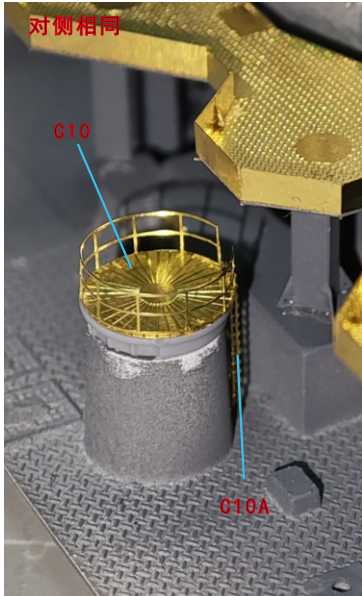
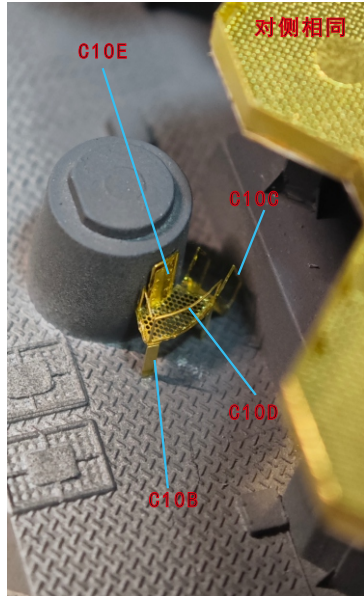
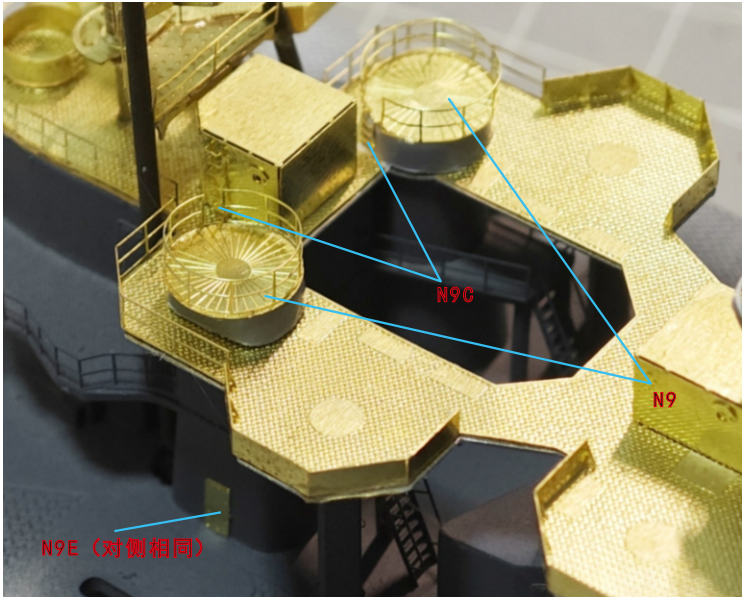
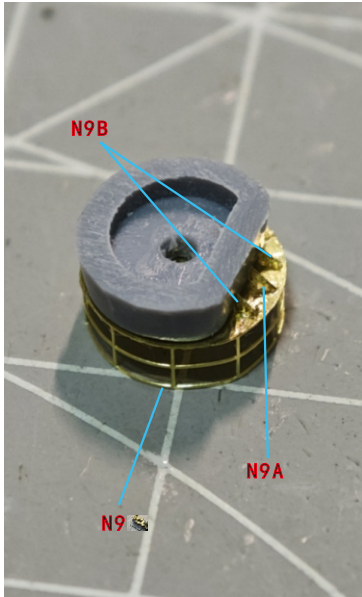
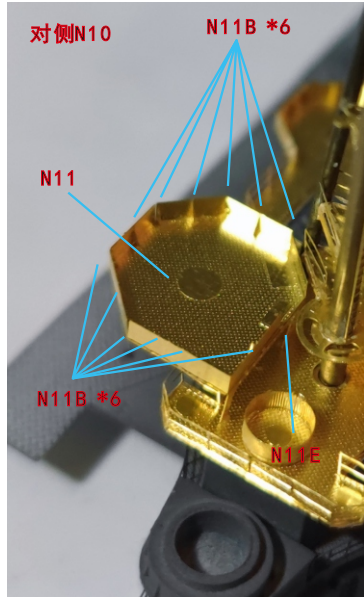
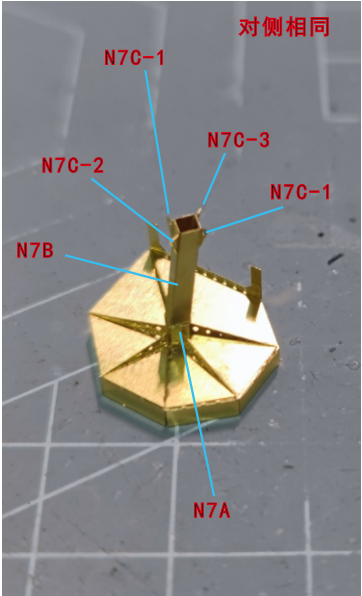
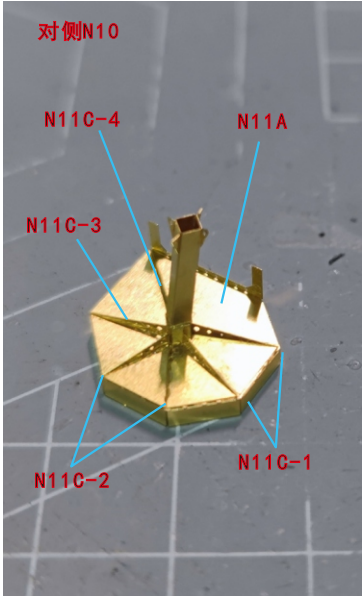
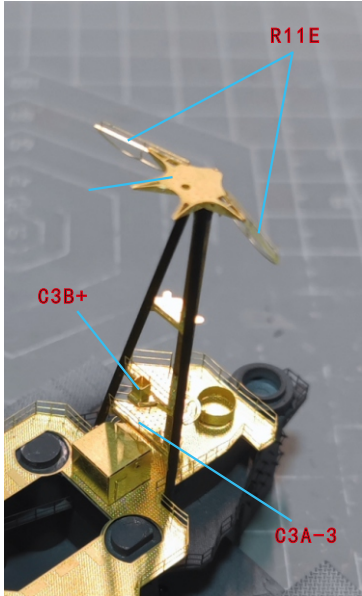
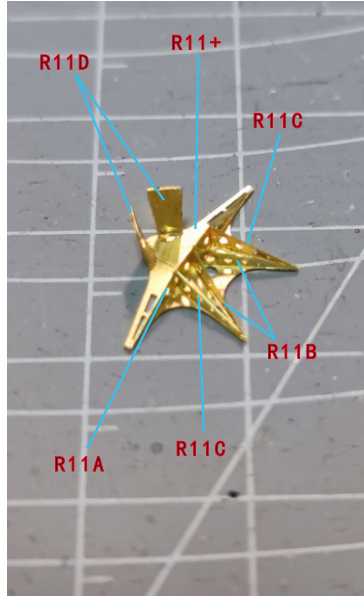

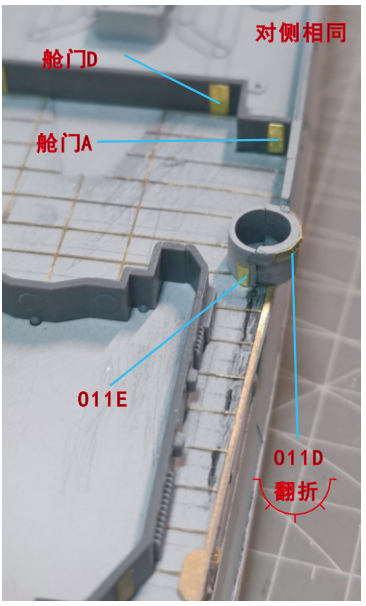
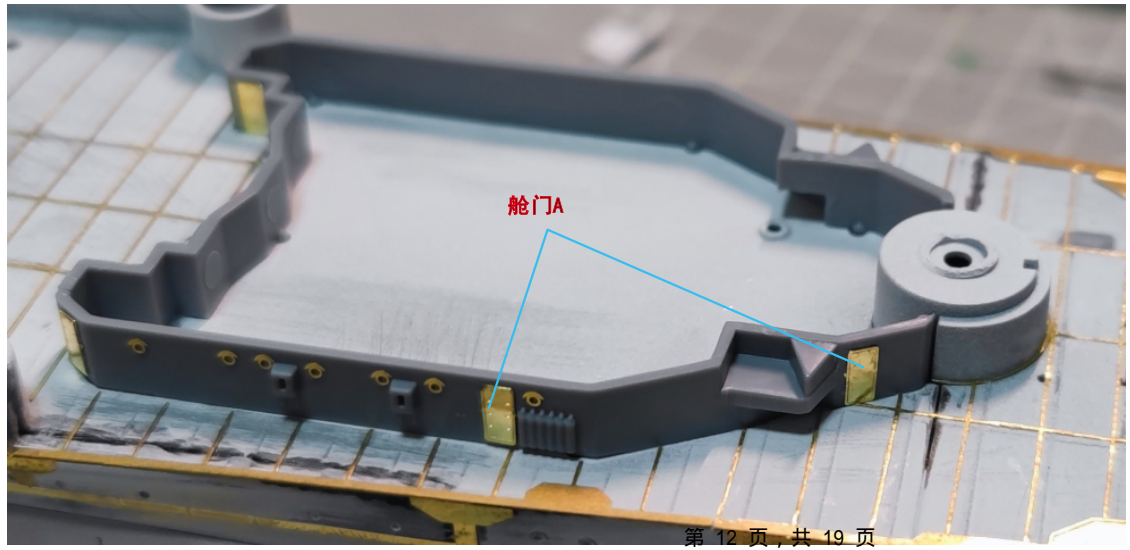
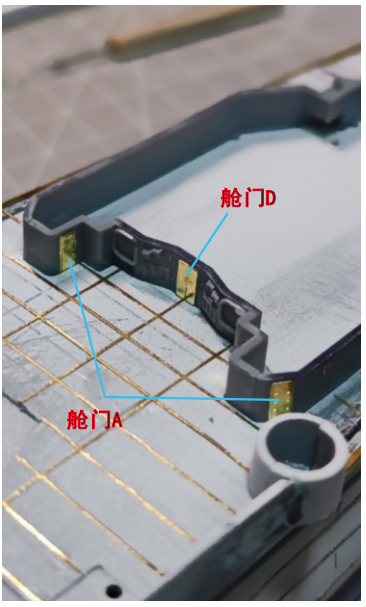
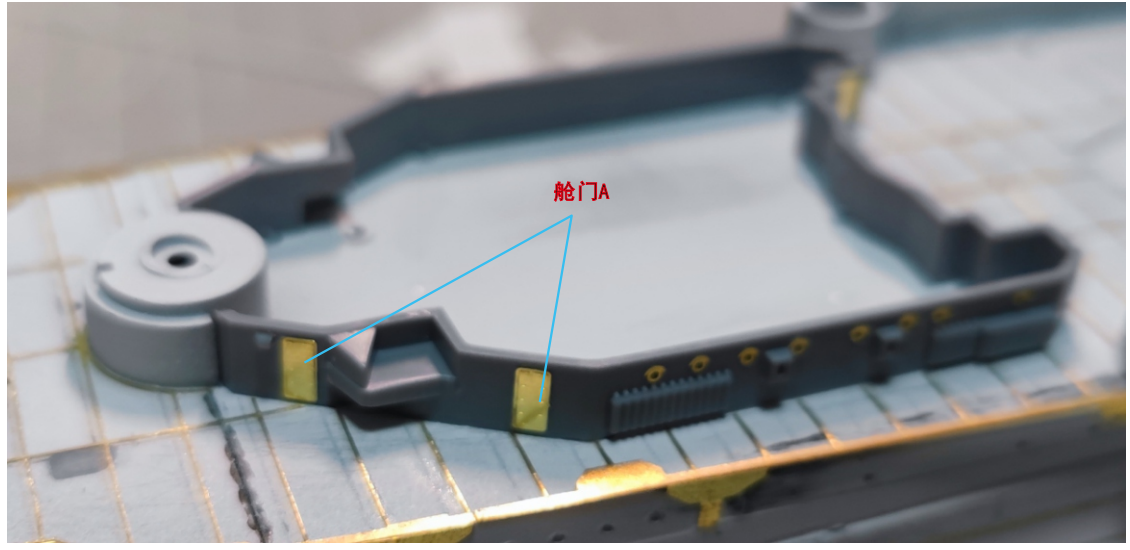
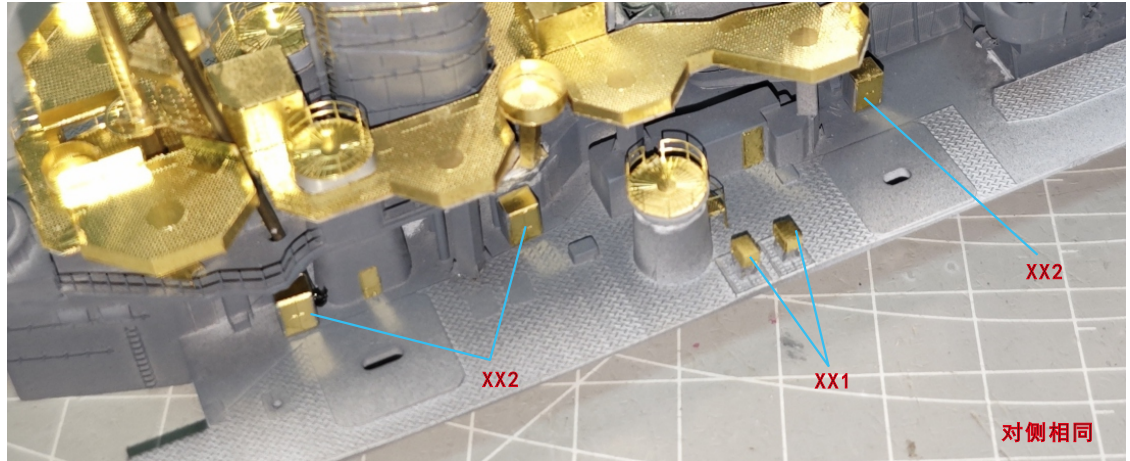
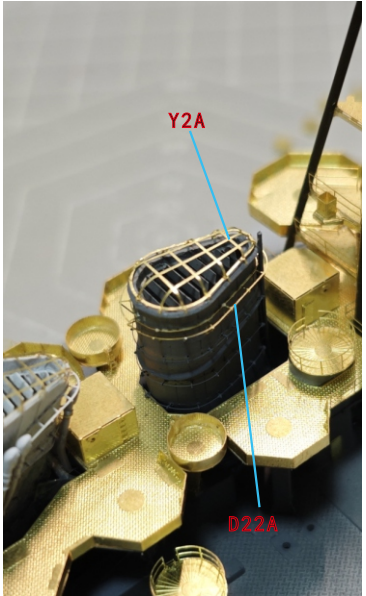
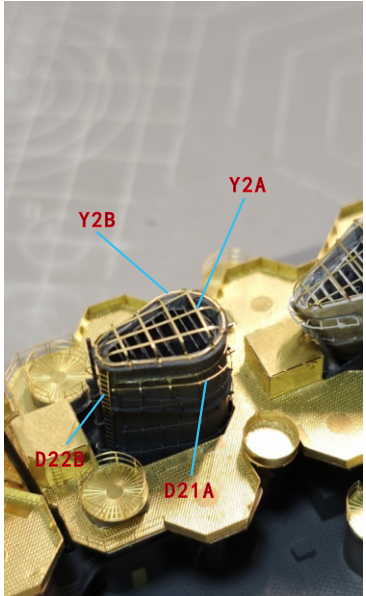
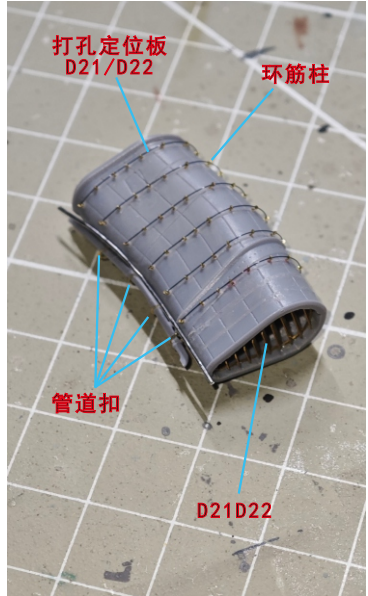

初回特典

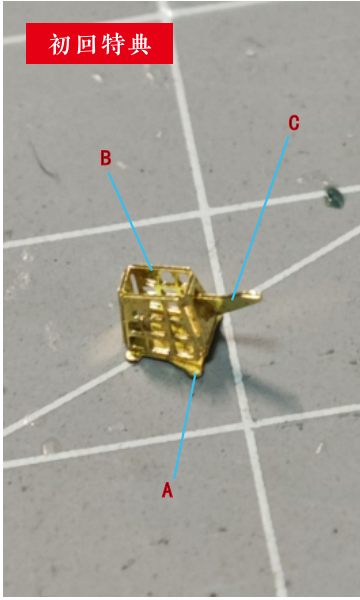

初回特典

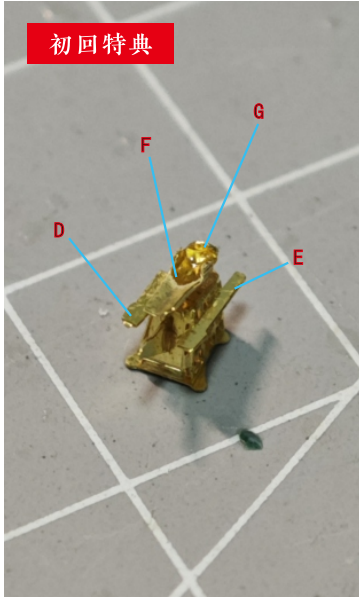

初回特典



初回特典

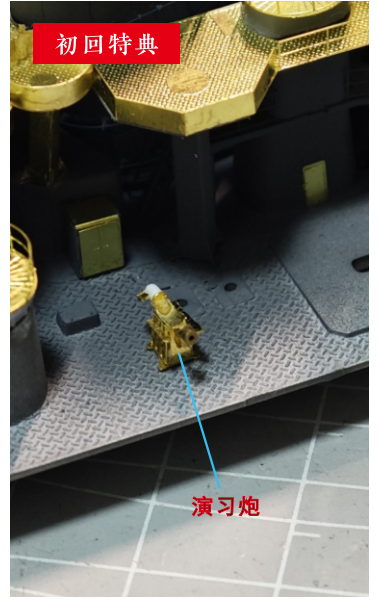

环筋柱 (间隔2MM, 对侧相同)

