

# 1/72 J.G.S.D.F TYPE 10 MBT Detail up set

722443

## for FUJIMI

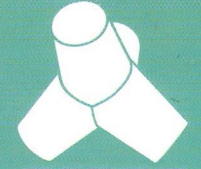

TETRA Model Works

www.tetramodel.com



반대쪽도 조립합니다.  
repeat on the opposite side  
向こうも同じ方法でつくり直します  
対面用一样的方法也重新做



2번 조립합니다.  
Make 2 sets.  
2組つくってくださいを  
同様制作二組



잘라냅니다.  
Remove / Cut  
切り取っています  
切去



구멍을 만듭니다.  
Make hole.  
穴あけてください  
鑽孔



누릅니다.  
Press  
押してください  
請按



선택 부품입니다.  
Optimal parts  
どちらかを選んでください  
可以選擇採用

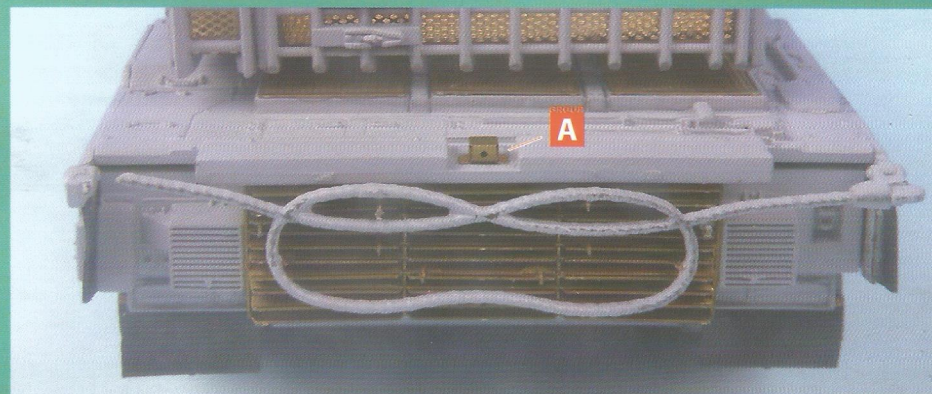
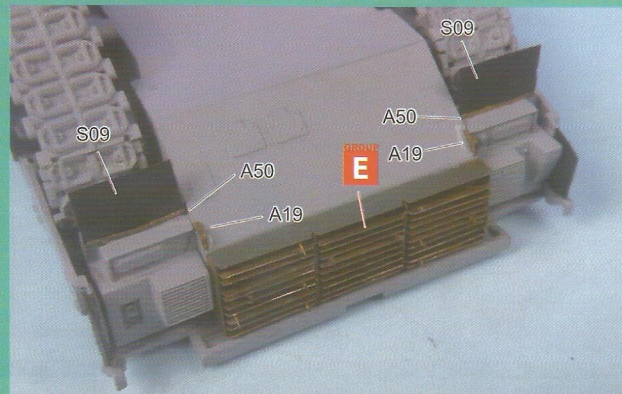
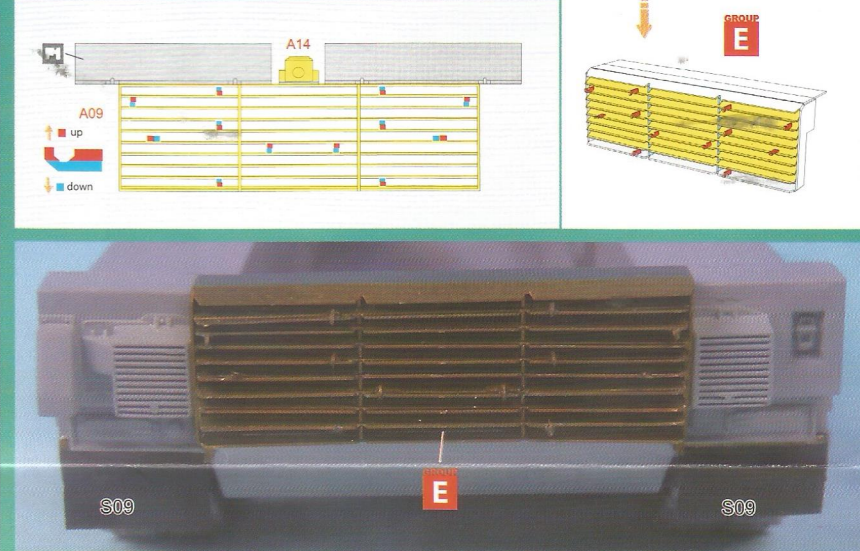
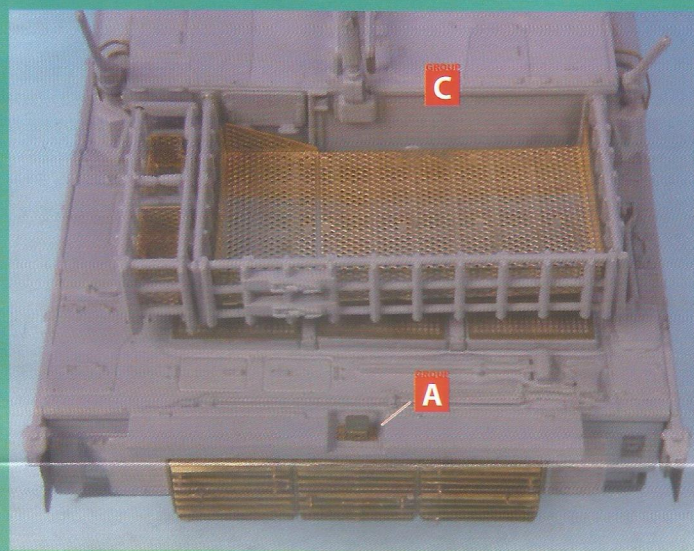
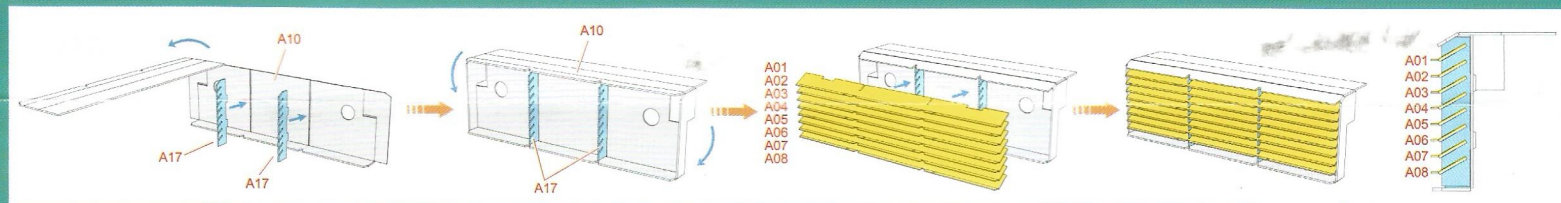
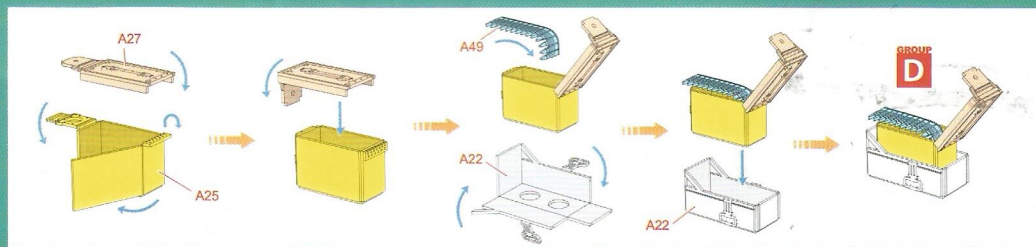
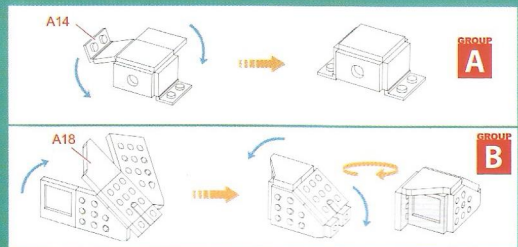
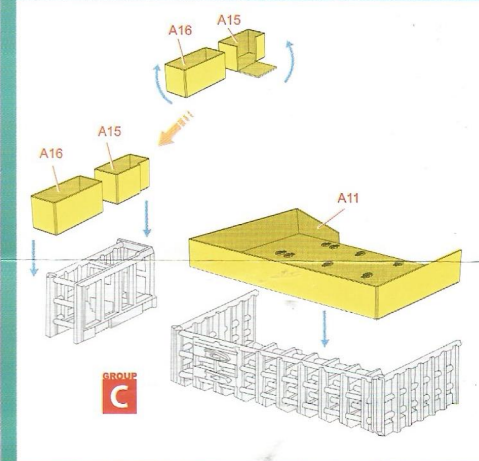
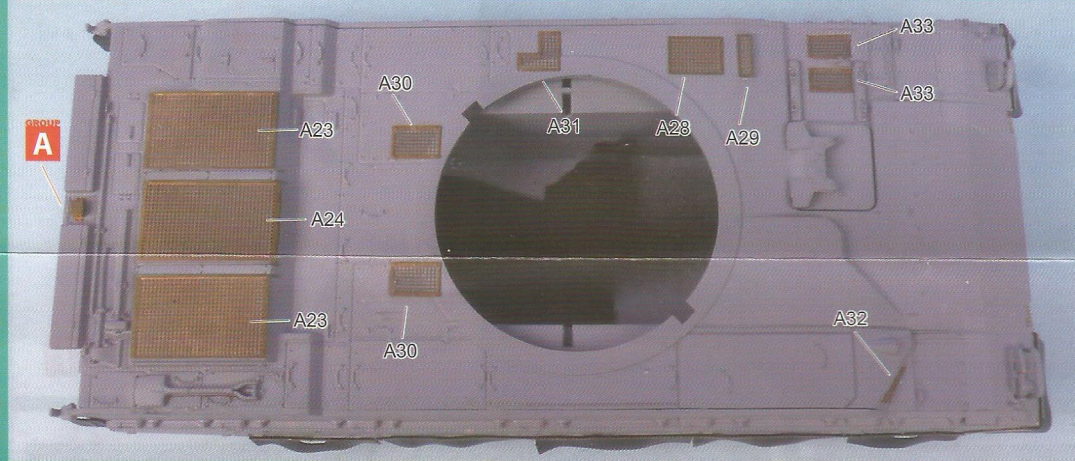
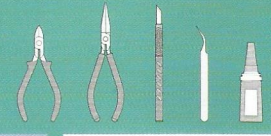



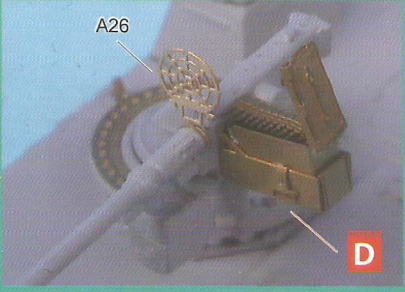
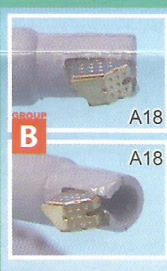
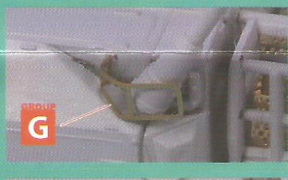
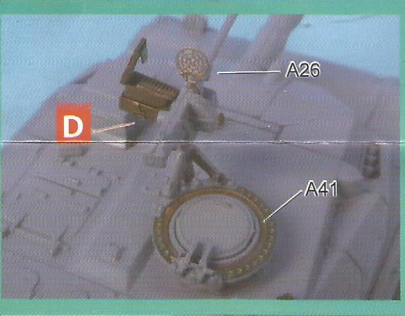
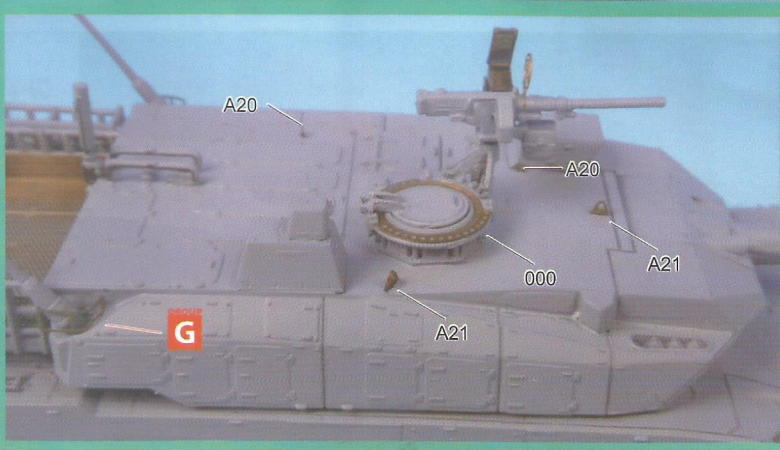
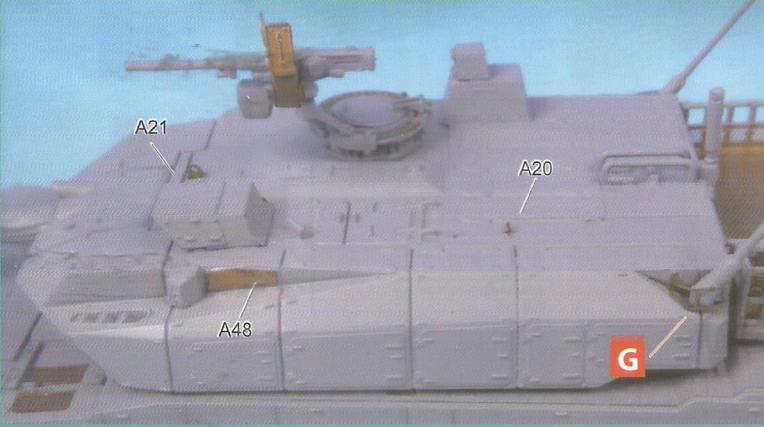
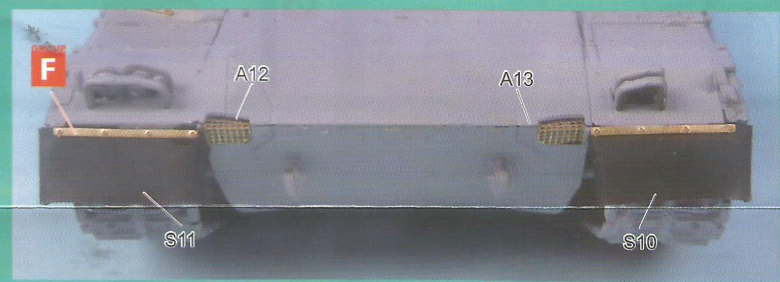
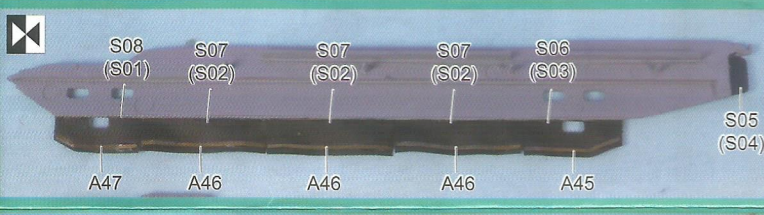
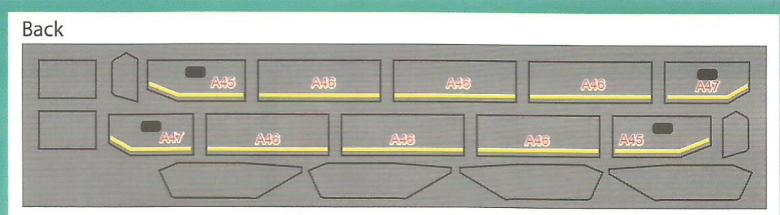
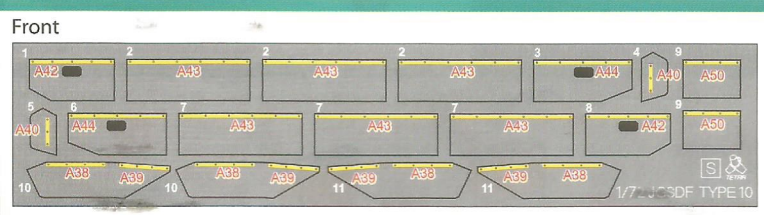
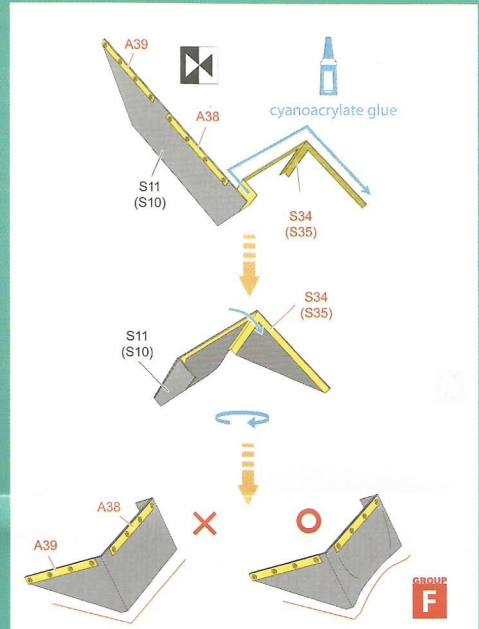
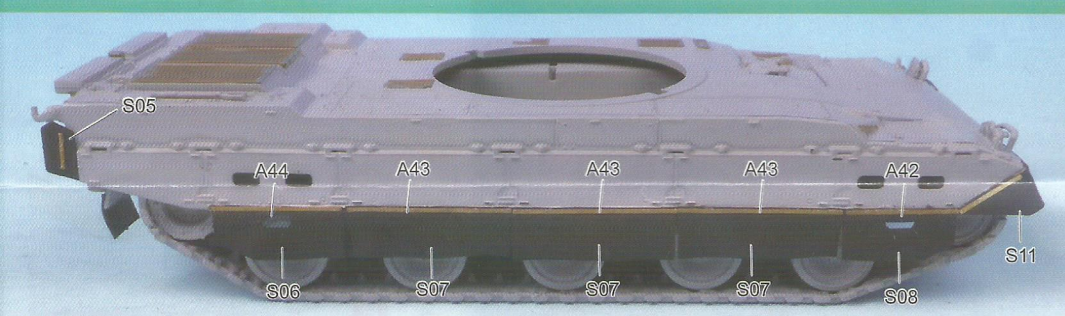
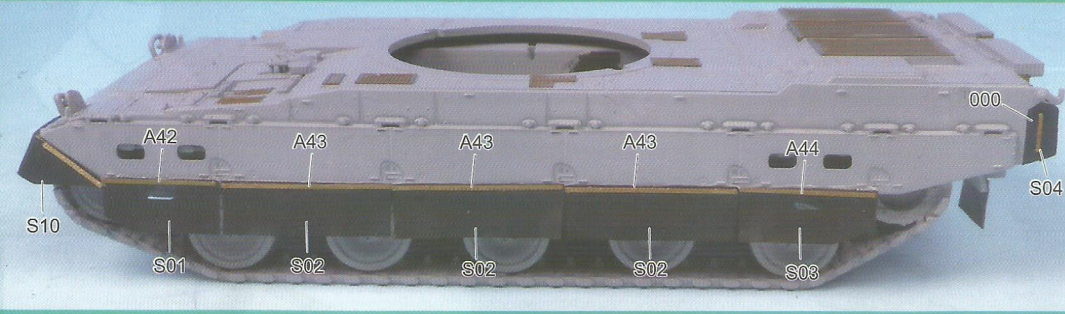

<http://www.facebook.com/tetramodel>

