

L7201
1/72 SCALE

G.W.H.[®]



U.S. AIRFORCE F-15E

IN ACTION OF OEF&OIF 美国空军F-15E“攻击鹰”战斗机

USAF addressed a requirement of a new long-range strikefighter to replace the General-Dynamic F-111 series fighter-bombers in march, 1981. McDonnell Douglas take a design based on F-15 twin-seater, which equipped with a pair of conformal fuel tanks (CFT) to get a longer combat range, and have a newly designed structure. McAir's new fighter named F-15E. At the same time, General Dynamic put out the F-16XL for competition, which prolong the fuselage of the basic F-16 and use big arrow wings instead of the original main wings and horizontal tails. Both new fighters can make long range attack which USAF expected. In the year 1985, Israel Air Force use

modified F-15Ds (Add CFTs and necessary avionics) take heavy guided-bombs made a very long range raid to the PLO headquarter in Tunisia, this successful attack provided a huge help to McAir's F-15E for the eventually victory. F-15Es continued the production of F-15s, after the air dominance Eagles off production. F-15E's derivative models were exported to many international users, such as Saudi Arabia's F-15S/SA, Israel's F-15I, Korean's F-15K and Singapore's F-15SG, etc. Nowadays, when USAF conduct air-to-ground attacks, F-15Es would arrive the battlefield. In the foreseeable future, Strike Eagles will remain to be the main power of the tactical strike in USAF.

1981年3月，美国空军提出了F-111战斗轰炸机后继机型的需求，麦道公司在F-15双座型飞机的基础上，加装了保形油箱，并对机体结构进行了脱胎换骨的改进，提出了F-15E“双重任务战斗机”方案，而通用动力公司则拿出了加长机体，改用箭形机翼无尾布局的F-16XL方案，二者皆可满足美国空军提出的远程打击的作战要求，在1985年，以色列用经过简单改装，加装保形油箱的F-15D双座战斗机，挂载重型制导炸弹，对远在突尼斯的巴解总部成功进行了令人难以置信的远程奔袭，这个战例无疑为麦道公司的方案送

上了“神助攻”，使该公司基于现有成熟机体研发的F-15E最终战胜对手，成功入选。在F-15C/D制空型战斗机停产后，接续了F-15系列战斗机的生产。后来，基于F-15E的各种改型出口到多个国家，例如出口沙特阿拉伯的F-15S/SA，出口以色列的F-15I，出口韩国的F-15K，出口新加坡的F-15SG等。现在，只要有美国空军参与对地打击的作战行动，就有F-15E的身影出现，在可见的将来，“攻击鹰”仍然是美国空军战术打击力量的绝对主力。



L7201 U.S. AIRFORCE F-15E in Action of OEF&OIF

零件表 PARTS LIST パーツリスト

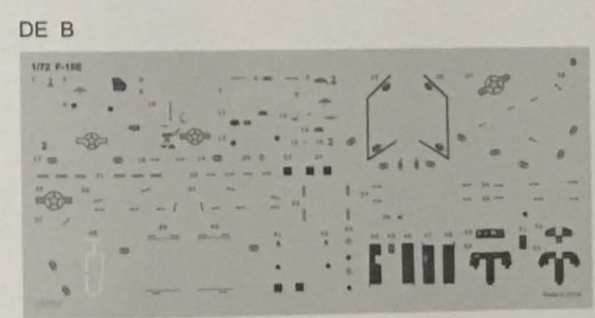
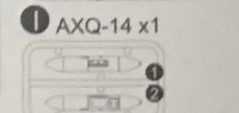
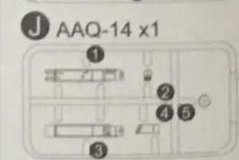
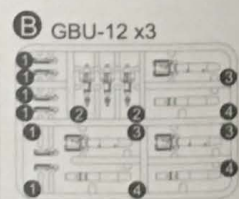
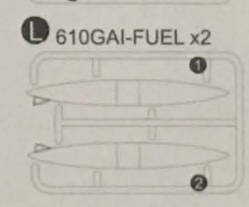
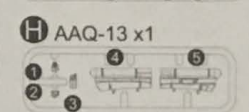
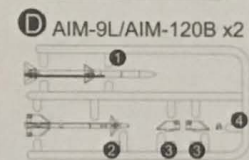
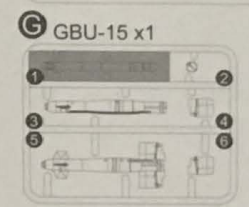
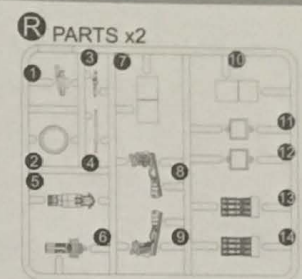
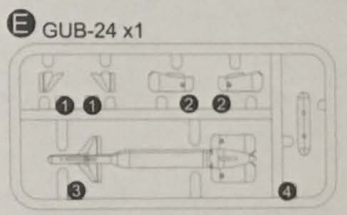
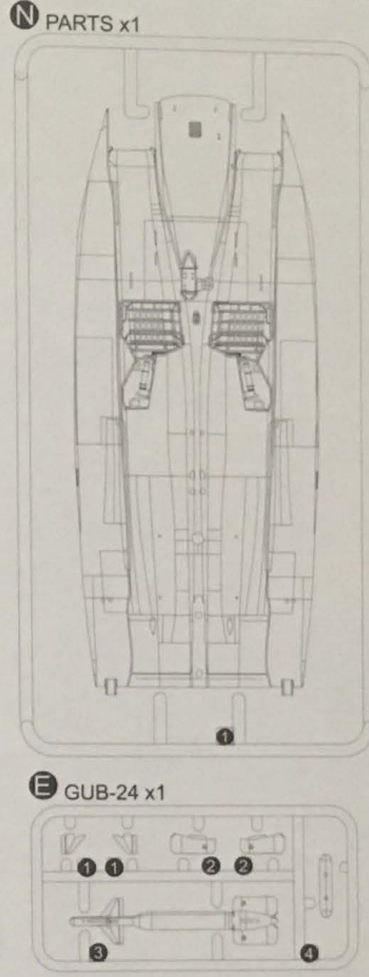
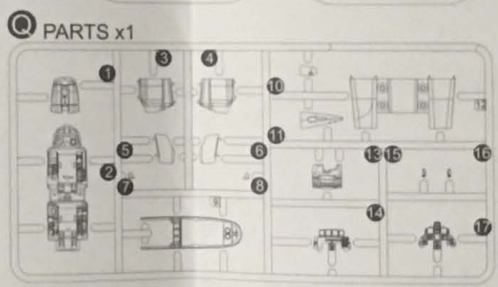
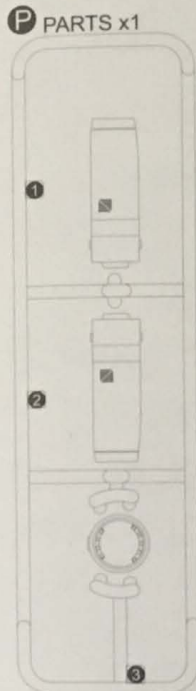
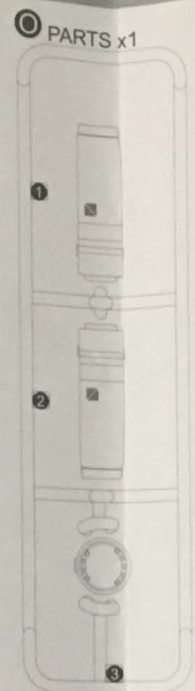
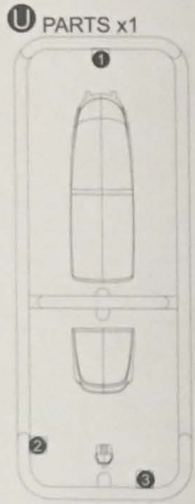
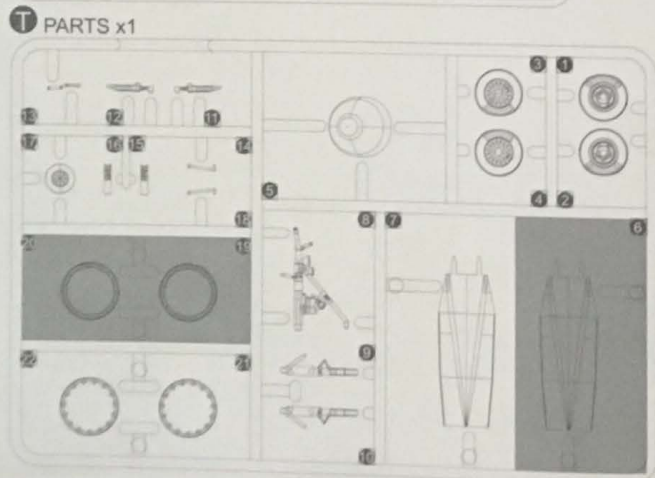
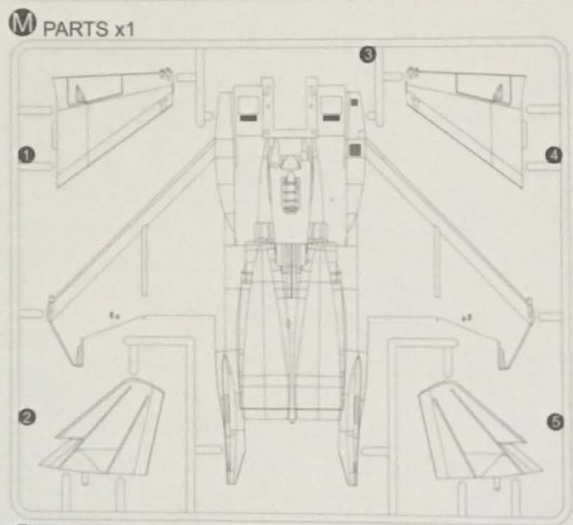
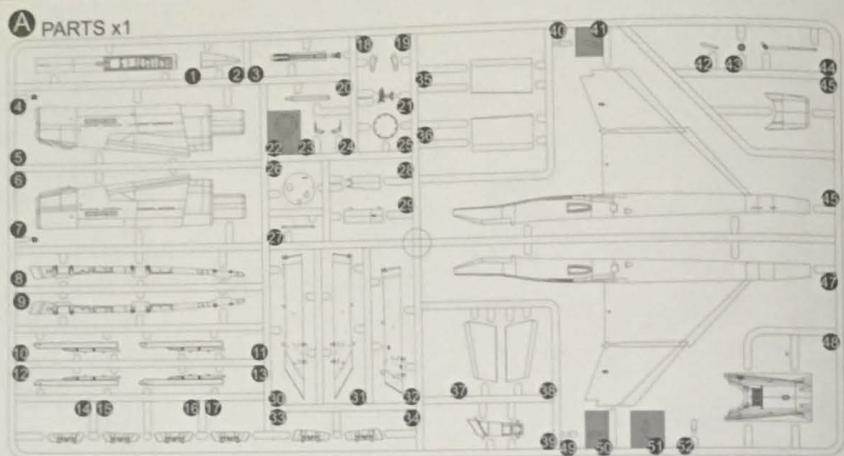

Parts not for use
不需要板件零件

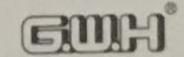













注意事項 CAUTION 組み立てのご注意

- (1) 勿于近火处使用胶水或油漆, 并打开窗户保持空气流通。
- (2) 涂料的号码请参考本栏以下的说明。本品本身不包括胶水和涂料。
- (3) 自板件中取出部件时, 应用模型专用剪, 并用介刀或小锉除去多余胶料。
- (4) 各图形的含义可参考本栏以下说明。

- (1) When you use glue or paint, do not use near a open flame, and use in a well-ventilated room.
- (2) See below for the color list. Glue and paint are not included in the kit.
- (3) When you take parts off the runner frame, use the modeling scissors and trim excess plastic with a cutter or a file.
- (4) See below for the meaning of symbols.

- (1) 接着剤や塗料は火の近くで使わないで下さい。使用の際は換気をよくして下さい。
- (2) 塗料指定のは下記のとおりです。接着剤や塗料は入っていませんので別に求めて下さい。
- (3) 部品のランナーから切り離す時は模型用ハサミ等を使い、余分な部分はカッターやヤスリ等で仕上げて下さい。
- (4) 組立図のサインマークは下の説明を御覧下さい。

图形含义 CAUTION マーク

 填平 FILL HOLE 穴を埋めて下さい	 水印贴纸 APPLY DECAL デカールを貼って下さい	 切除 CUT OFF 切り取って下さい	 配重块 COUNTER WEIGHT 重り	 制作两组 MAKE TWO SET 2個作って下さい	 另一側相同制作 DO THE SAME ON THE OPPOSITE 反対側も取り付けます
 胶水 CEMENT 接着して下さい	 钻孔 OPEN HOLE 穴を開けて下さい	 选择使用 OPTIONAL どちらを選んで下さい	 不用胶水 NO CEMENT 接着しないで下さい	 注意 BE CAREFUL 注意して下さい	 瞬間胶 INSTANT GLUE FOR METAL 瞬間接着剤 (金属用)

所使用工具 RECOMMENDED TOOLS 専用工具

 塑胶件用模型胶水 Cement プラスチック用接着剤	 模型用剪钳 Side cutters 模型用ニッパー	 模型用镊子 Tweezers ピンセット
 模型用瞬間胶水 Instant Cement 瞬間接着剤	 模型用刻刀 Modeling knife 模型用ナイフ	 模型用锉刀 Diamond file 模型用ヤスリ

水贴纸使用说明 DECAL APPLICATION スライドマークの貼り方

- (1) 用模型剪刀或刻刀切下所需的图案部分。
- (2) 将水贴纸浸泡在温水中10秒左右取出放置于戏水的干布上。
- (3) 手拿着水贴纸基的一角, 用模型镊子小心夹住浮起的水贴图案移至模型表面准确位置。
- (4) 用手指适当沾水均匀涂于水贴图案表面, 使其延展移动至精确位置。
- (5) 用柔软吸水的干布将水贴图案中的气泡向一边挤出, 使水贴在模型表面保持平整。

- (1) Cut off decal from sheet.
- (2) Dip the decal in tepid water for about 10 sec. and place on a clean cloth.
- (3) Hold the backing sheet edge and slide decal onto the model.
- (4) Move decal into position by wetting decal with finger.
- (5) Press decal down gently with a soft cloth until excess water and air bubbles are gone.

- (1) 貼りたいマークをハサミで切り抜きます。
- (2) マークをぬるま湯に10秒ほど浸してからタオル等の布の上に置きます。
- (3) 台紙のはしを手で持ち、貼るところにマークをスライドさせてモデルに移して下さい。
- (4) 指に少し水を付けてマークを濡らしながら、正しい位置にずらしします。
- (5) 柔らかい布でマークの内側の気泡を押し出しながら、押しつけるようにして水分をとります。

蚀刻片使用说明 PHOTO-ETCHED PARTS エッチングパーツ

- (1) 使用蚀刻片专用剪刀或模型专用刻刀将蚀刻片零件切割下待用。
 - (2) 切割下的零件上有蚀刻片的残留连接点部分, 使用模型专用锉刀细心打磨干净。
 - (3) 蚀刻片部分在涂装之前必须使用专用的模型金属底漆打底。
- 注意事项: 蚀刻片很薄外延较为尖锐, 有刮伤手的可能, 在使用之时请务必小心。

- (1) Cut off photo-etched parts using a modeling knife.
 - (2) Carefully remove any excess using a file.
 - (3) Apply metal primer prior to painting.
- Attention, please: Extra care should be taken to avoid personal injury when handling photo-etched parts.

- (1) 切り離す時はカッターナイフを使用してパーツを切り離します。
 - (2) 切り出した時、部品に出張った部品が残っている場合は、ヤスリなどで丁寧に削り落とします。
 - (3) 塗装が必要なパーツは下地にメタルプライマーを吹き付けてから塗装します。
- ご注意: エッチングパーツは大変薄く、手などを切り恐れがあります。取扱いには十分注意して下さい。

涂装色表 PAINT REQUIRED カラー番号リスト

■ C1000 GSI CREOS Mr.COLOR

■ A.MIG-000 米格色号

C3	—	—	红色	RED	C137	—	—	轮胎黑	TIRE BLACK
C6	—	—	光泽绿色	CLOSS GREEN	C305	MIG-204	FS36118	舰炮灰	GUNSHIP GRAY
C8	—	—	银色	SILVER	C308	—	—	浅幽灵灰	LIGHT GHOST GREY
C28	—	—	黑铁色	STEEL	C316	MIG-047	FS17875	光泽白	WHITE
C33	MIG-046	FS37038	消光黑	FLAT BLACK	C317	MIG-205	FS36231	暗海鸥灰	GRAY
C47	—	—	透明红	CLEAR RED	C318	—	—	雷达罩色	RADOME
C57	—	—	金属蓝色	Metalic Blue	MC213	—	—	不锈钢色	STAINLESS
C50	—	—	透明蓝	CLEAR BLUE	C307	—	FS36320	深幽灵灰	DARKGHOST GRAY

Ⓐ00 : 水贴A版编号

Ⓑ00 : 水贴B版编号

1

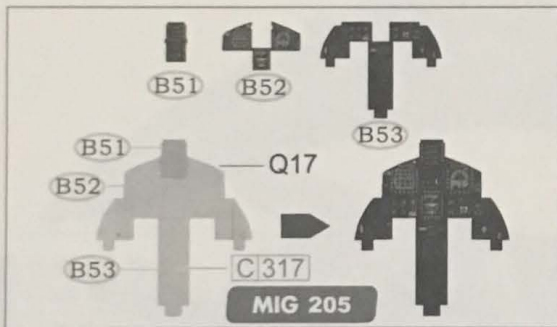
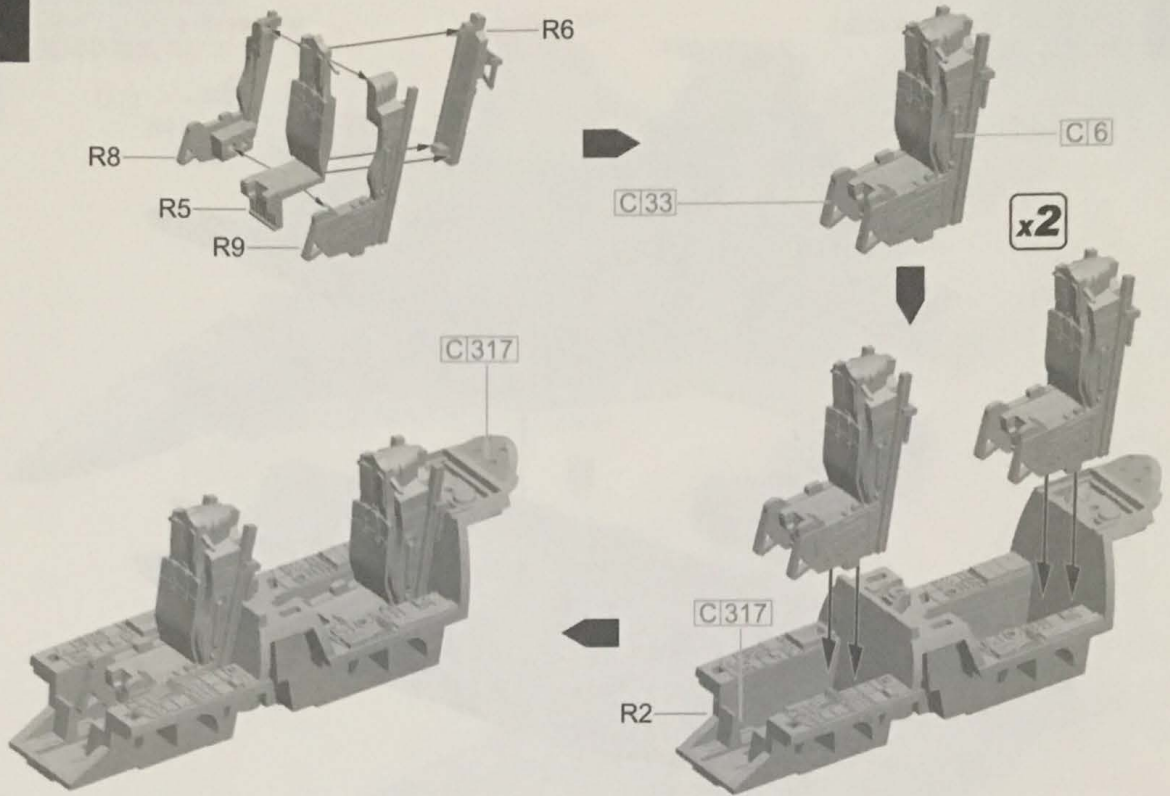

前仪表板
Front Instrument Panel
前にダッシュボード

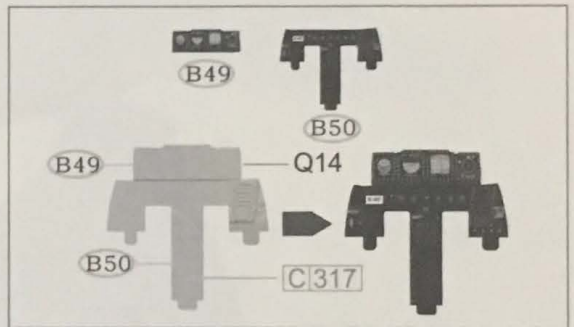

后仪表板
Rear Instrument Panel
後にダッシュボード

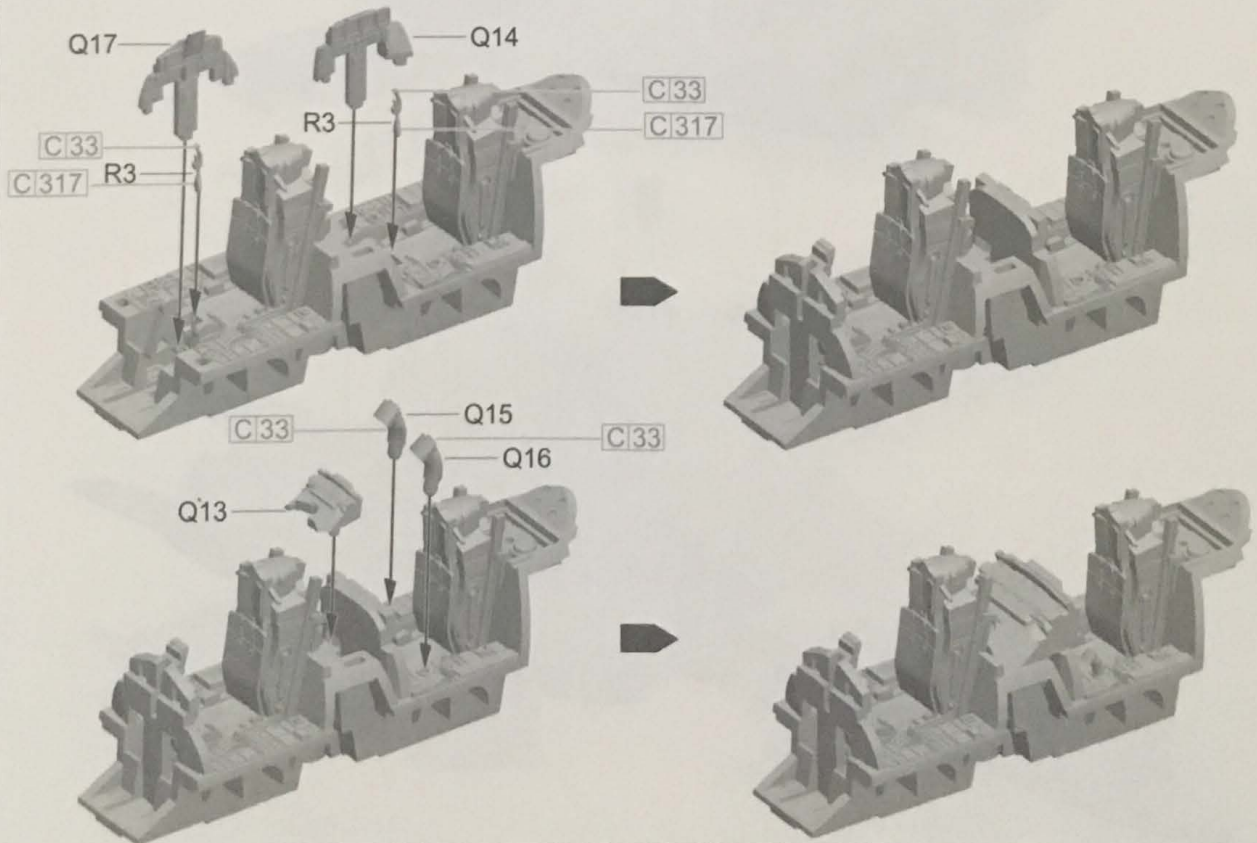

2

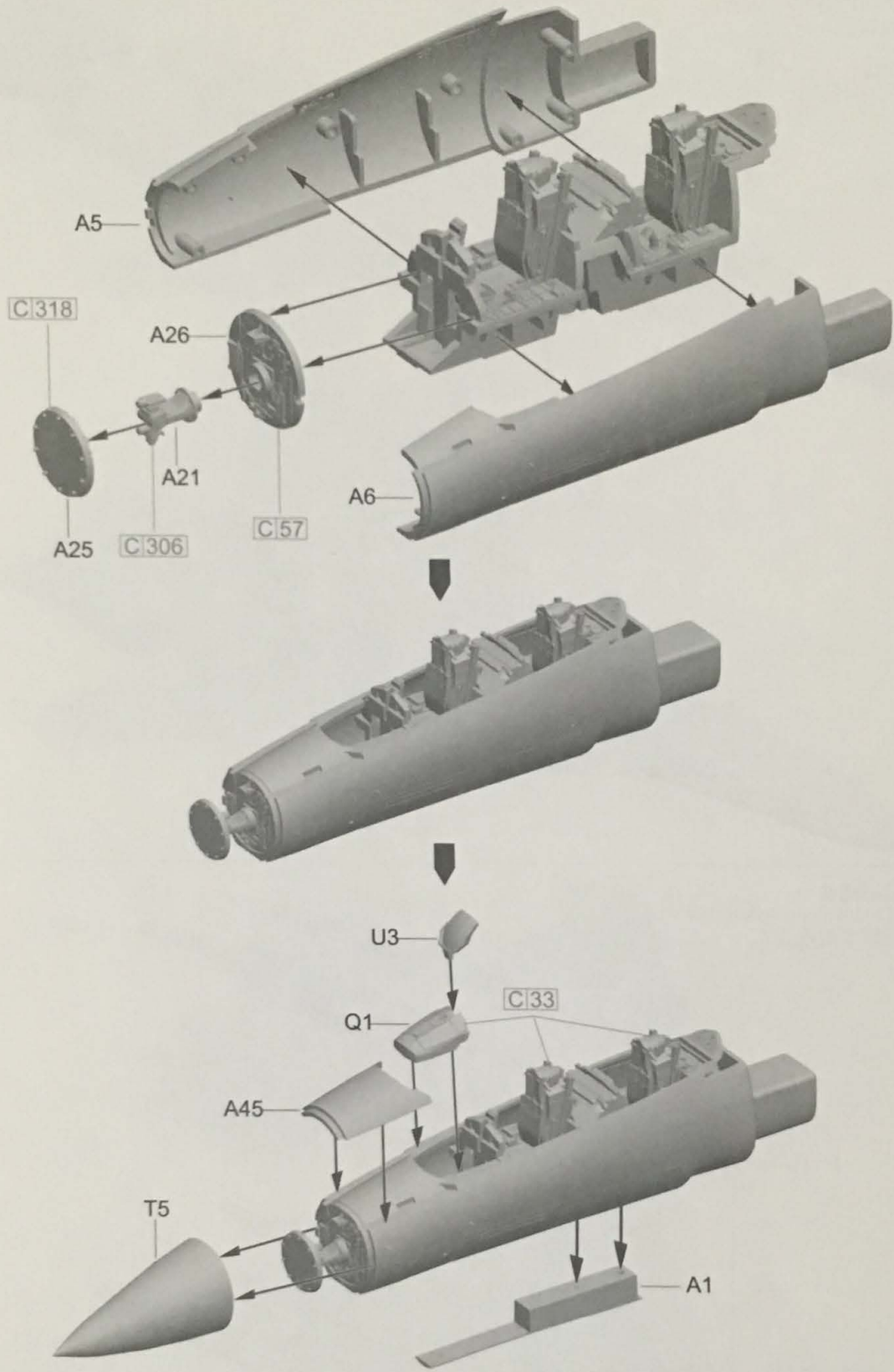

3

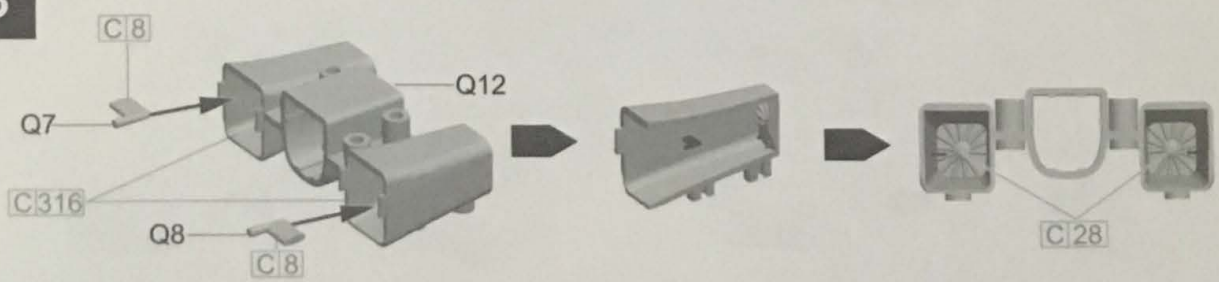

4

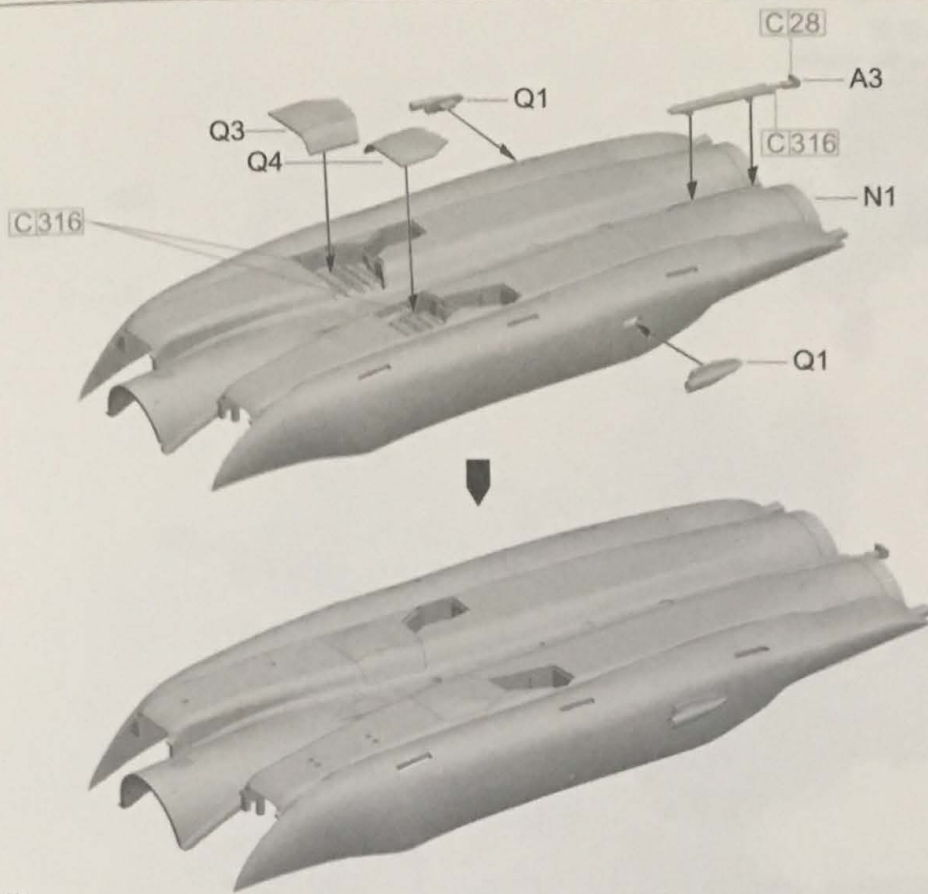

尾噴口組立
Exhaust Nozzle Assemble
ノズル組み立て

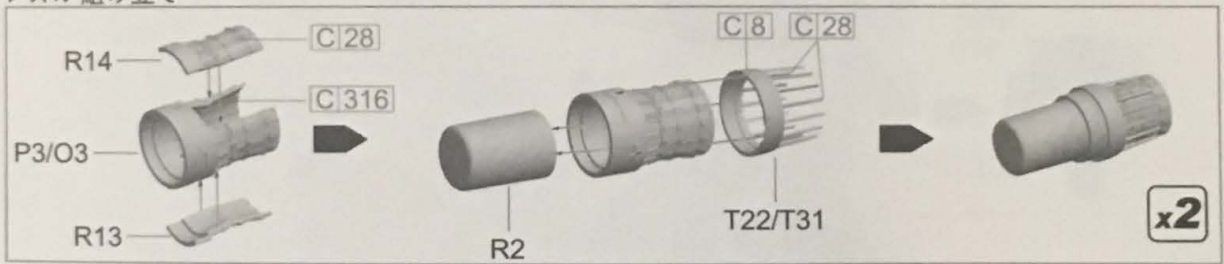

5

起飞降落状态組立
Gear Up Style Assemble
離陸状態組み立て

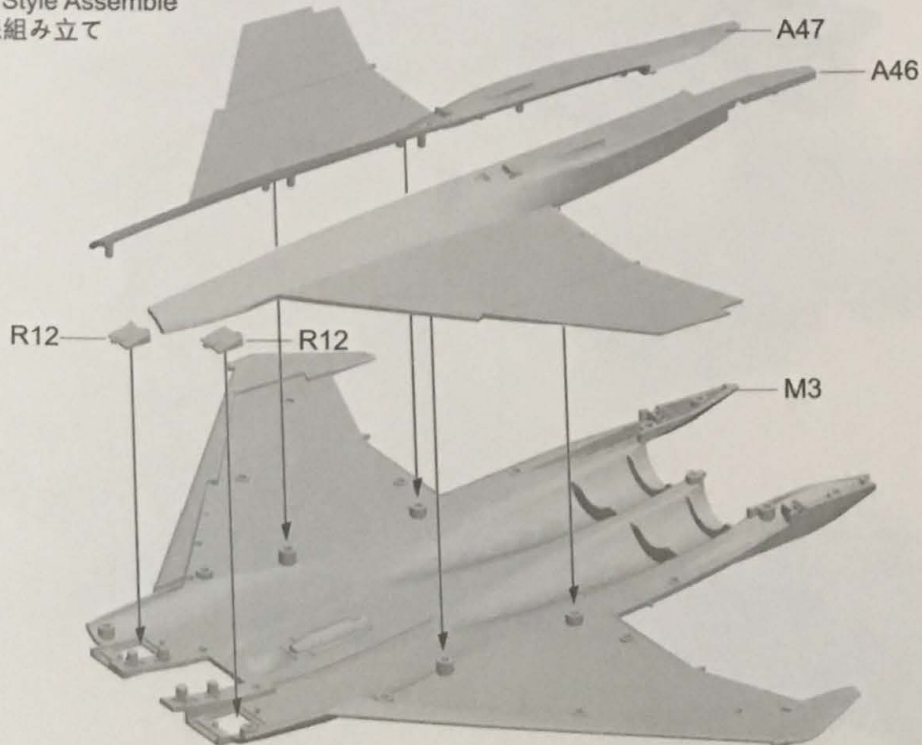

5

起飞降落状态组装
Gear Up Style Assemble
離陸状態組み立て

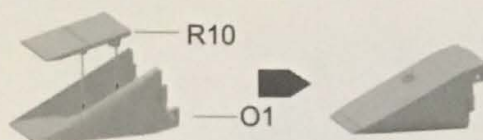

Left

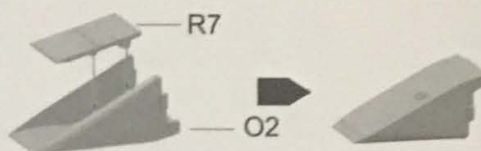

Right

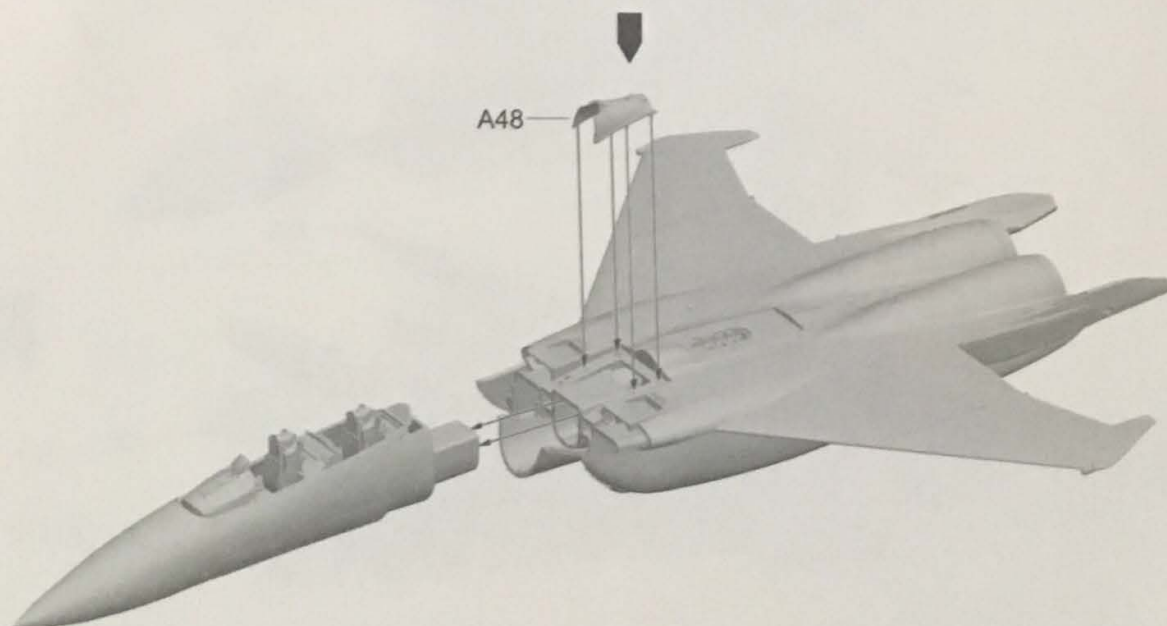
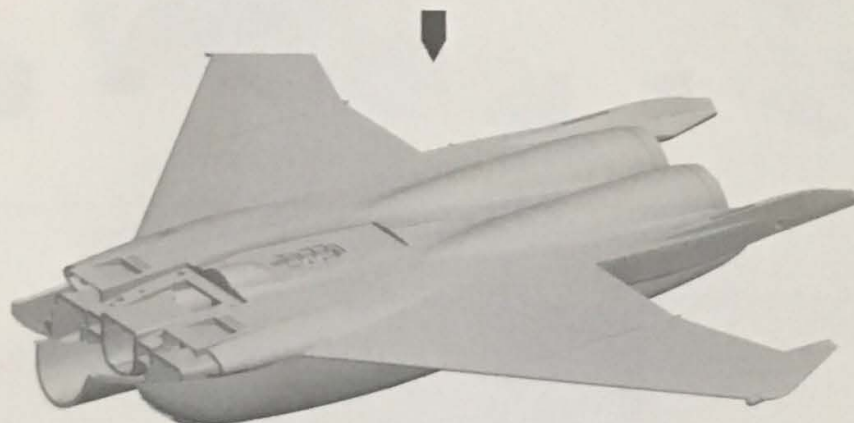
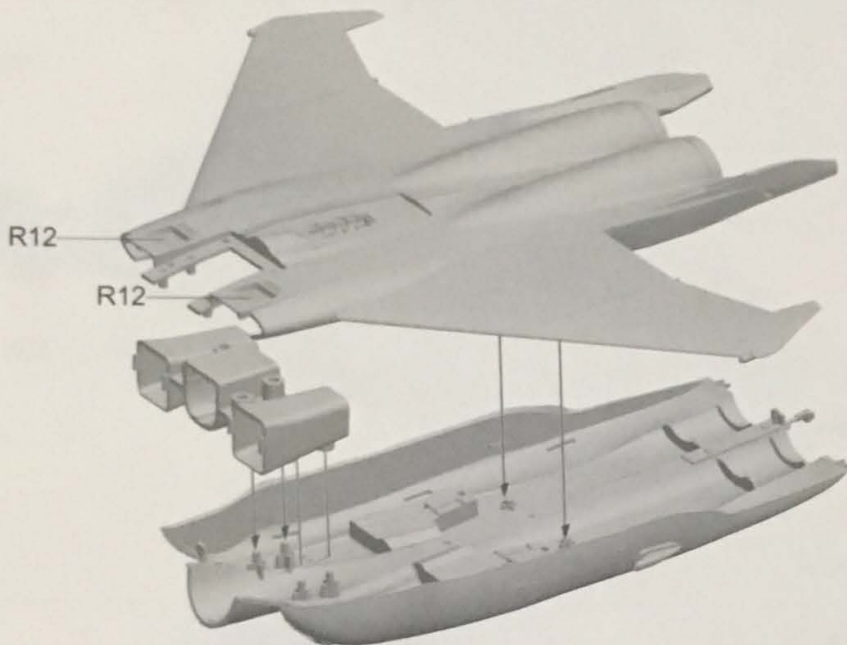

5

起飞降落状态组装
Gear Up Style Assemble
離陸状態組み立て



6

停机状态组装
Gear Down Style Assemble
停止状態の組み立て

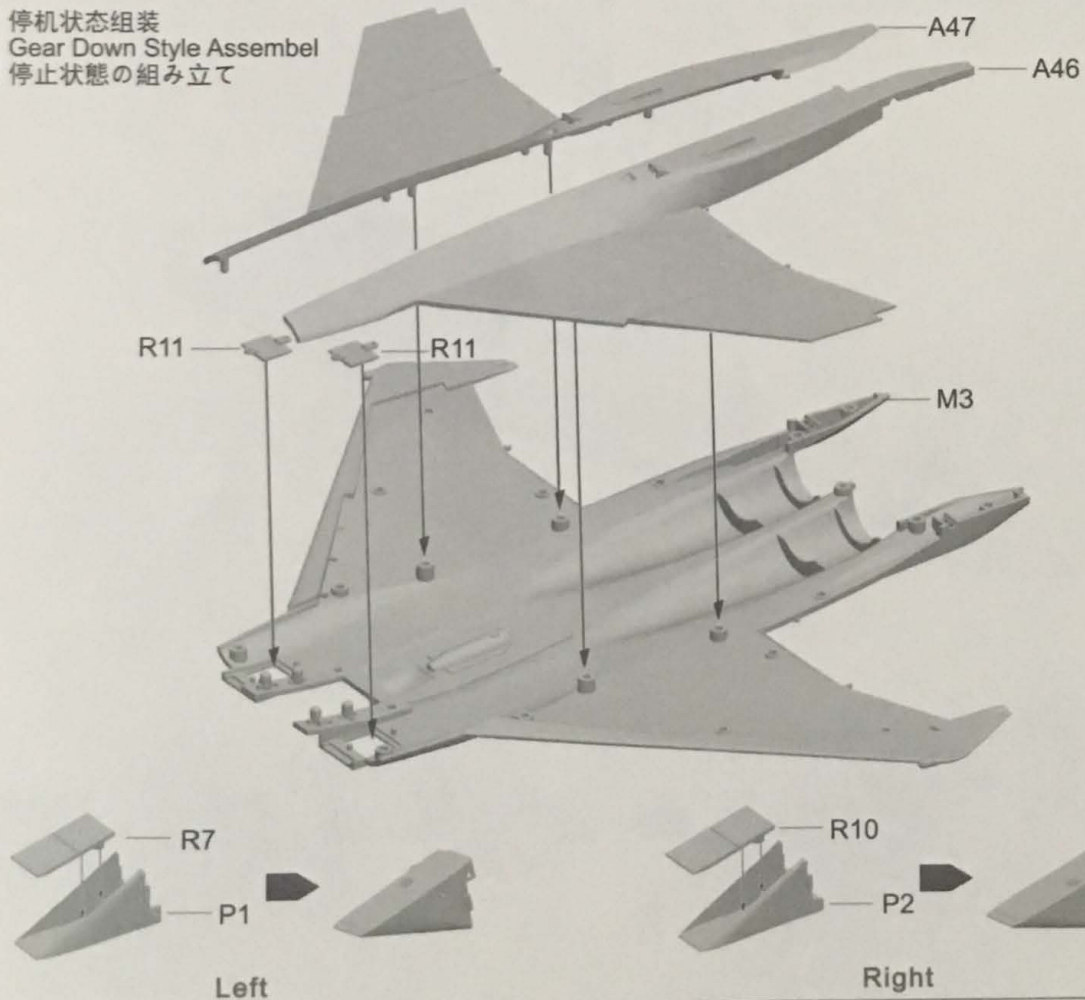

6

停机状态组装
Gear Down Style Assembl
停止状態の組み立て

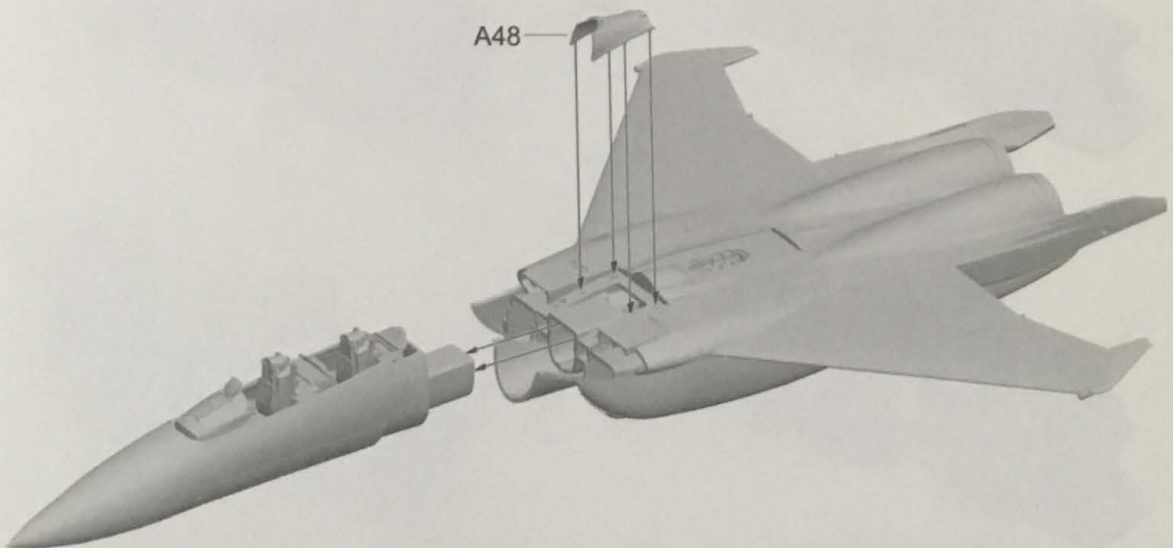
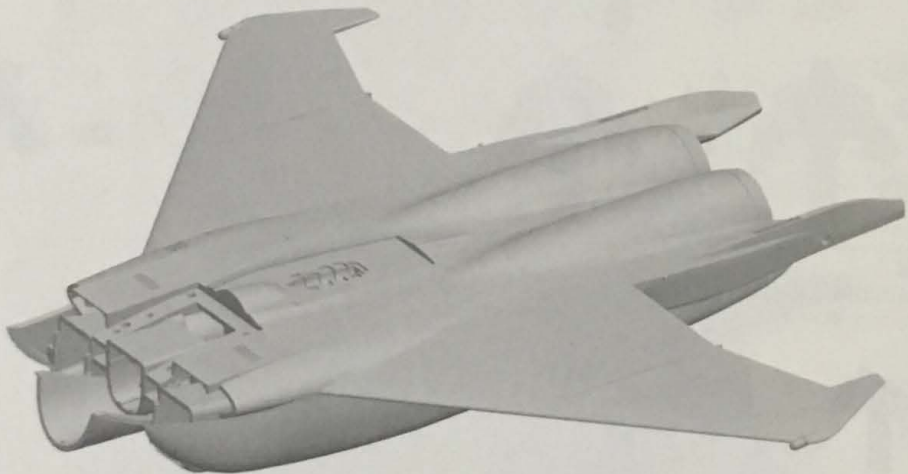
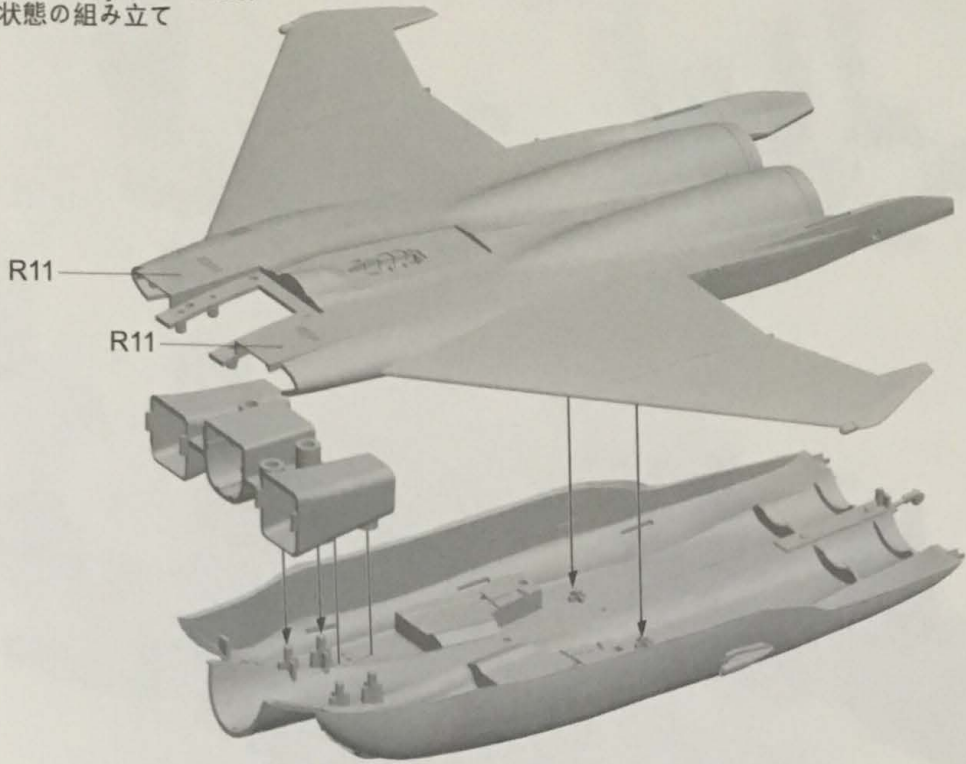

6

停机状态组装
Gear Down Style Assembl
停止状態の組み立て

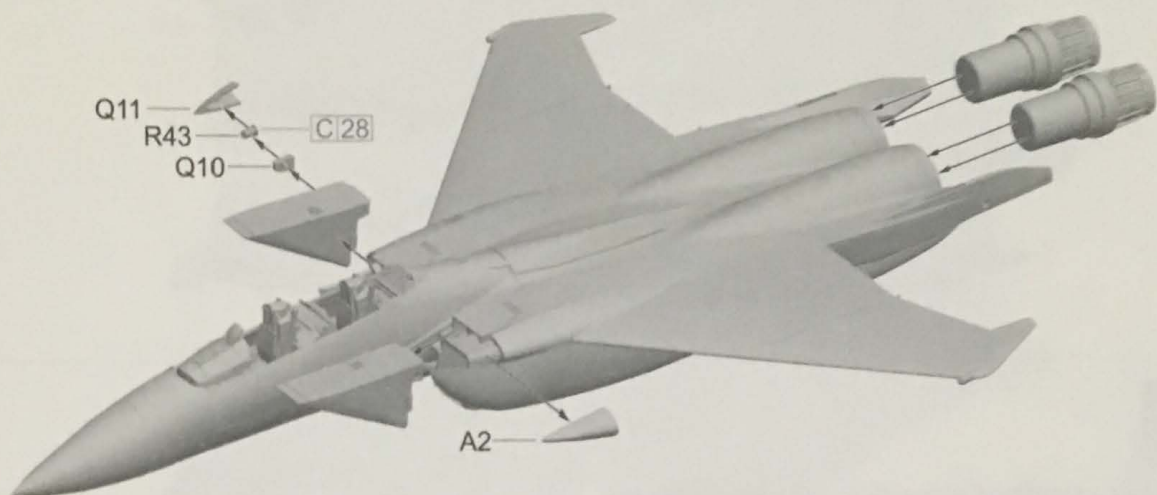

7

关闭状态
Retracted
開け状態

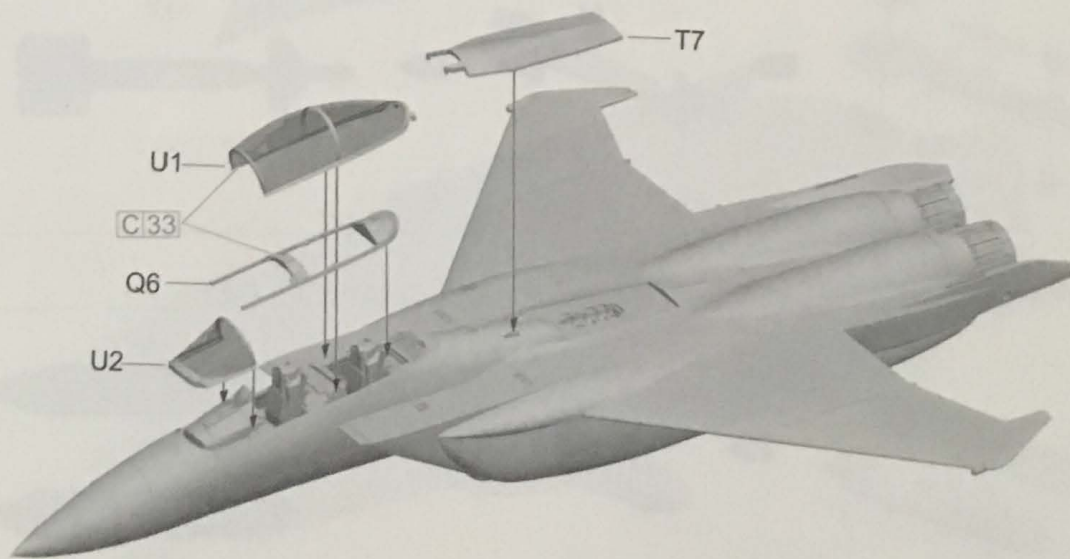

7 关闭状态
Retracted
閉け状態

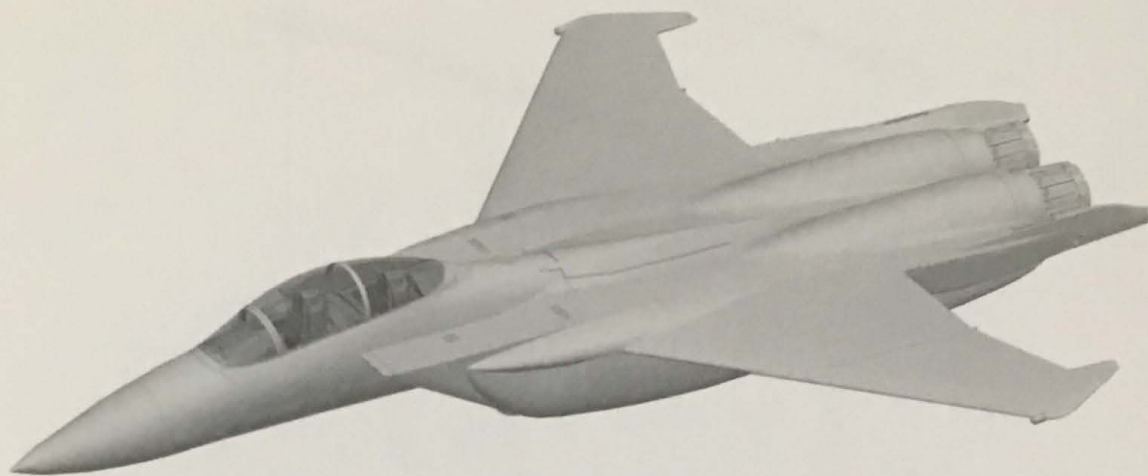

8 打开状态
Extended
開け状態

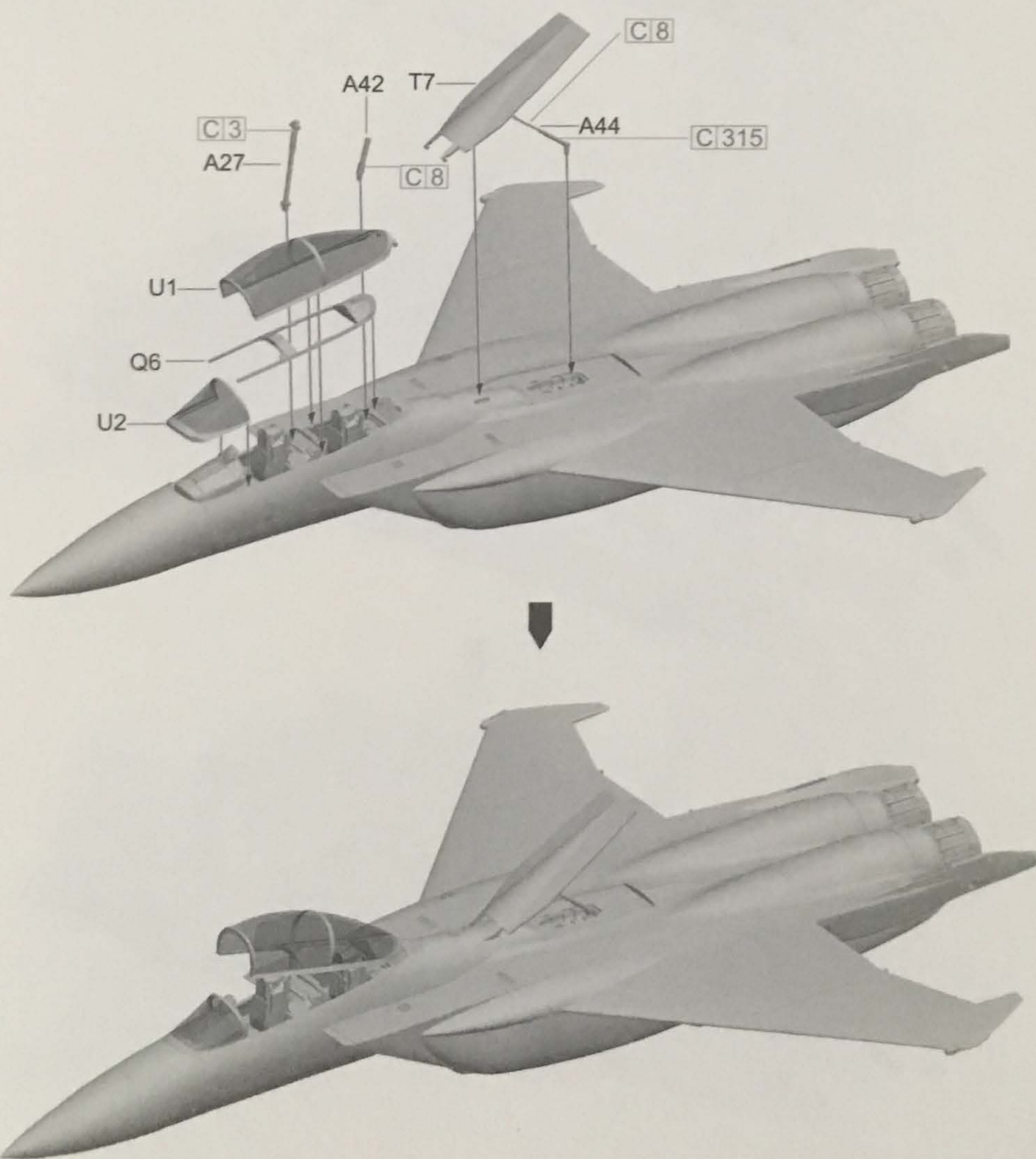

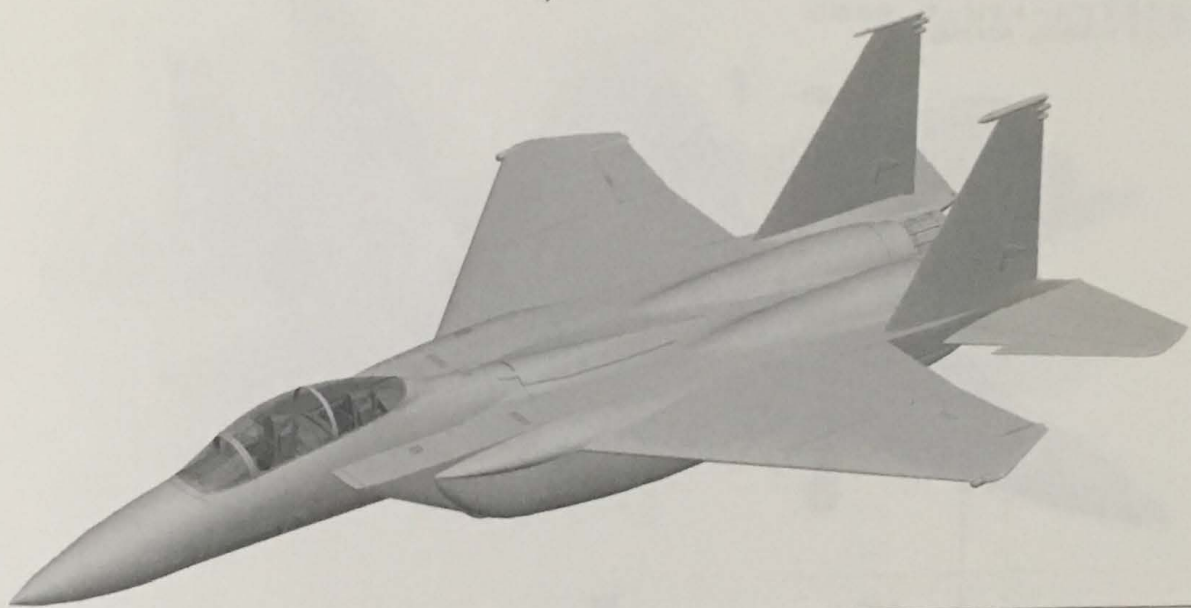
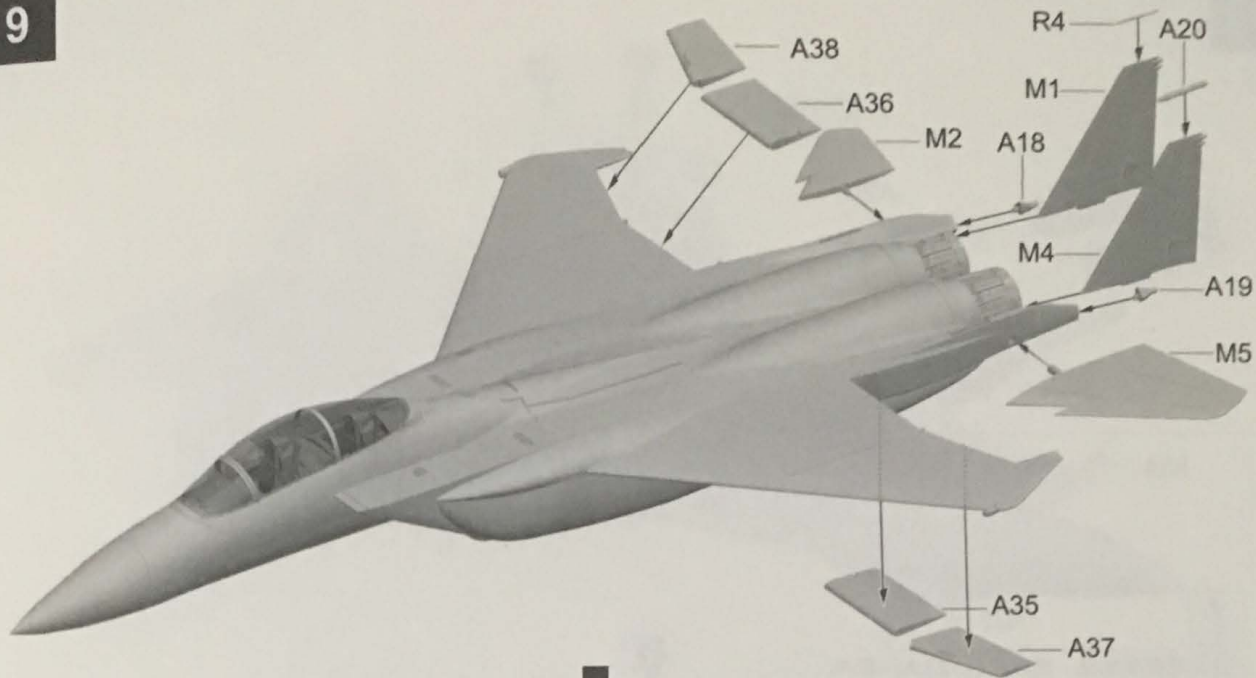



前轮
Nose Wheel
前輪

左后轮
Left Main Wheel
左の後輪

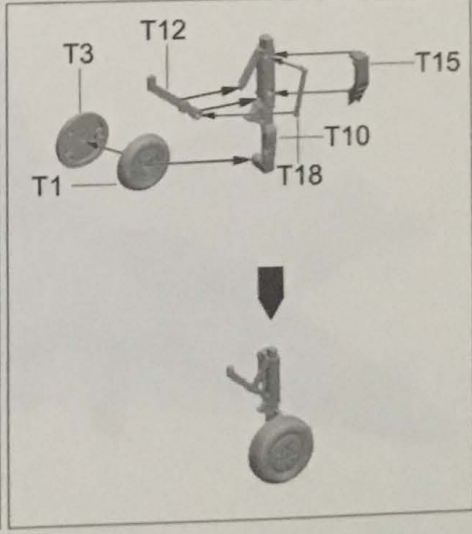
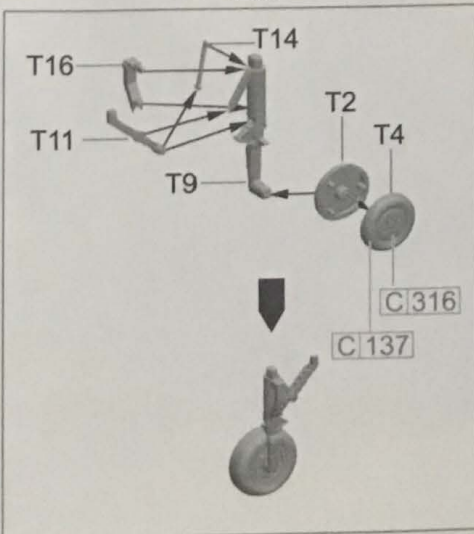
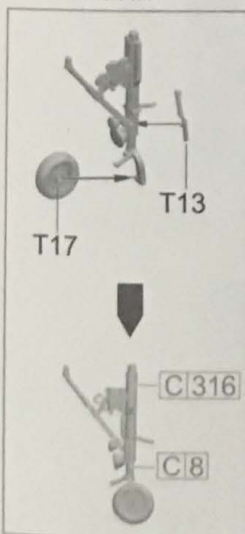
右后轮
Right Main Wheel
右の後輪

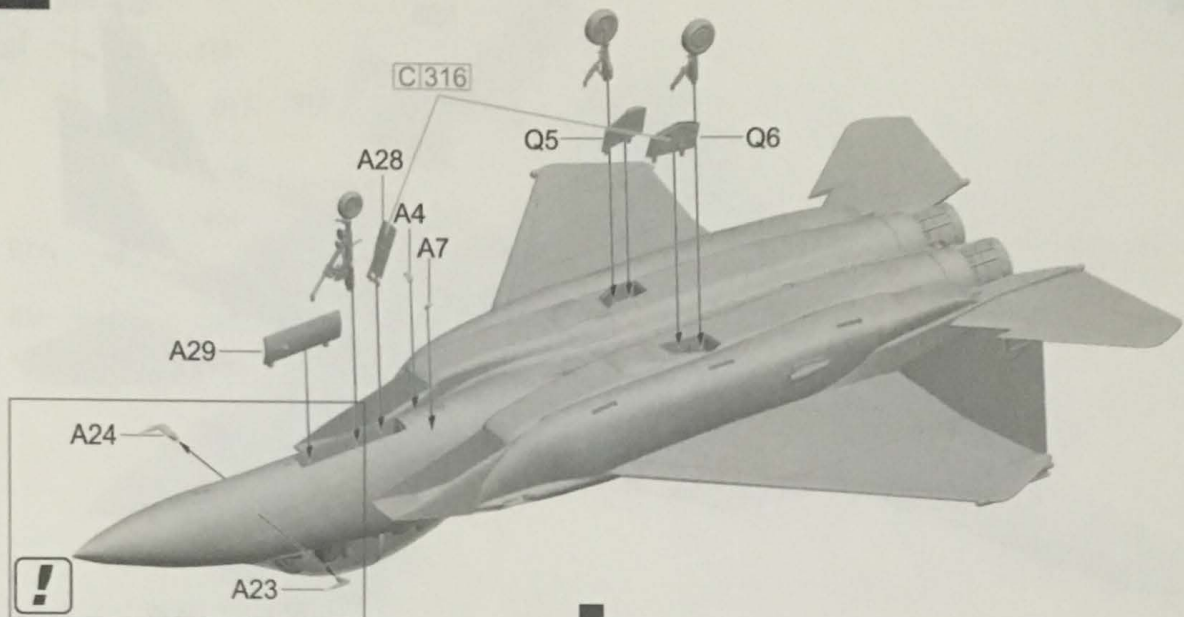



 此处先贴相关水贴，然后安装A23,A24零件。
 Apply relevant decals before install part A23 and A24.
 ここでまずデカールを貼って、それから
 インストールA23、A24部品。

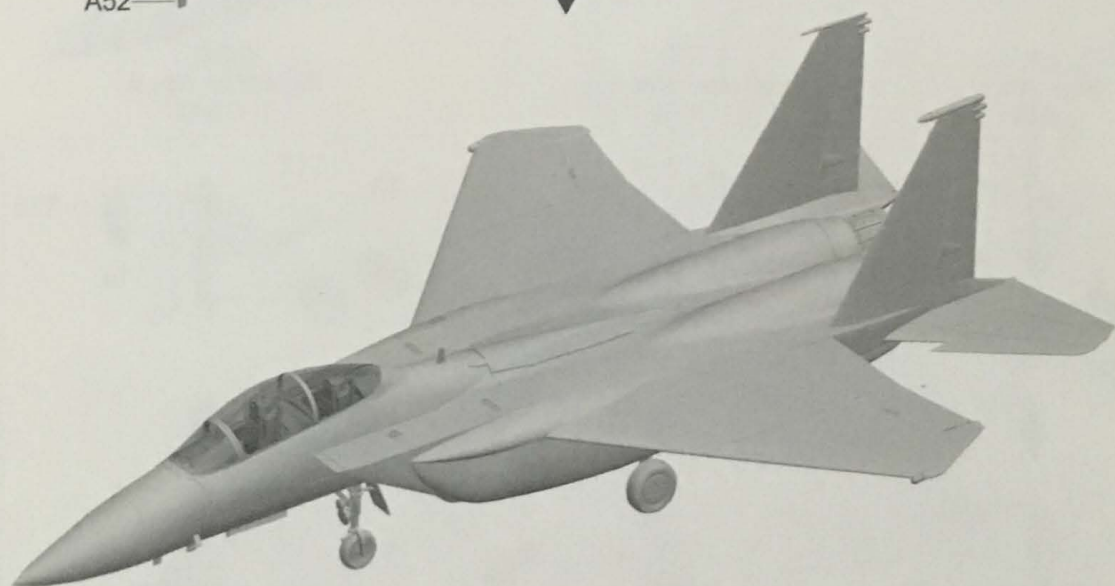
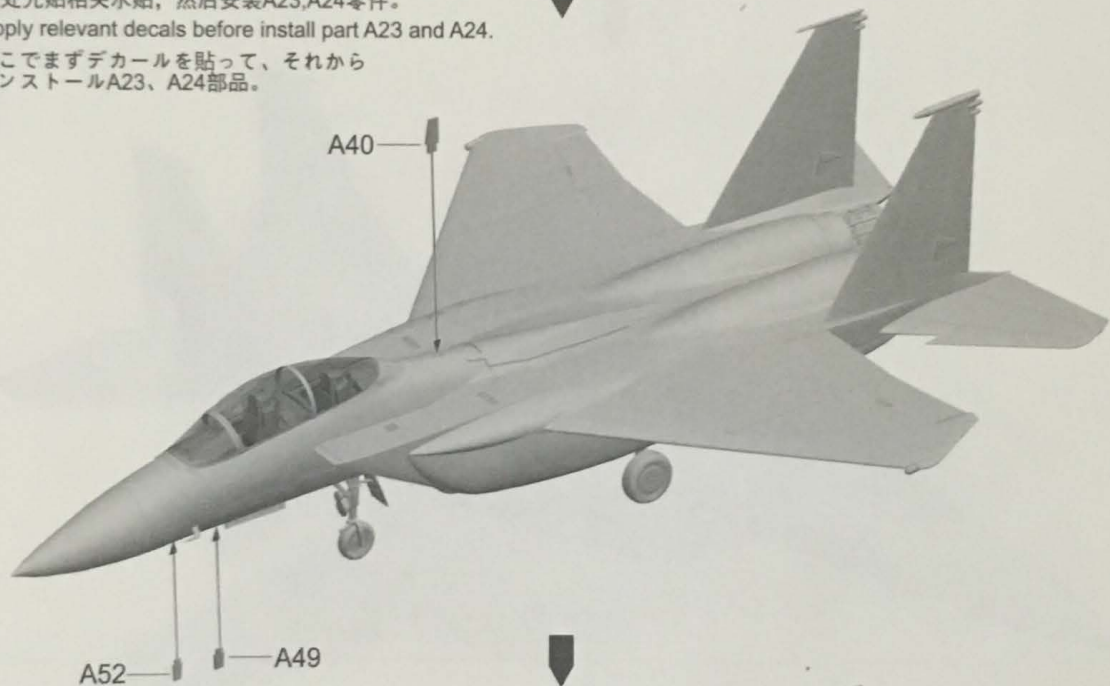

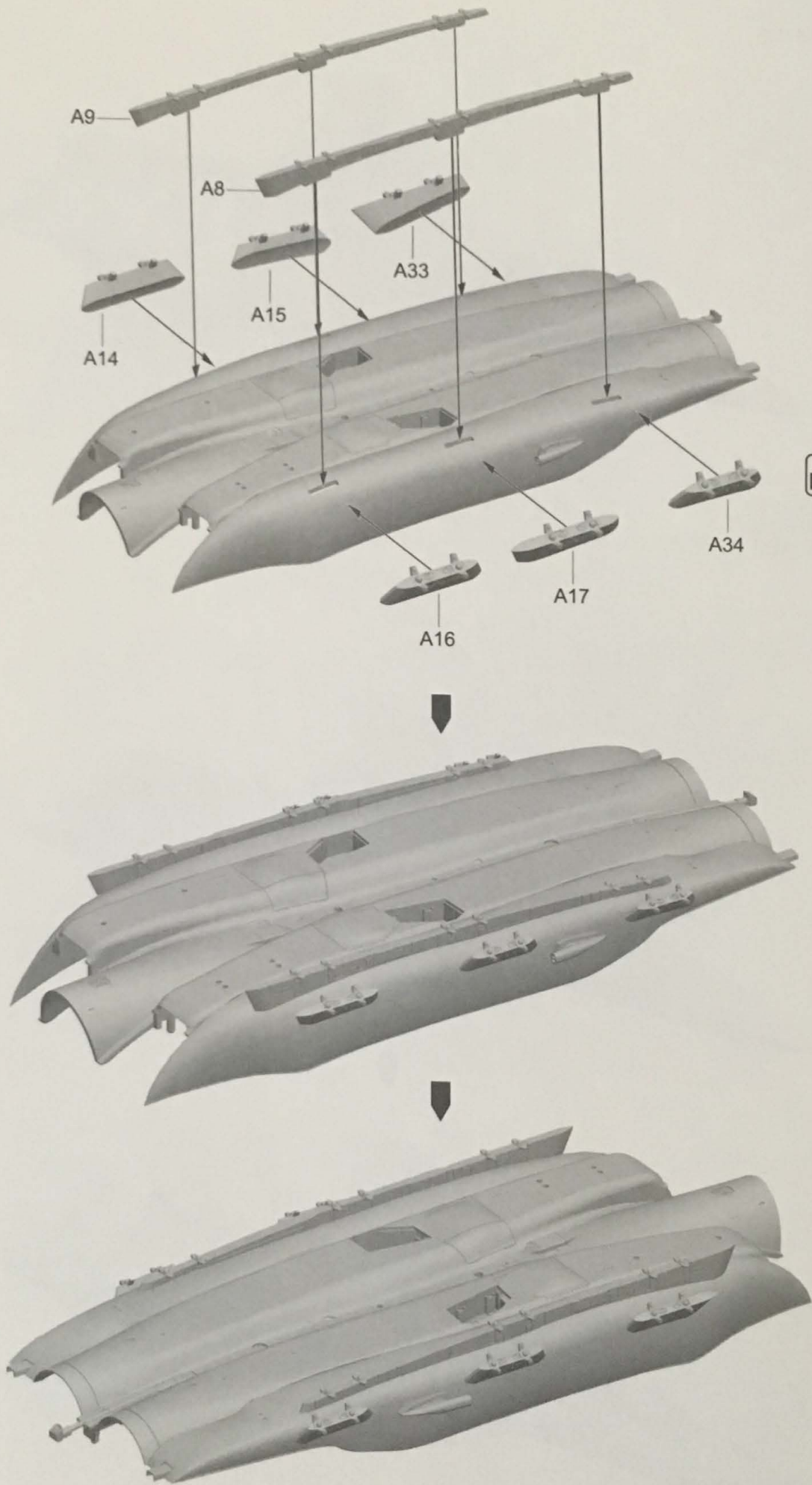

12



13

AIM-120B先进中距空空导弹 · AIM-120 AMRAAM

X2

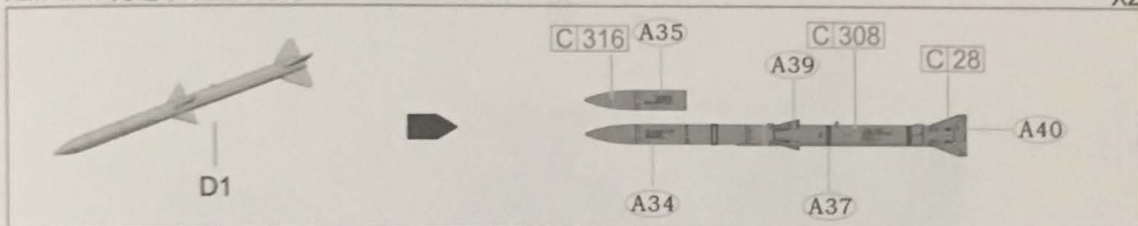

AIM-9L响尾蛇格斗导弹 · AIM-9L "Sidewinder" Short Range Air-to-Air Missile · AIM-9Lサイドワインダー

X2

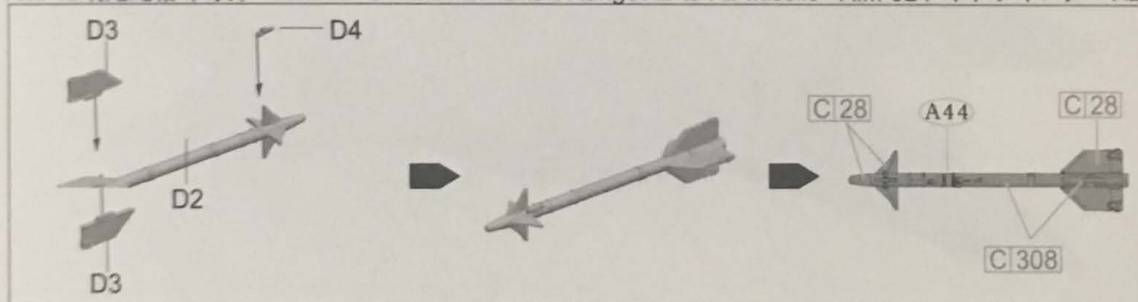

GBU-24激光制导炸弹 · GBU-24 Laser Guided Bomb · GBU-24 ペイブウェイIII誘導爆弾

X1

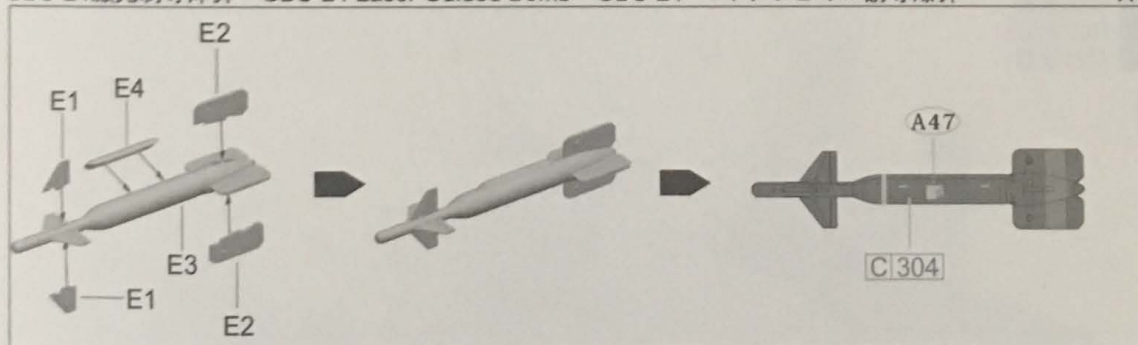

AN/AXQ-14数据指令吊舱 · AN/AXQ-14 Data-link Pod · AN/AXQ-14データリンクポッド

X1

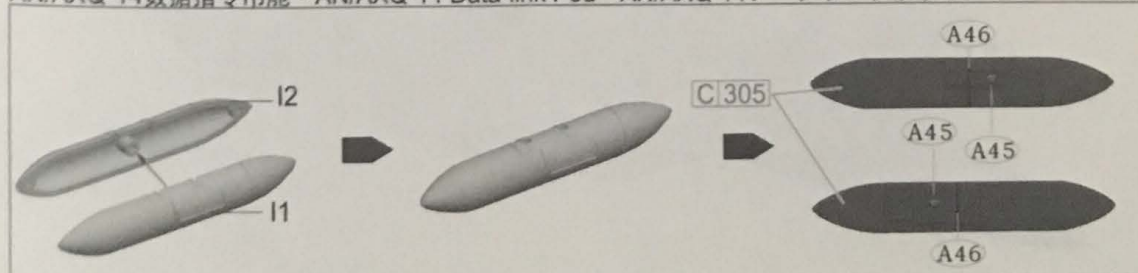

AN/AAQ-14目标指示吊舱 · AN/AAQ-14 Targeting Pod · AN/AAQ-14照準ポッド

X1

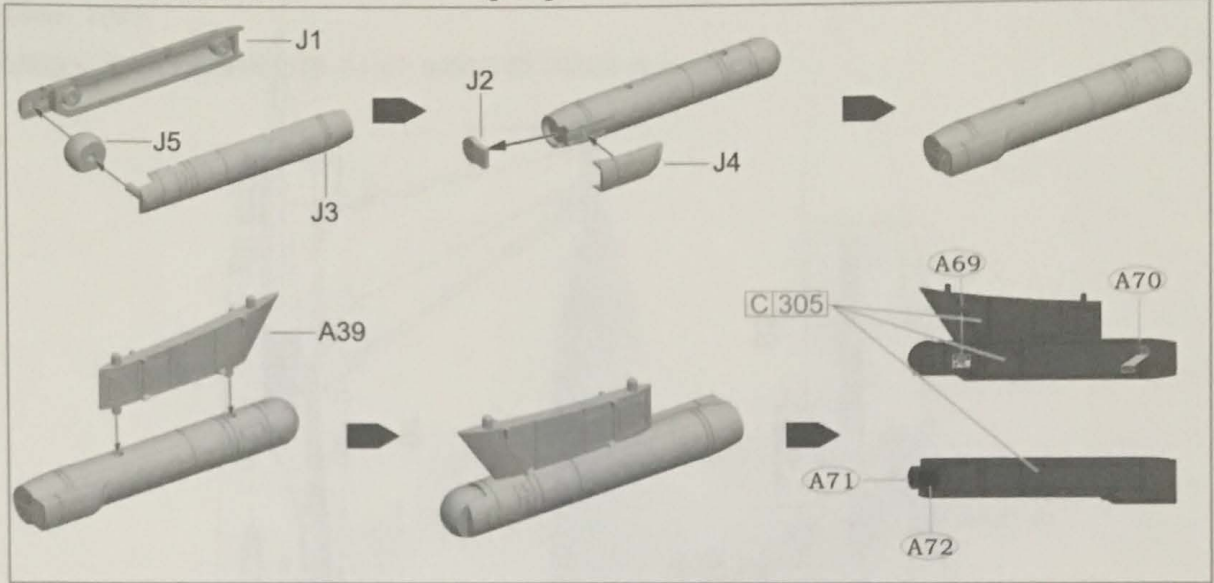

AN/AAQ-13低空导航吊舱 · AN/AAQ-13 Navigation Pod · AN/AAQ-13航法ポッド

X1

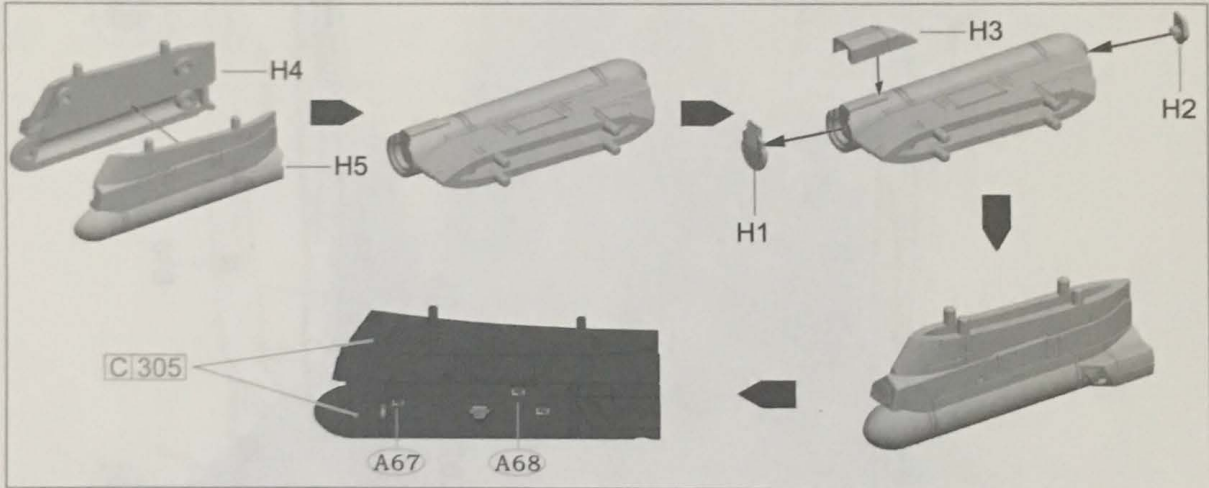

GBU-15电视制导炸弹 · GBU-15 TV-Guided Bomb · GBU-15誘導爆弾

X1

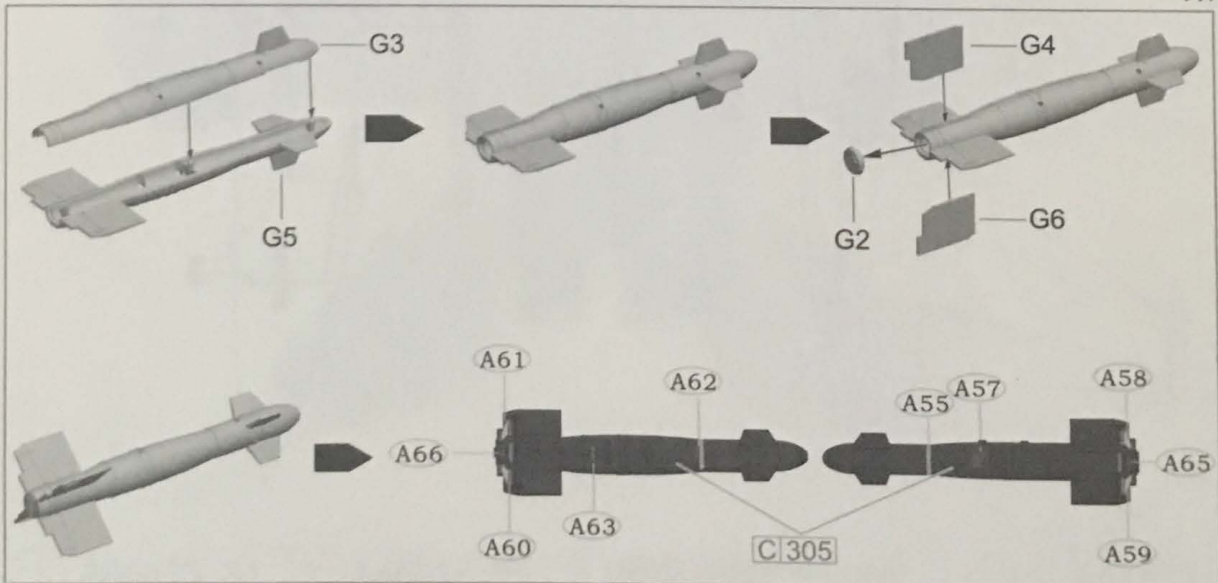

13

610副油箱・610Drop Tank・610ガロン増槽

X2

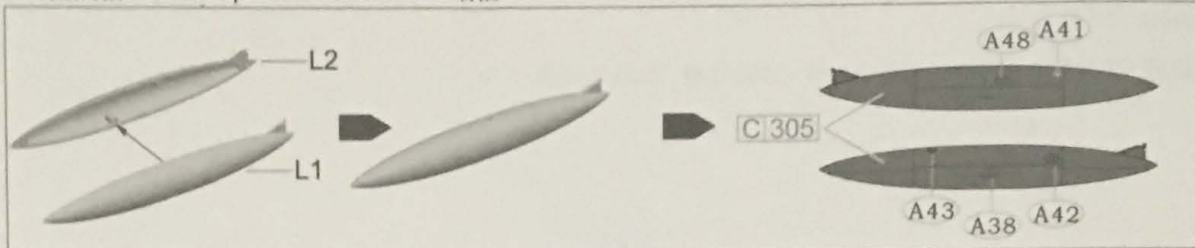

GBU-12激光制导炸弹・GBU-12 Laser Guided Bomb・GBU-12 ペイプウェイII誘導爆弾

X3

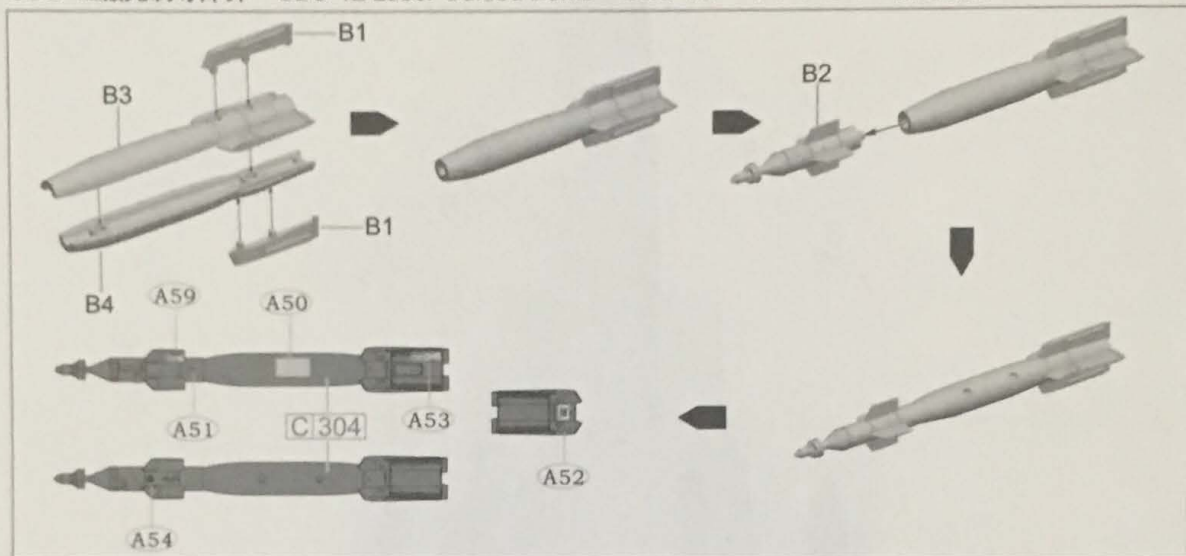

14

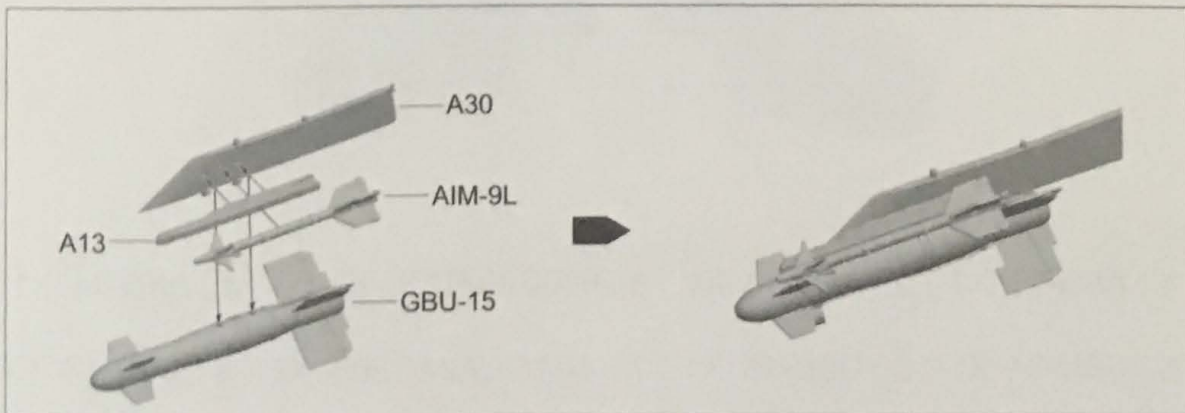
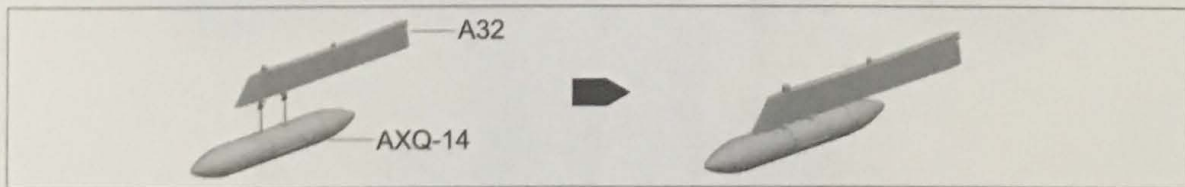
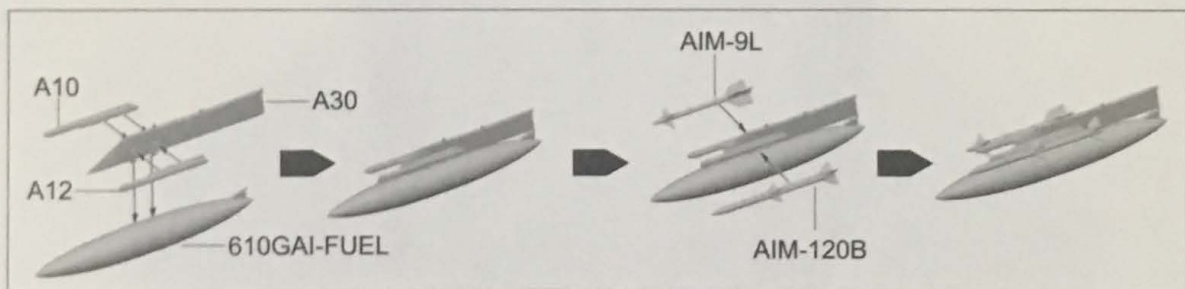

F-15E “攻击鹰” 87-0173号机 “鲨鱼嘴” 美国空军366联队391中队 (“两虎”中队) 美国爱达荷州芒廷霍姆基地 (MO)2002年;

F-15E Strike Eagle 87-0173 'Shark Mouth', 391st Fighter Squadron 'Bold Tigers', 366th Fighter Wing, U.S.A.F Mountain Home AFB, Idaho, 2002

第366戦闘航空団第391戦闘飛行隊 MO:87-0173号機 2002年アイダホ

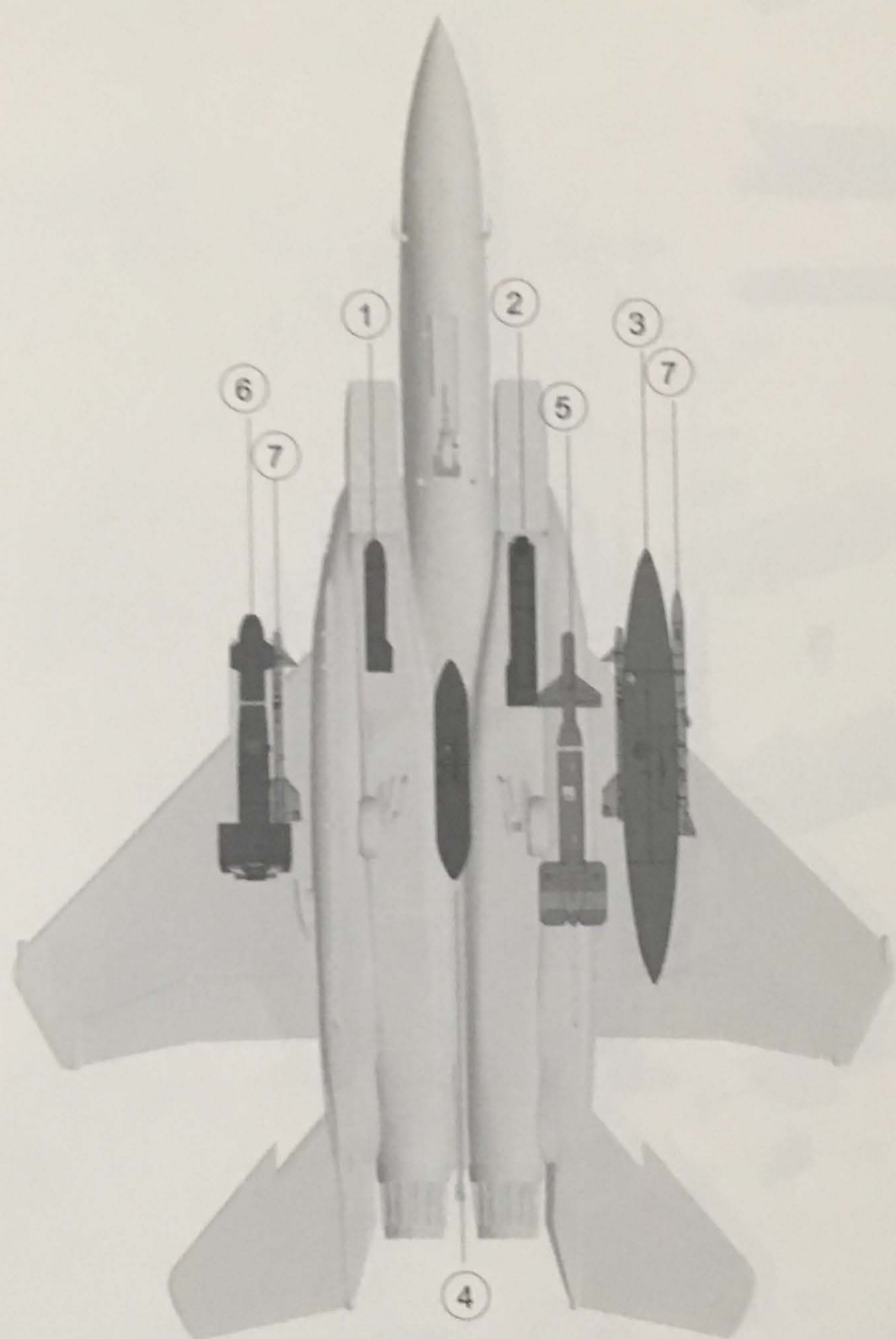

- ① AAQ-13 X1 ② AAQ-14 X1 ③ 610GAI-FUEL X2 ④ AXQ-14 X1
⑤ GBU-24 X1 ⑥ GBU-15 X1 ⑦ AIM-9L/AIM-120B X2 ⑧ GBU-12 X3

F-15E “攻击鹰” 87-0169号机“911纪念涂装--虎头” 美国空军366联队391中队 (“勇虎”中队) 美国爱达荷州芒廷霍姆基地(MO)2002年;

F-15E Strike Eagle 87-0169 'Tiger Lead', 391st Fighter Squadron 'Bold Tigers', 366th Fighter Wing, U.S.A.F Mountain Home AFB, Idaho, 2002

第336戦闘航空団第391戦闘飛行隊 MO:87-0169号機 2002年アイダホ

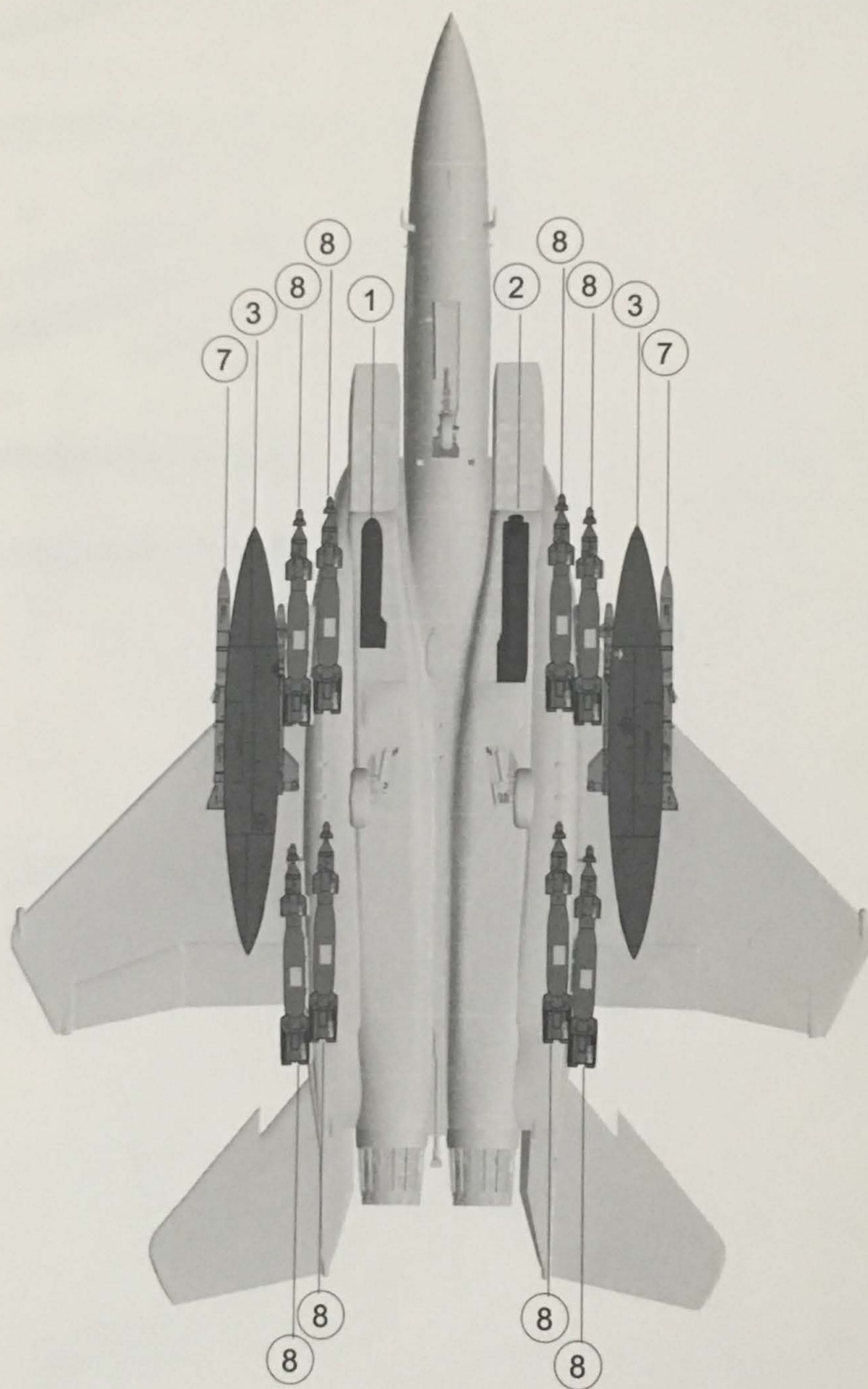

- ① AAQ-13 X1 ② AAQ-14 X1 ③ 610GAI-FUEL X2 ④ AXQ-14 X1
⑤ GBU-24 X1 ⑥ GBU-15 X1 ⑦ AIM-9L/AIM-120B X2 ⑧ GBU-12 X3

F-15E-47-MC "攻击鹰"89-0488号机"火箭快递", 垂尾代码" SJ", 美国空军第4联队336中队 ("火箭人"中队), 卡塔尔 阿尔·乌代德空军基地, 2003年

F-15E-47-MC Strike Eagle 'Rocket Express' 89-0488 SJ 336th FS 'Rocketeers', 4thTFW, U.S.A.F, Al Udeid AB, Qatar 2003

第4戦闘航空団第336戦闘飛行隊 SJ:89-0488号機 2003年カタール

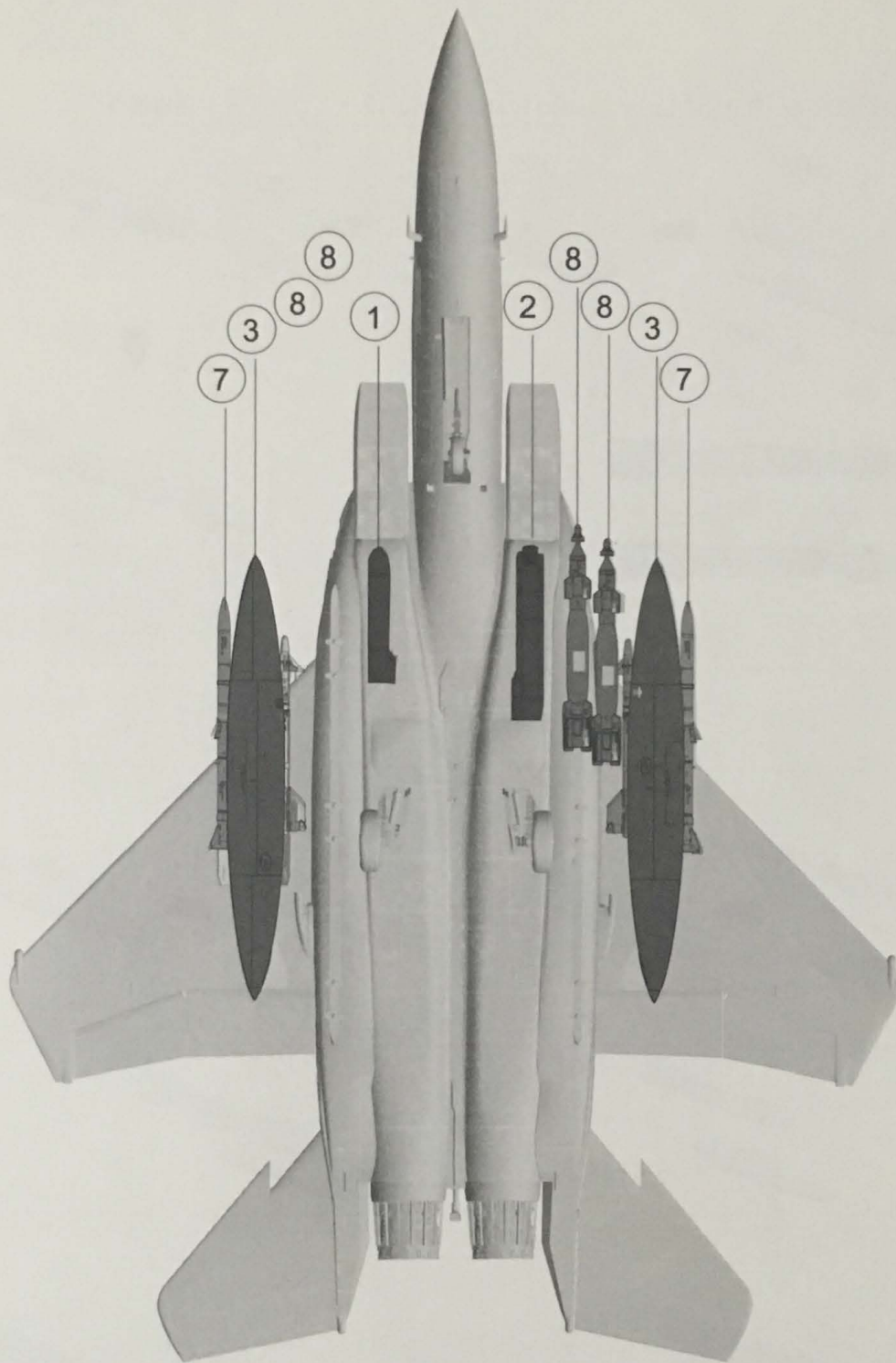

- | | | | |
|-------------|-------------|----------------------|-------------|
| ① AAQ-13 X1 | ② AAQ-14 X1 | ③ 610GAI-FUEL X2 | ④ AXQ-14 X1 |
| ⑤ GBU-24 X1 | ⑥ GBU-15 X1 | ⑦ AIM-9L/AIM-120B X2 | ⑧ GBU-12 X3 |

通用水贴涂装指示 (侧面)

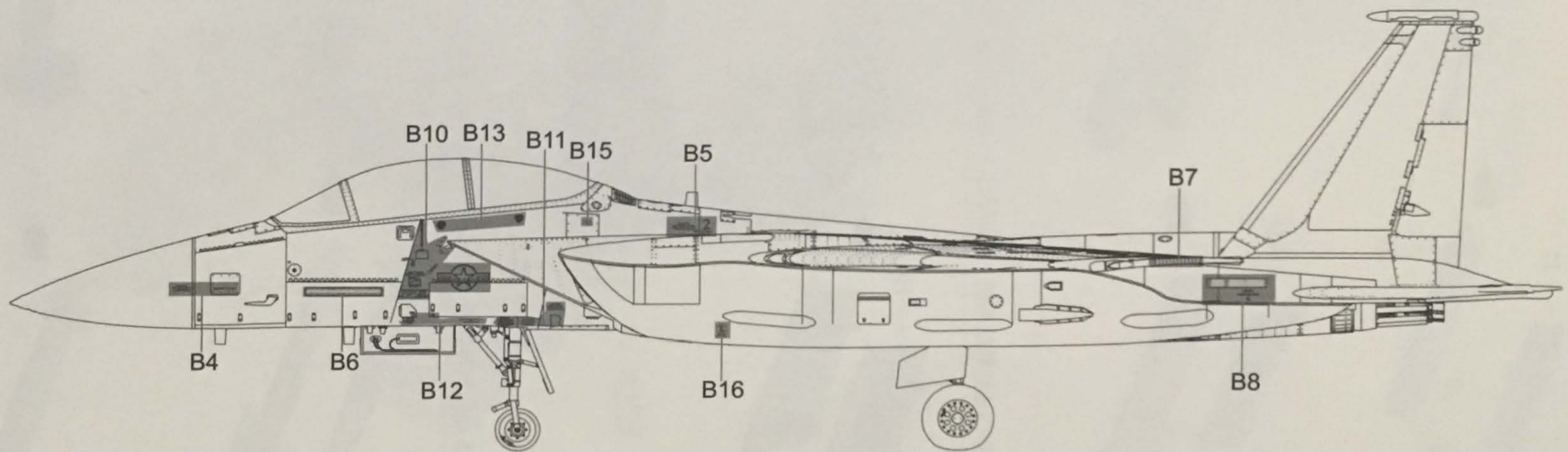
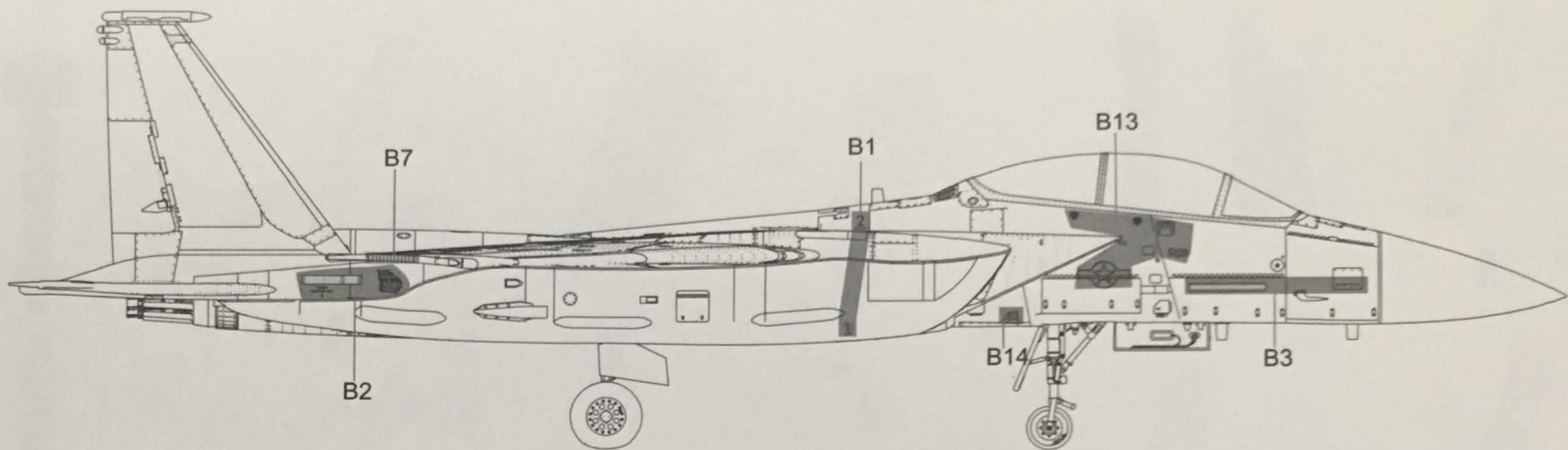

0173: F-15E 87-0173号机 “鲨鱼嘴” 美国空军366联队391中队 (“勇虎” 中队) 美国爱达荷州芒廷霍姆基地(MO)2002年
 F-15E 87-0173 'Shark Mouth', 391st Fighter Squadron 'Bold Tigers', 366th Fighter Wing, U.S.A.F Mountain Home AFB, Idaho, 2002



0169: F-15E 87-0169号机 “911纪念涂装一虎头” 美国空军366联队391中队 (“勇虎” 中队) 美国爱达荷州芒廷霍姆基地(MO)2002年
 F-15E 87-0169 'Tiger Lead', 391st Fighter Squadron 'Bold Tigers', 366th Fighter Wing, U.S.A.F Mountain Home AFB, Idaho, 2002

0488: F-15E-47-MC 89-0488号机 美国空军第4联队336中队 (“火箭人” 中队), 卡塔尔 阿尔·乌代德空军基地, 2003年
 F-15E-47-MC 89-0488 336th FS 'Rocketeers', 4th TFW, U.S.A.F, Al Udeid AB, Qatar 2003

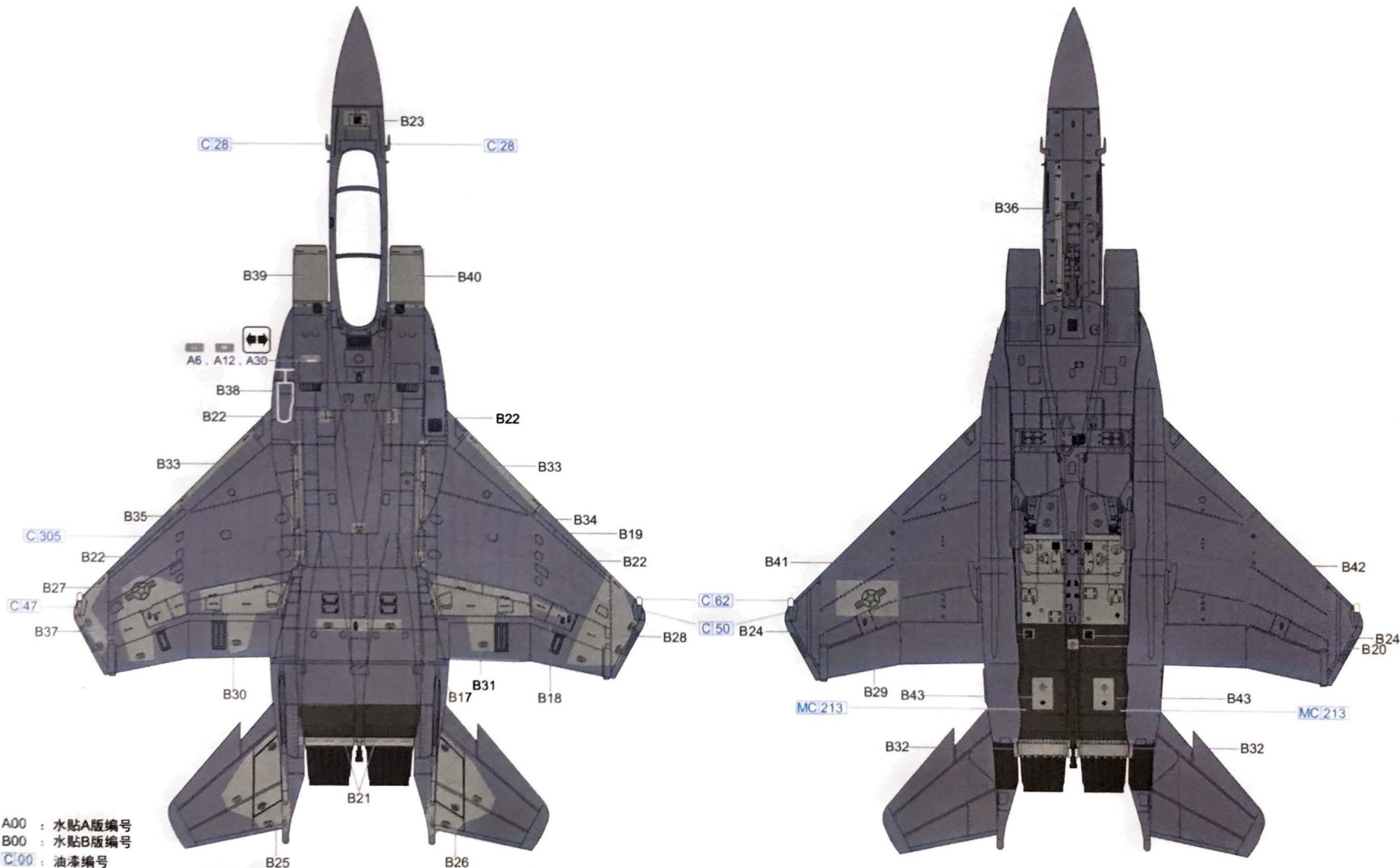

0173: F-15E 87-0173号机 “鲨鱼嘴” 美国空军366联队391中队 (“勇虎”中队) 美国爱达荷州芒廷霍姆基地(MO)2002年
 F-15E 87-0173 'Shark Mouth', 391st Fighter Squadron 'Bold Tigers', 366th Fighter Wing, U.S.A.F Mountain Home AFB, Idaho, 2002

A00 : 水贴A版编号
 B00 : 水贴B版编号
 C000 : 油漆编号

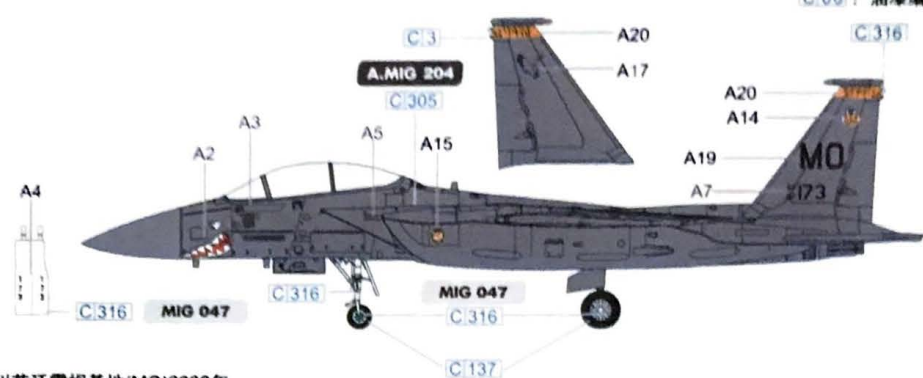

0169: F-15E 87-0169号机 “911纪念涂装一虎头” 美国空军366联队391中队 (“勇虎”中队) 美国爱达荷州芒廷霍姆基地(MO)2002年
 F-15E 87-0169 'Tiger Lead', 391st Fighter Squadron 'Bold Tigers', 366th Fighter Wing, U.S.A.F Mountain Home AFB, Idaho, 2002



0488: F-15E-47-MC 89-0488号机 美国空军第4联队336中队 (“火箭人”中队), 卡塔尔 阿尔·乌代德空军基地, 2003年
 F-15E-47-MC 89-0488 336th FS 'Rocketeers', 4th TFW, U.S.A.F, Al Udeid AB, Qatar 2003

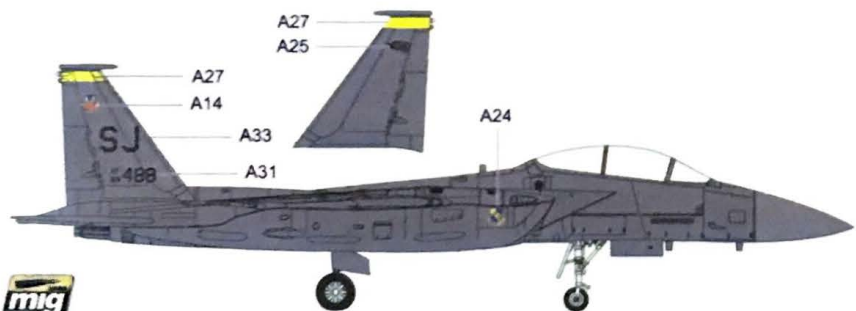

Color sets and profiles by

Painting and Marking Guide

- MIG 205 Gray
- MIG 047 Satin White
- MIG 046 Matt Black
- A.MIG 204 Medium Gunship Gray

