

1:700 SCALE MODERN SEA POWER SERIES

U.S.S. LAFFEY DD-459 1942

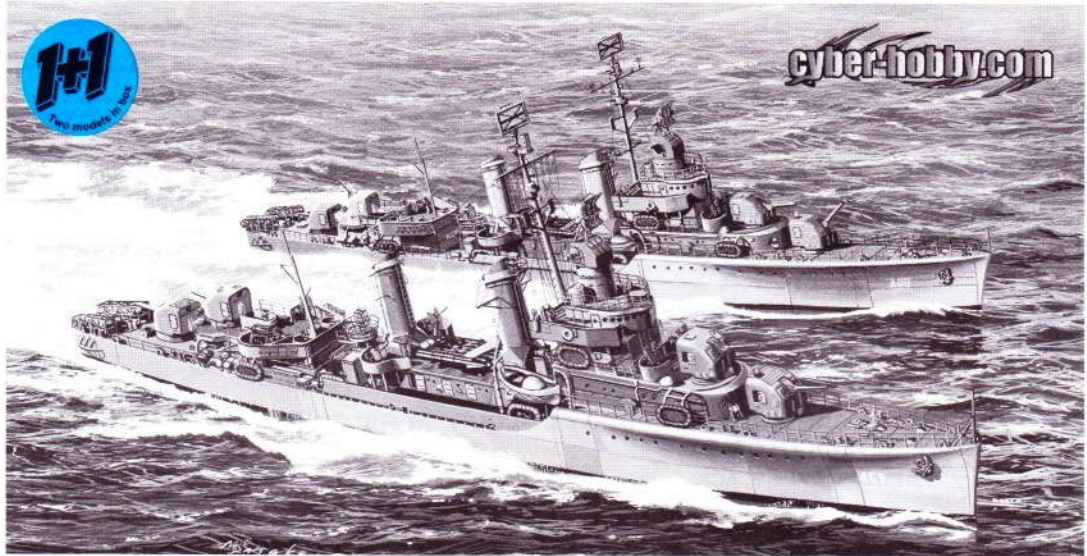

cyber-hobby.com



Project supervised by Timothy Dike.

KIT NO:7086

Cx2

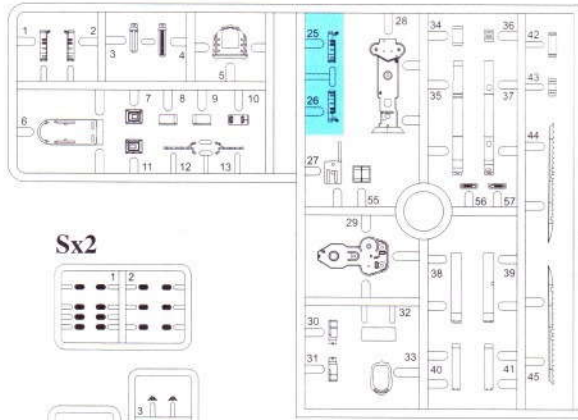

Ax2

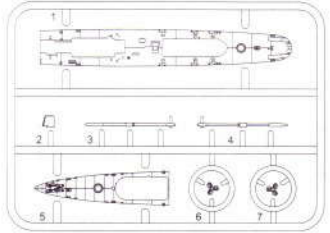

Sx2

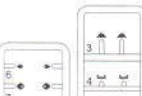
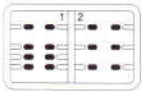

L



K



Jx4



Ix4



Dx2

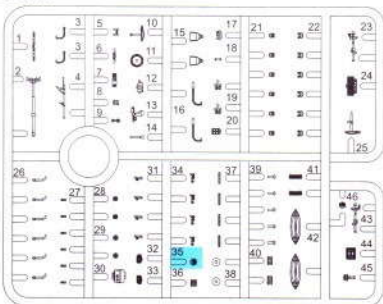

Hx4

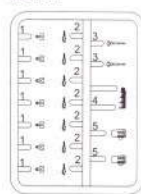

Fx4

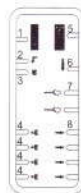

MAx2
(Photo-etched Parts)

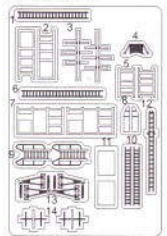

Z



※部品の使用に注意
Parts not for use
Teile werden nicht verwendet
Pieces a ne pas utiliser
Parti non utilizzabili
注意する部品のリスト

2

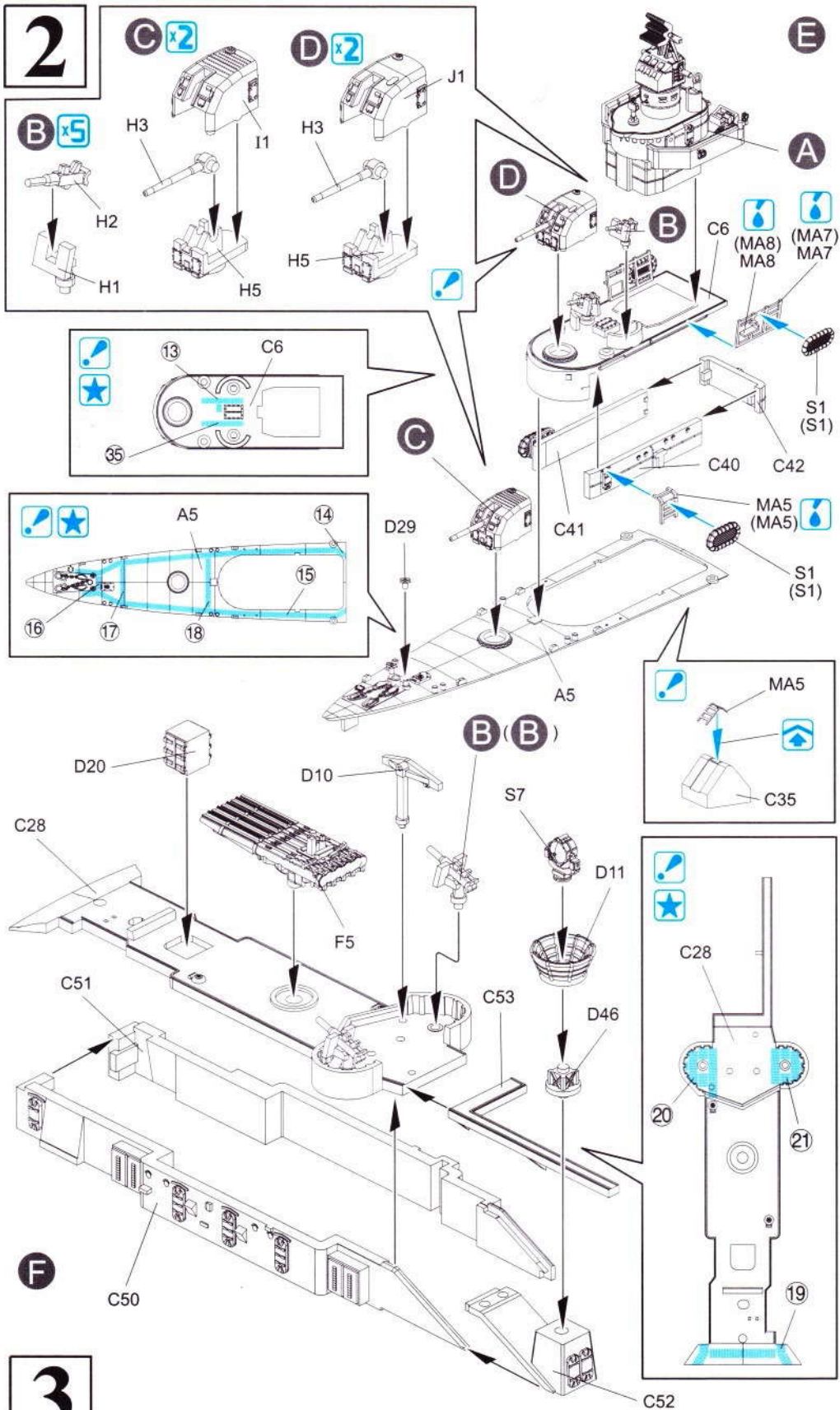

3

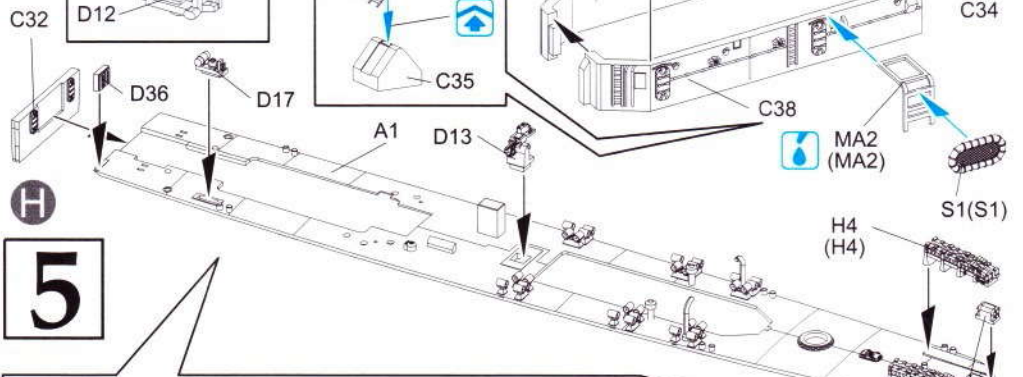
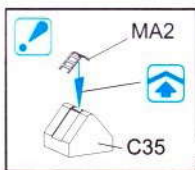
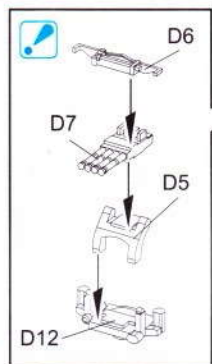
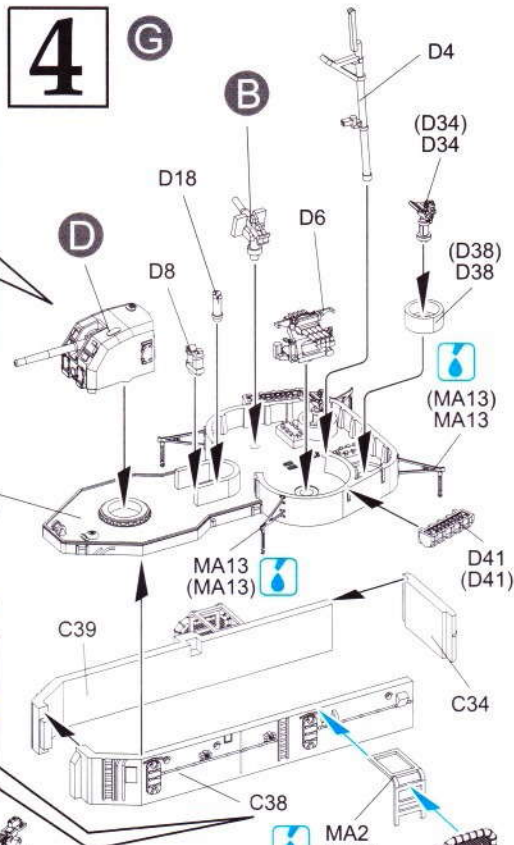
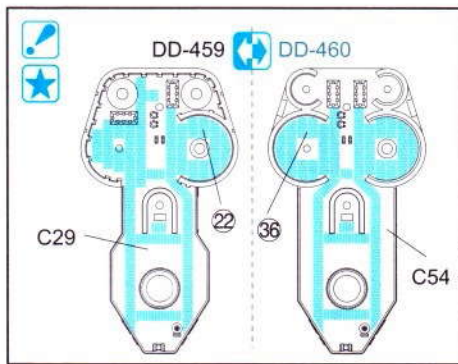

5

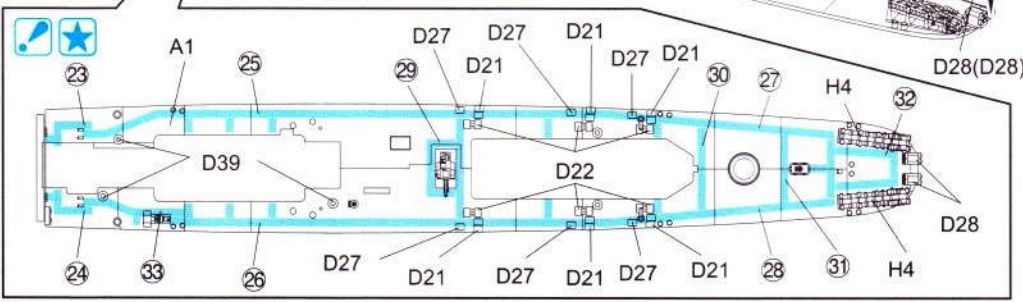

6

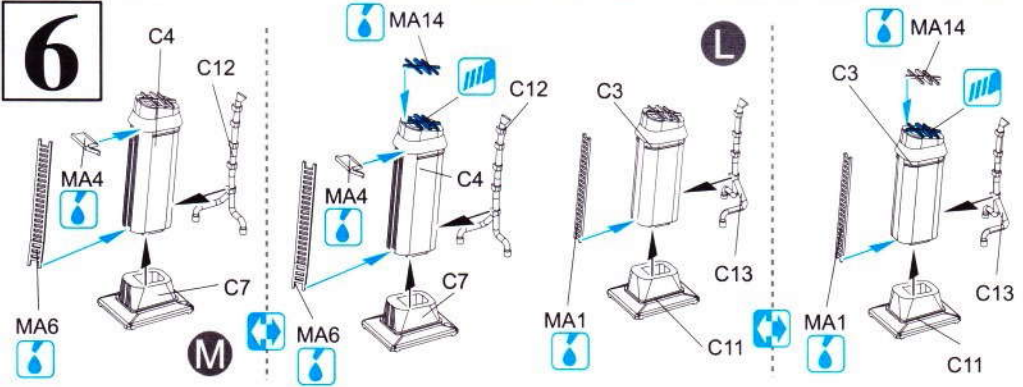

7

J

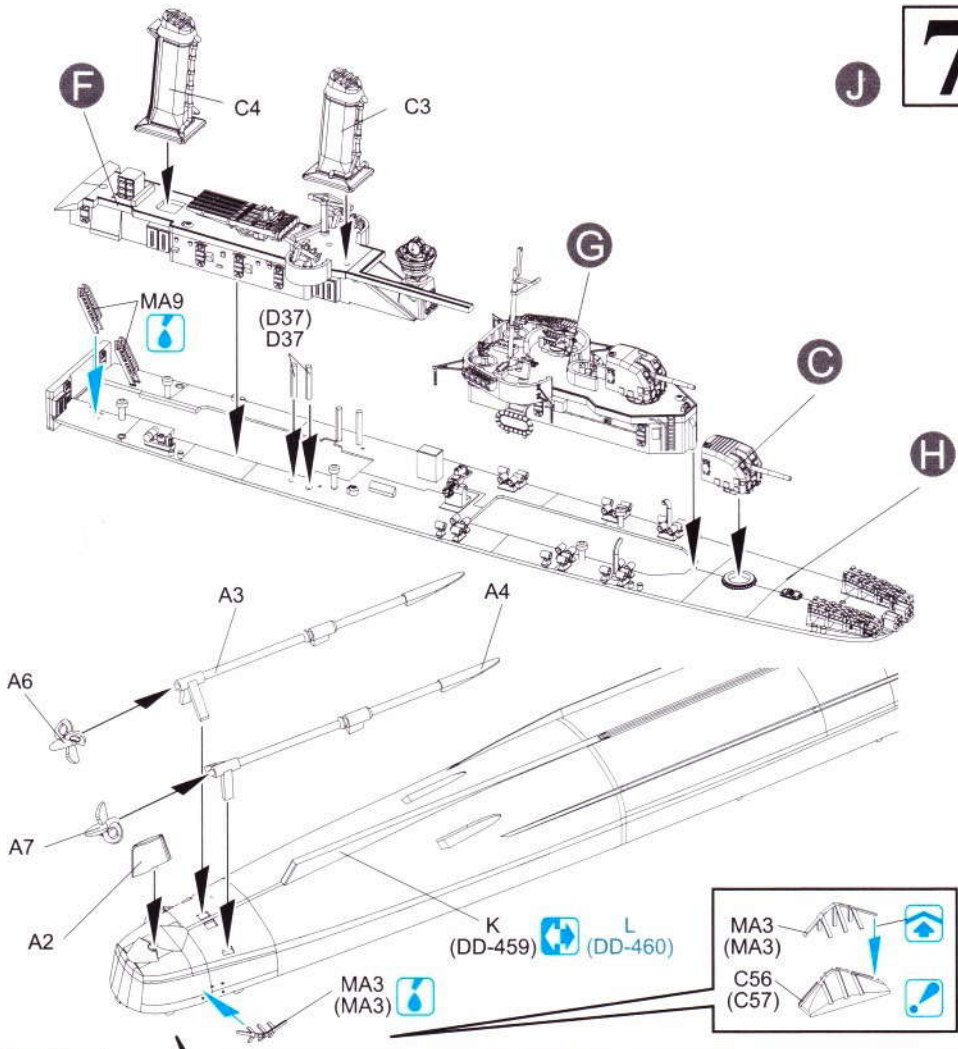

8

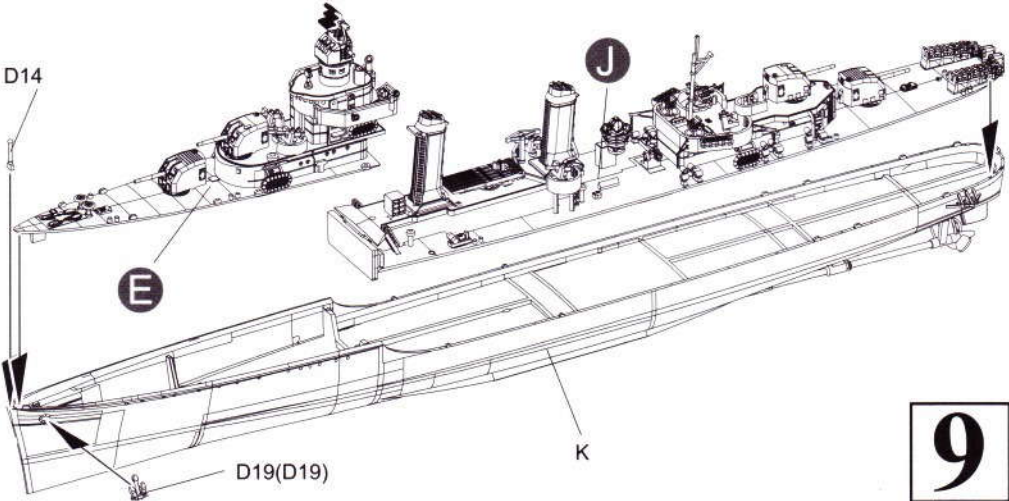
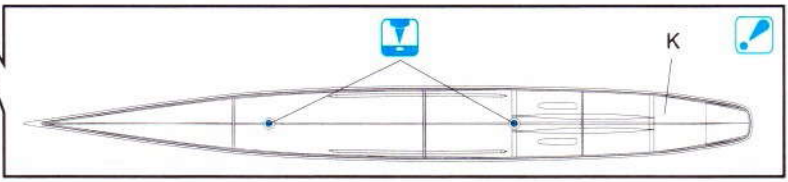

9

10

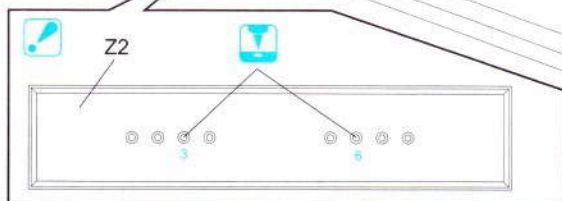
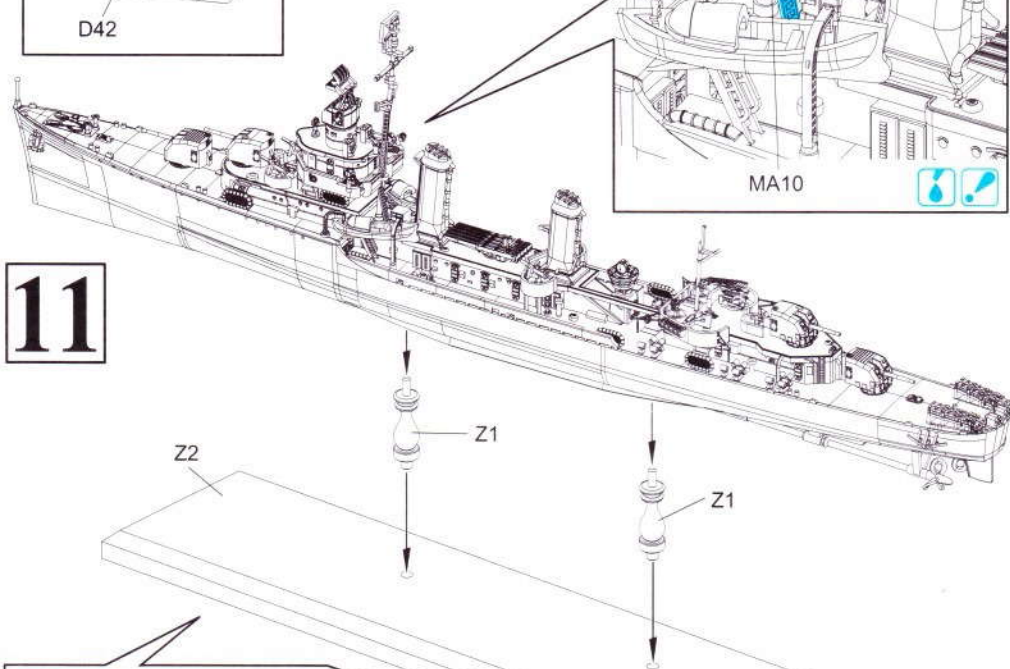
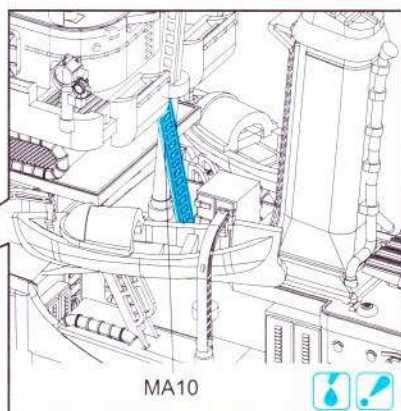
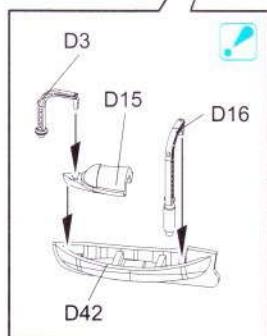
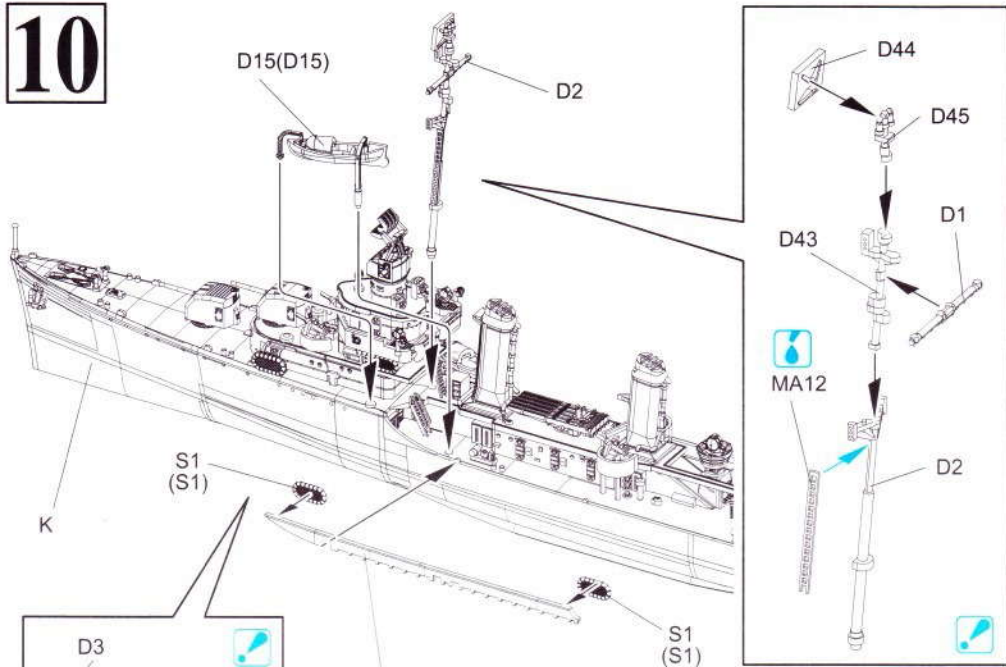

Painting & Markings

マーキング及び塗装図 Markierungen und Bemalung Decoration et Peinture

Marchio & Pittura 標貼及着色指示

U.S.S. Laffey DD-459

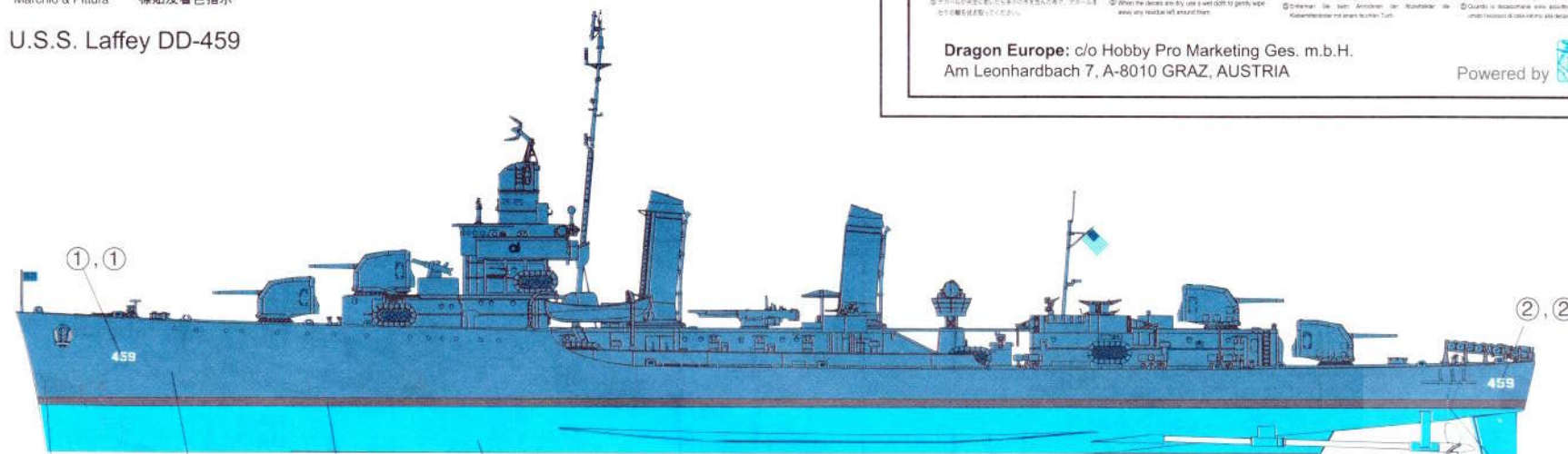

③, ③ 5-N NAVY BLUE H 54 14 1717
 FLAT BLACK H 12 33 1759
 HULL RED H 23 79 1593

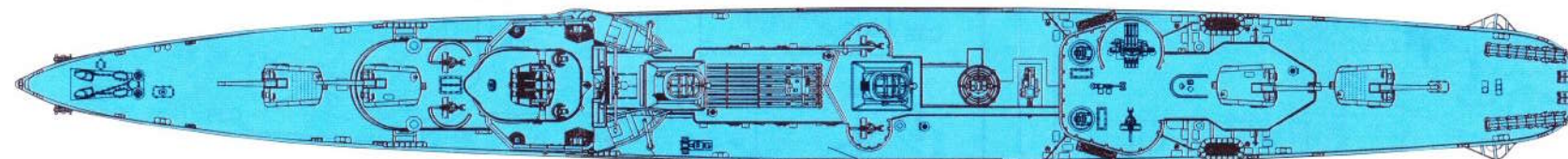

20-B DECK BLUE
 45% H 43 72 + 45% H 54 14 + 5% H 2 2 + 5% H 3 3

U.S.S. Woodworth DD-460

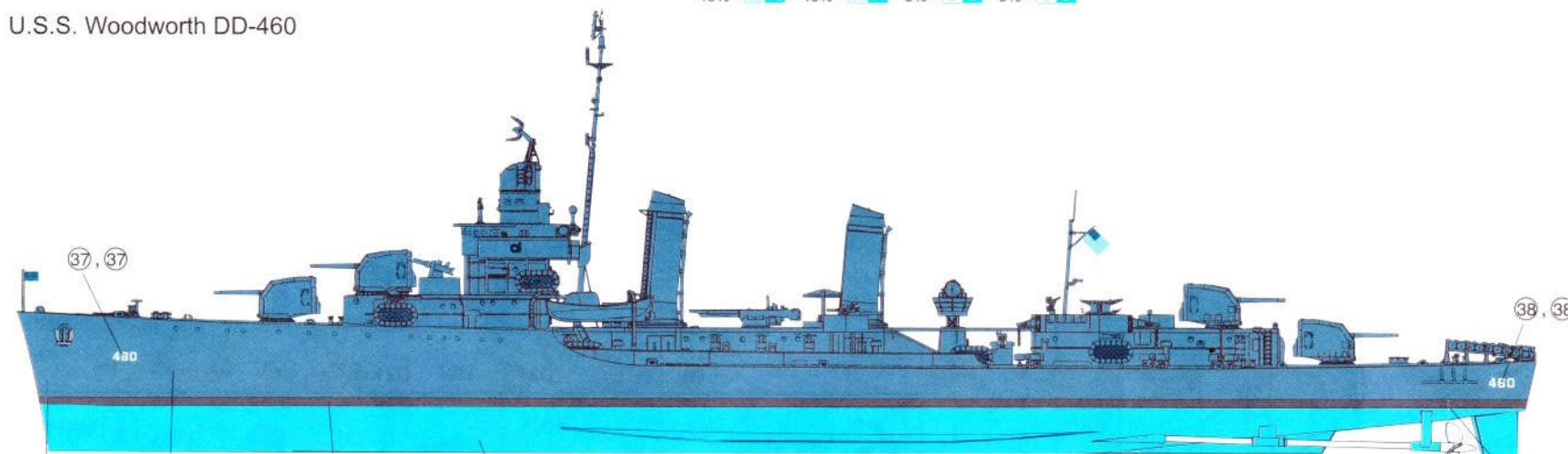

③, ③ 5-N NAVY BLUE H 54 14 1717
 FLAT BLACK H 12 33 1759
 HULL RED H 23 79 1593

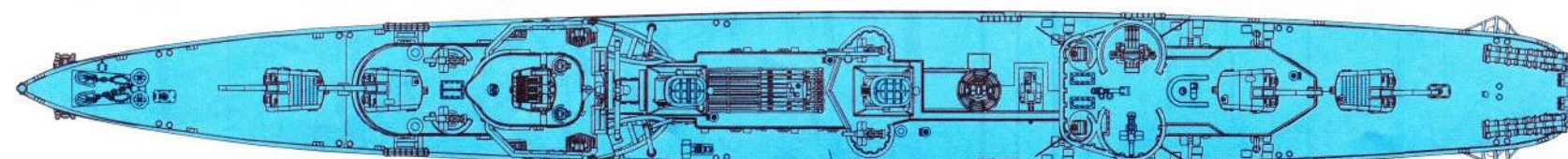

20-B DECK BLUE
 45% H 42 72 + 45% H 54 14 + 5% H 2 2 + 5% H 3 3

- 正しいデカール貼付けの方法
 ① 模型の表面をきれいに拭き取ります。
 ② デカールを貼る前に、デカールを貼る部分の紙を剥がして、デカールの裏面に貼る。
 ③ デカールを貼る前に、デカールの裏面に貼る。
 ④ デカールを貼る前に、デカールの裏面に貼る。
 ⑤ デカールを貼る前に、デカールの裏面に貼る。
- Correct Method for Applying Decals
 ① Clean the model surface with a wet cloth.
 ② Cut out each decal design from the decal sheet, and dip it in warm water for 30 seconds.
 ③ Use a fingertip to check if the decal is loose from the backing paper. If so, place it in the proper position on the model, and slide it off the backing paper onto the model.
 ④ Move the decal to the exact position with a wet fingertip, and spread out any excess water or air bubbles under the decal with a soft cotton swab.
 ⑤ When the decal dries, use a wet cotton swab to gently wipe away any excess water.
- Das Korrekte Aufbringen der Abziehbilder
 ① Überflache des Modells mit feuchtem Tuch reinigen.
 ② Jedes Motiv einzeln aus dem Folien-Abziehbilderschneideblatt ausschneiden und in warmes Wasser tauchen.
 ③ Mit dem Finger prüfen, ob sich das Motiv von der Trägerpapier gelöst hat. Wenn ja, so positionieren Sie es vorsichtig auf dem Modell.
 ④ Verschieben Sie das Motiv leicht mit feuchtem Fingerfinger auf die exakte Position. Mit einem weichen Baumwollwolle abwischen, um überschüssiges Wasser zu entfernen.
 ⑤ Wenn das Abziehbild getrocknet ist, verwenden Sie einen feuchten Wattebausch, um überschüssiges Wasser zu entfernen.
- Modo esatto per applicare le decalcomanie
 ① Pulire la superficie del modello con un panno umido.
 ② Ritagliare ciascun disegno del foglio decalcomanico e immergerlo in acqua calda per 30 secondi.
 ③ Controllare con un dito se il disegno si stacca dalla base di carta. Se è così, spostare nella giusta posizione sul modello, quindi sollevarlo dalla carta.
 ④ Spostare il disegno nella giusta posizione con un dito umido, quindi togliere l'acqua in eccesso con un batuffolo di cotone.
 ⑤ Quando le decalcomanie sono asciutte, togliere con un panno umido l'acqua in eccesso dalla superficie del modello.
- Comment appliquer les decalcomanies correctement
 ① Nettoyer la surface du modèle avec un chiffon humide.
 ② Découper chaque decalcomanie de la feuille de papier et la plonger dans l'eau chaude pendant vingt secondes.
 ③ Vérifier avec le bout du doigt si le dessin se détache de son support. Si oui, le positionner à l'endroit désiré sur le modèle et le soulever délicatement de son support.
 ④ Déplacer le dessin dans la juste position avec un doigt humide, puis éliminer l'excès d'eau avec un coton-tige.
 ⑤ Quand les decalcomanies sont sèches, éliminer l'excès d'eau de la surface du modèle avec un chiffon humide.
- 貼上デカールの正しい方法
 ① 模型表面を濡れた布で拭く。
 ② 各デカールデザインをデカールシートから切り取り、ぬるま湯に30秒間浸す。
 ③ 指先でデカールが紙から離れているかを確認する。離れている場合は、模型上の正しい位置に移動し、紙から慎重に剥がす。
 ④ 濡れた指先でデカールを正確な位置に移動させ、余剰の水や空気を綿棒で優しく拭き取る。
 ⑤ デカールが乾燥したら、濡れた綿棒で余剰の水を拭き取る。

Dragon Europe: c/o Hobby Pro Marketing Ges. m.b.H.
 Am Leonhardbach 7, A-8010 GRAZ, AUSTRIA

Powered by **DRAGON** Copyright © 2009
 7086-01

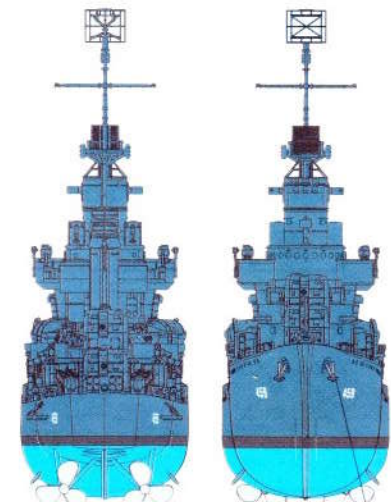

H 9 9
 H 12 28

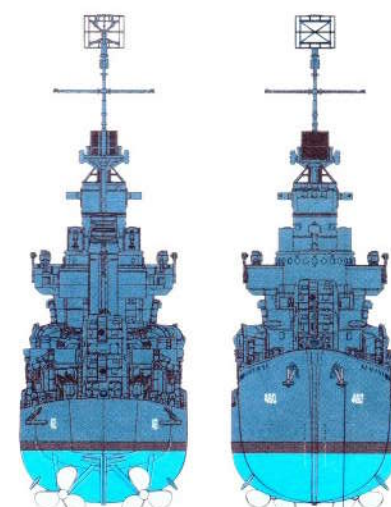

H 9 9
 H 12 28

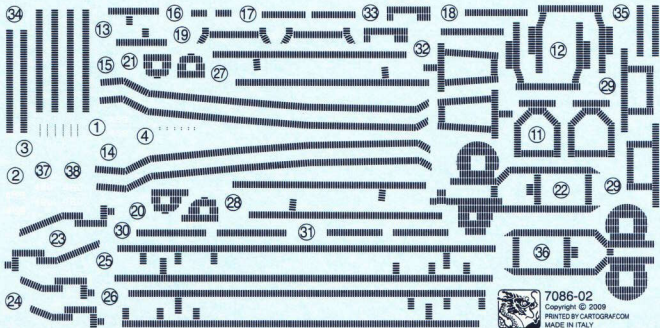

7086-02
Copyright © 2009
PRINTED BY CARTOGRAF.COM
MADE IN ITALY



1:700-02b
Copyright © 2009

XXXXXXXXXXXXXXXXXXXX

MA-7085

