

# FROG F.177 HEINKEL He 219 A-2 UHU

How to put your Frog model together / Méthode d'assemblage de votre modèle Frog / Wie stellt man Ihr Frogmodell zusammen / Con

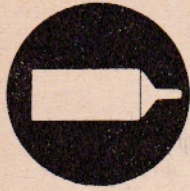

ement parts together.  
Coller les pièces ensemble.  
Teile zusammenkleben.  
Cementare de delen samen.  
Limma ihop delarna.  
Cementare le parti l'una con l'altra.  
Osat liimata yhteen.

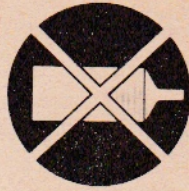

Do not cement together.  
Ne pas coller ensemble.  
Nicht zusammenkleben.  
Cementare niet samen.  
Limma inte ihop delarna.  
Non cementare le parti.  
Osia ei liimata yhteen.



Shape with a hot knife.  
Former au canif chaud.  
Mit einem heißen Messer formen.  
Vorm met een heet mes.  
Forma med varm kniv.  
Modellare con la lama di un coltello, riscaldata.  
Muovattaa kuumalle veitsellä.

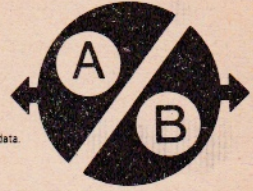

Choice of parts.  
Choix de pièces.  
Mitgelieferter Au.  
Keuze van bescl.  
Dessa delar med.  
Particolari a sce.  
Osien käyttö va.

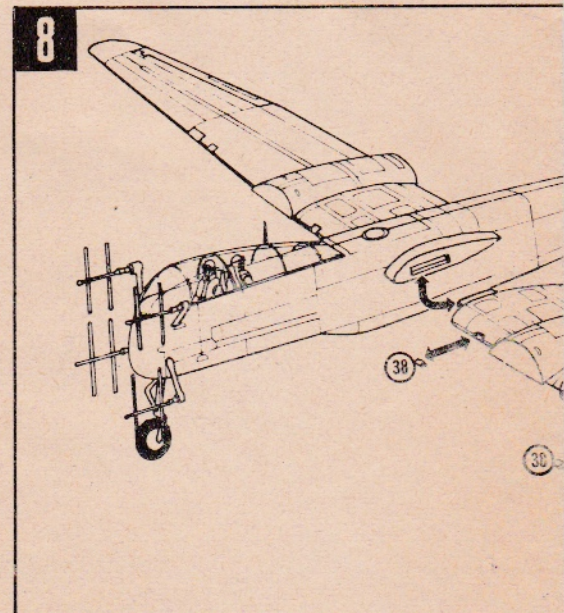
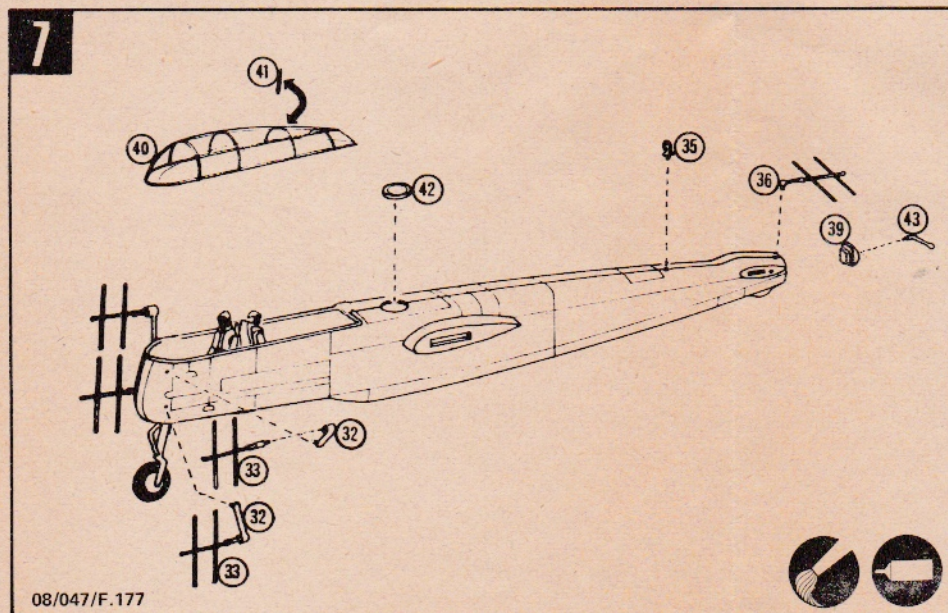
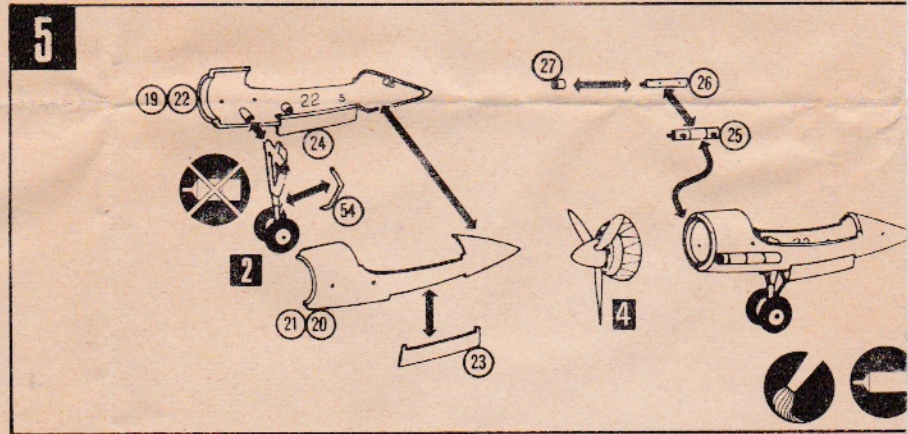
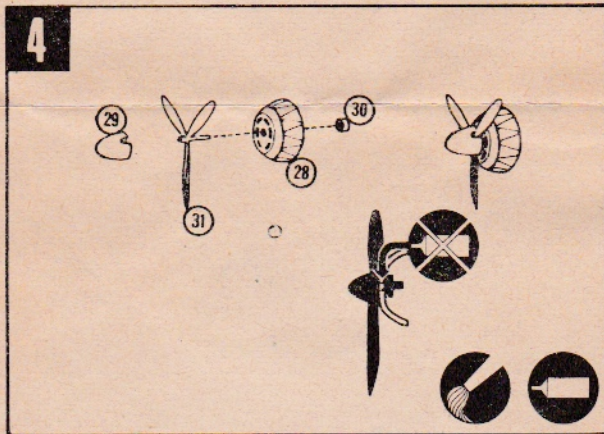
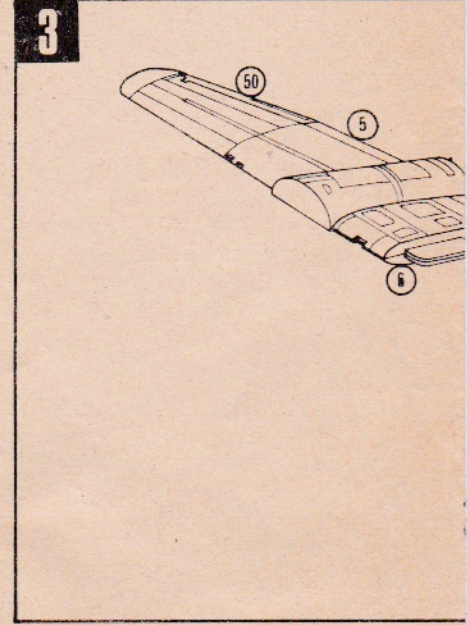
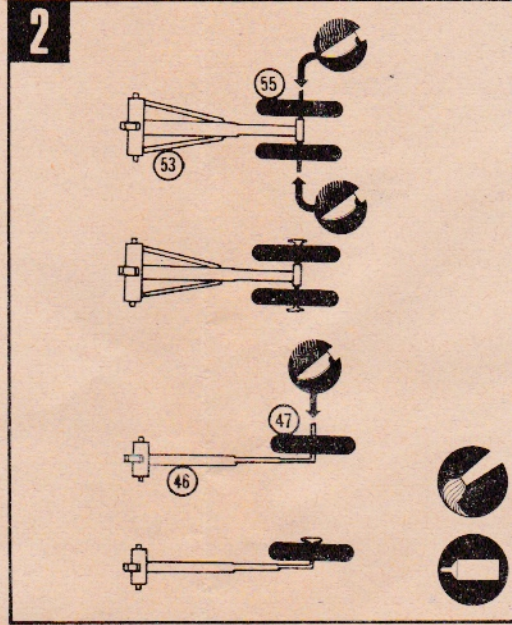
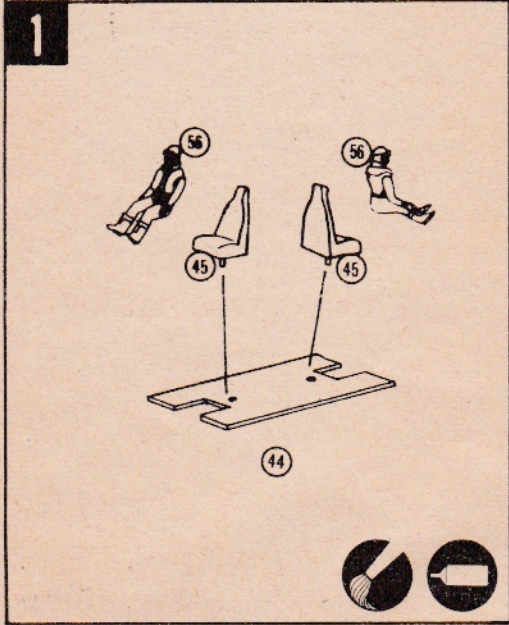

e montare il modello Frog /Hoe zet ik mijn Frogmodel in elkaar/Hur man sätter ihop Frog-modellen/Kootkaa Frog mallinne näin.

provided.  
 Furnies.  
 wahl an Teilen.  
 bare onderdelen.  
 glijer för valfri användning  
 envarsista.

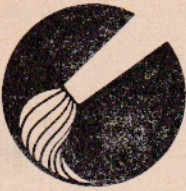

Paint parts before using.  
 Peindre les pieces avant l'emploi.  
 Die Teile sollen vor Benutzung bemalt werden.  
 De onderdelen voor het gebruik schilderen.  
 Mäla delarna före användningen.  
 Verniciare le parti prima di montarle.  
 Maalattaa osat ennen kokoamista.

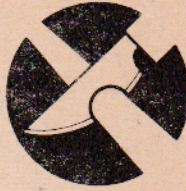

Cut with a sharp knife.  
 Couper avec un couteau tranchant.  
 Mit einem scharfen messe schneiden.  
 Snij met een scherp mes.  
 Skär med en skarp kniv.  
 Tagliare con un coltello affilato.  
 Leikata terävällä veitsellä.

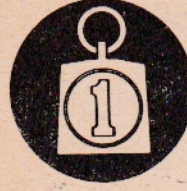

Insert small weight  
 Introduire le petit contrepoids.  
 Das kleine Gewicht soll eingesteckt werden.  
 Een klein gewichtje invoegen.  
 Stick in en liten tyngd.  
 Introduira il piccolo peso  
 Lisätkää pieni paino.

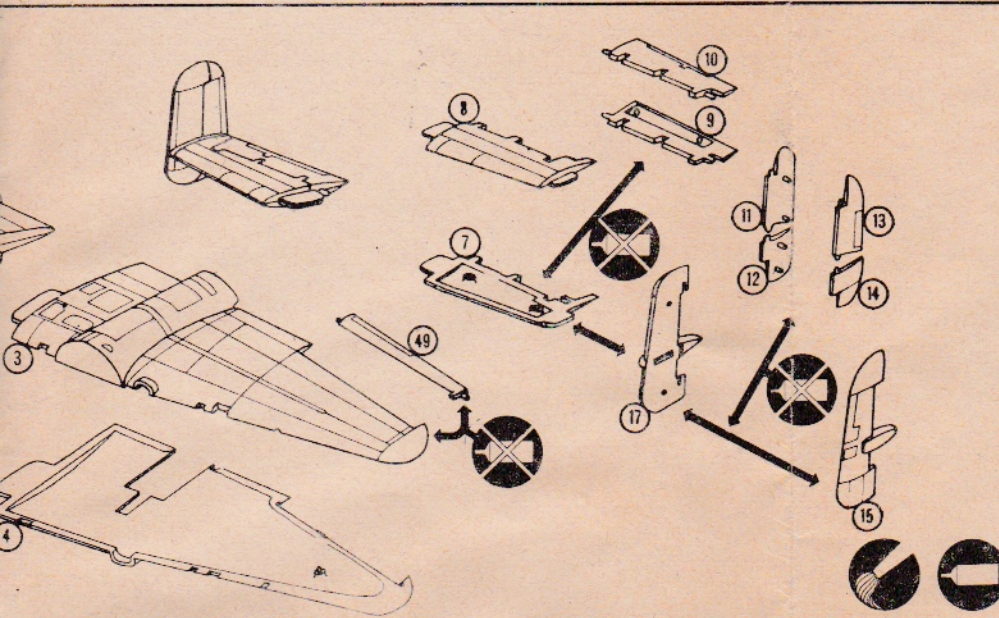

Name and Number of Kit.....  
 No. of Part.....  
**PLEASE USE BLOCK LETTERS**  
 Name.....  
 Address.....

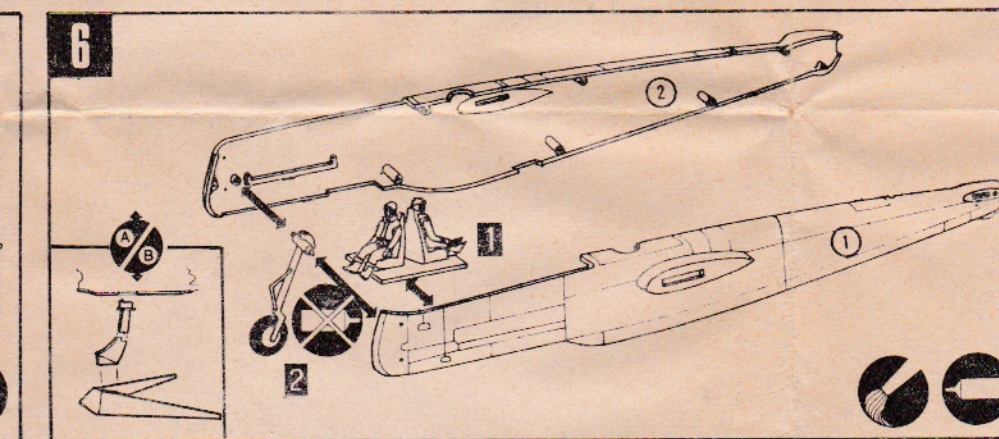

Every precaution has been taken to ensure that your kit will reach you complete. If however you find any part is faulty or missing please fill in the details opposite in block letters and return the slip to:

**Rovex Triang Limited,  
 Service Department,  
 Westwood, Margate,  
 Kent, England.**

Please give the Number of the Part shown in the exploded assembly diagram in this instruction leaflet.

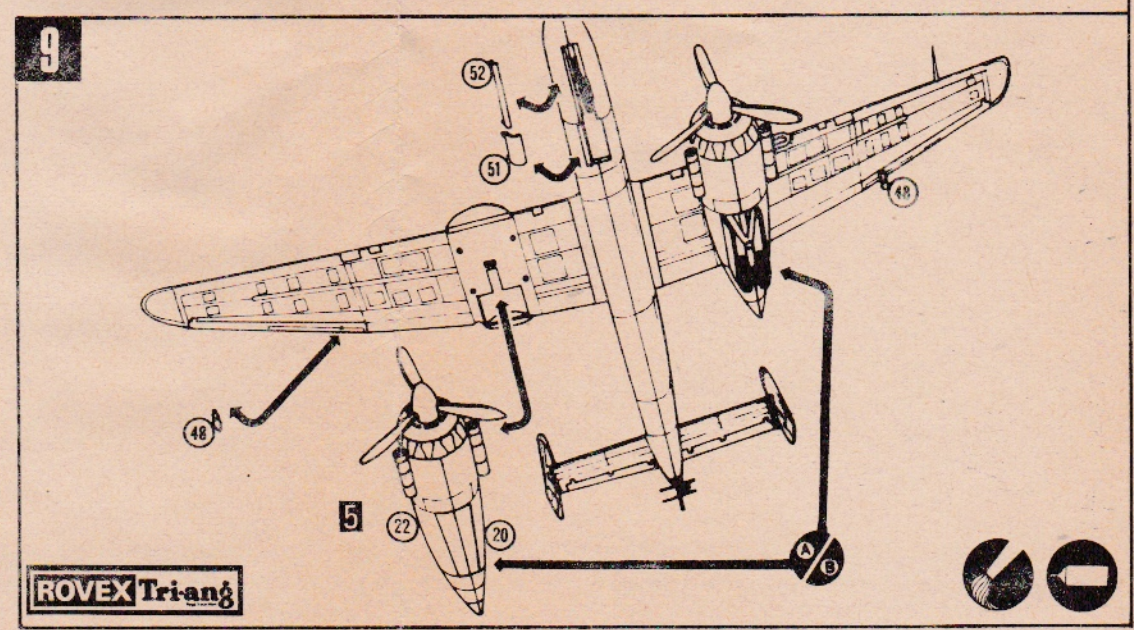
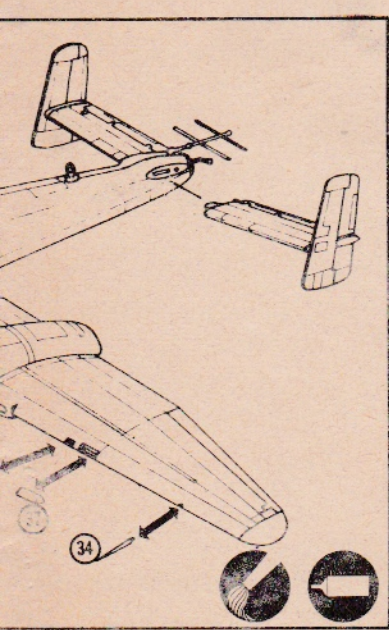

**ROVEX Triang**

# FROG

## Heinkel He 219

The He 219 was a twin-engine night fighter with an exceptional performance. Unfortunately delays in production caused by the incessant day and night bombing of Germany prevented it from becoming a serious threat to Allied bombers. However, those He 219's that did reach service units proved highly effective and one night fighter ace, Major Braub, shot down five bombers in one sortie. The Heinkel He 219 was one of the few machines fast enough to catch the famous Mosquito, and its lethal armament proved a menace to the unarmed Mosquito which relied entirely on its speed to out-distance any pursuer. By 1944 the standard camouflage schemes of the German Air Force were being replaced by a bewildering collection of non-standard finishes depending on the speed with which the aircraft were pressed into service. Some went into action with crosses hurriedly applied over the factory primer. He 219's were painted in a variety of schemes including all-black aircraft, light grey overall with dark grey mottle, splinter pattern wings with mottle finish to the fuselage and some aircraft were painted with large areas of black and white, possibly to break up the shape and so avoid recognition.

## KIT FEATURES

This 1/72nd scale model kit contains 93 parts including pilot and radar operator, movable propellers, wheels and control surfaces, plus a retractable undercarriage. A full set of markings as illustrated are included in the kit, all in authentic

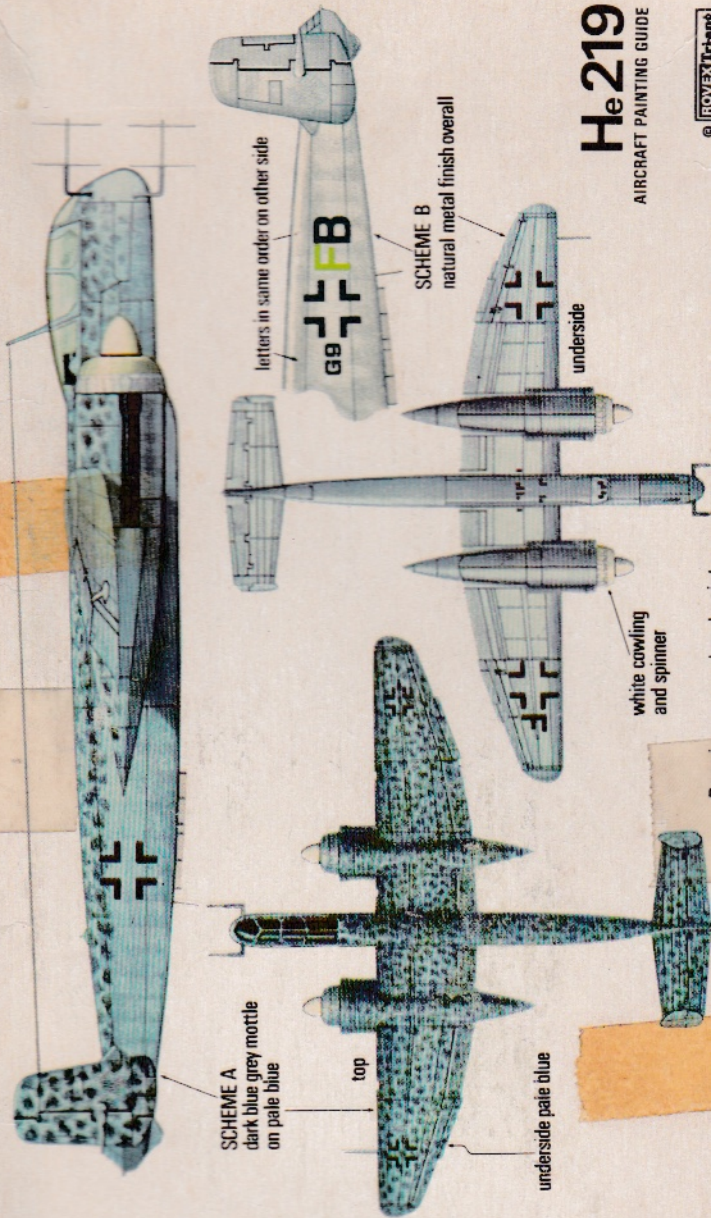

# He 219

AIRCRAFT PAINTING GUIDE