



FOKKER D-XXI

MODEL KIT / MODELLE REDUIT / MODELL BAUSATZ
1/72 ÖLÇEK / SCALE / MASSTAB / ECHELLE

Fokker D-XXI, aslında Hollanda Doğu Antiller Hava Kuvetlerinde görev yapmak için geliştirilmiş, sabit iniş takımlı, alttan kanatlı bir avcı uçağı idi. Bu siparişin iptal edilmesinden sonra Hollanda Hava Kuvetleri için yaklaşık 36 adetten başka bu uçaklardan Finlandiya ve Danimarka'da da üretildi. Fokker D-XXI savaş sırasında, Hollanda, Finlandiya ve Danimarka'daki çarpışmalarda görev yaptı.

TEKNİK ÖZELLİKLERİ:

Motor : 1x Bristol Mercury VIII	Tam Yüklü Ağırlık: 2,050 kg.
Güçü : 730 hp.	Maksimum Sürat: 460 km/s
Kanat Genişliği : 11,00 mt.	Uçuş Tavanı : 11,000 mt.
Gövde Boyu : 8,20 mt.	Uçuş Menzili : 950 km.
Yükseklik : 2,95 mt.	Silahları : 4 x 7,9 mm. makinalı tüfek

The Fokker D-XXI was fixed landing gear, low winged fighter originally developed for service with the Dutch East Indies Air Force. This order was canceled and some thirty-six aircraft were then built for the Dutch Air Force. The aircraft was also built in Finland and Denmark. Fokker D-XXI's saw combat in Holland, Denmark and Finland.

SPECIFICATION:

Engine : 1x Bristol Mercury VIII	Loaded Weight : 4,519 lb.
Max. Thrust : 730 hp.	Max. Speed : 286 mph.
Wing Span : 36 ft. 1 inch	Ceiling : 36,090 ft
Length : 26 ft. 10 inch	Range : 590 mls.
Height : 9 ft. 8 inch	Armament : 4 x 7,9 mm. Machine guns

Die Fokker D-XXI war ein Tiefdecker-Kampfflugzeug mit festem Fahrgestell das für den Einsatz in der niederländischen Luftwaffe in Ostindien entwickelt wurde. Dieser Auftrag wurde storniert und so wurden nur 36 Flugzeuge für die niederländische Luftwaffe gebaut. Dieses Flugzeug wurde auch in Finnland und Dänemark gefertigt. Fokker D-XXI kämpften in Holland, Dänemark und Finnland.

TECHNISCHE DATEN:

Triebwerk : 1x Bristol Mercury VIII	Abfulggewicht : 2,050 kg.
Startschub : 730 hp.	Höchstgeschwindigkeit: 460 km/s
Spannweite : 11,00 mt.	Dienstgipfelhöhe : 11,000 mt.
Länge : 8,20 mt.	Reichweite : 950 km.
Höhe : 2,95 mt.	Bewaffnung : 4 x 7,9 mm. Machine Kanonen

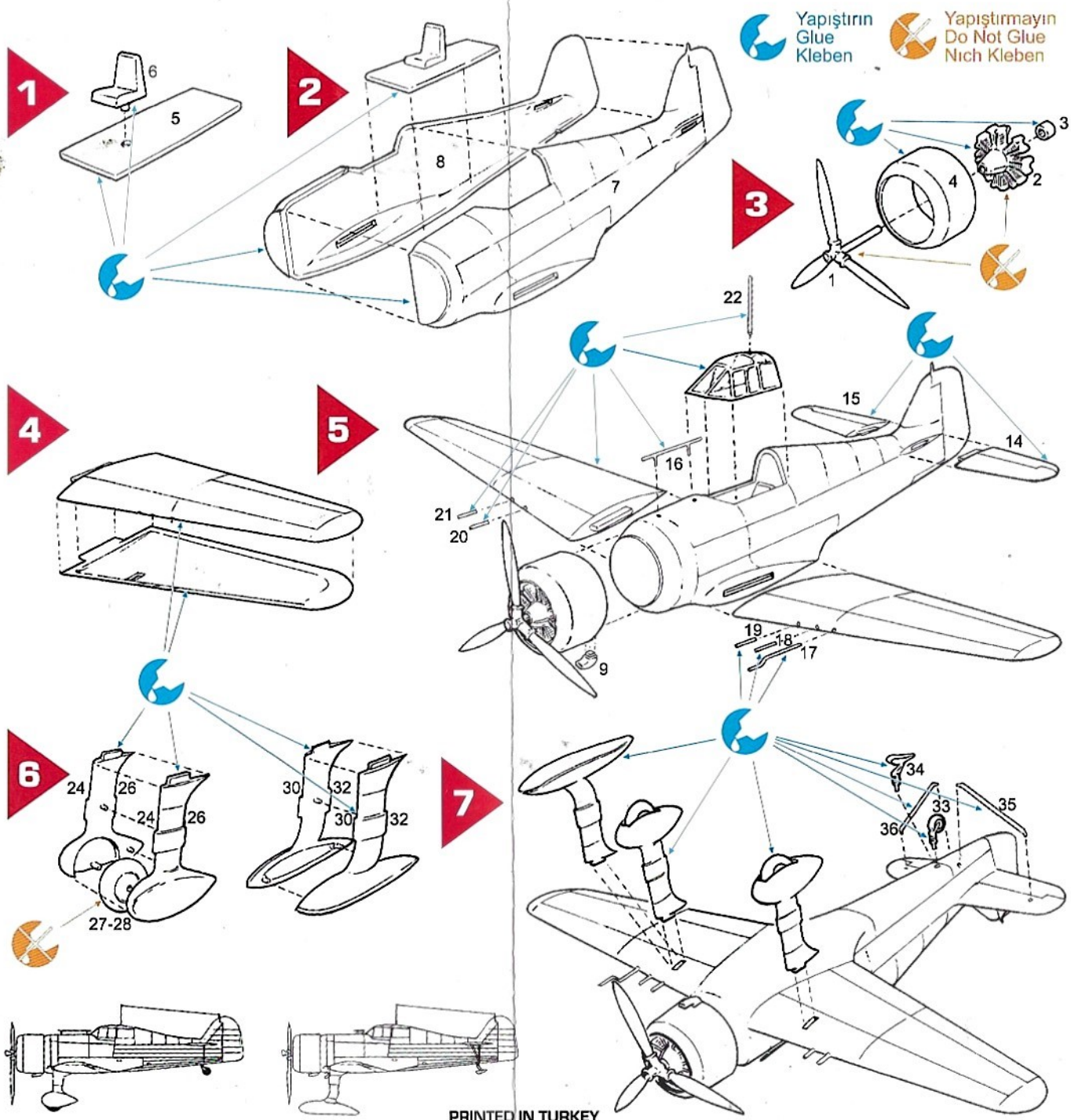

Yapıştırın
Glue
Kleben





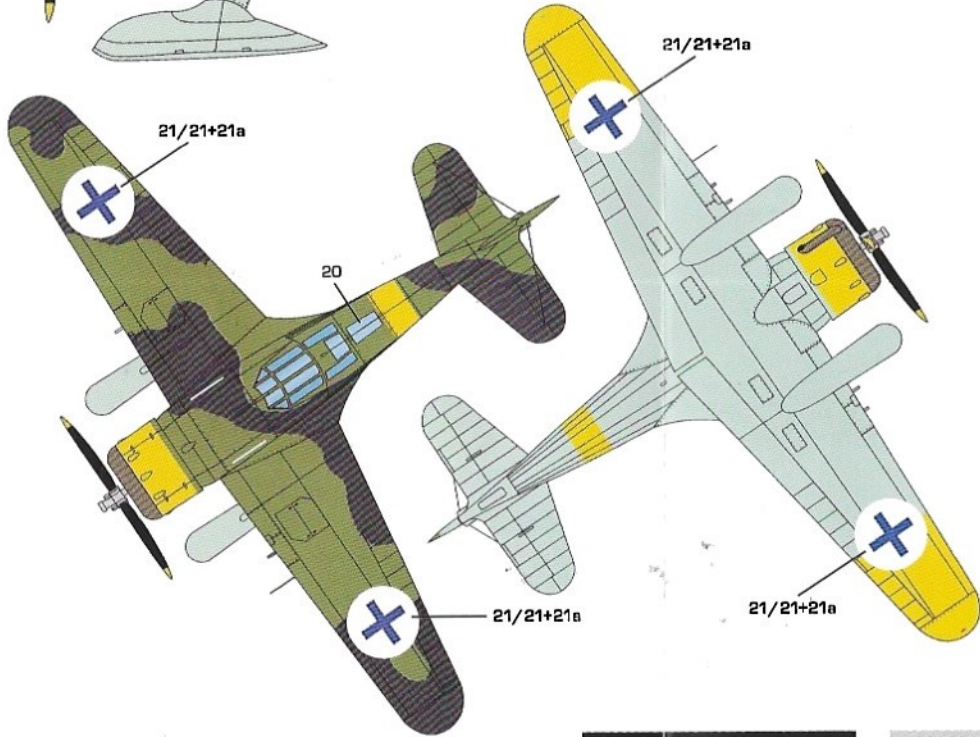
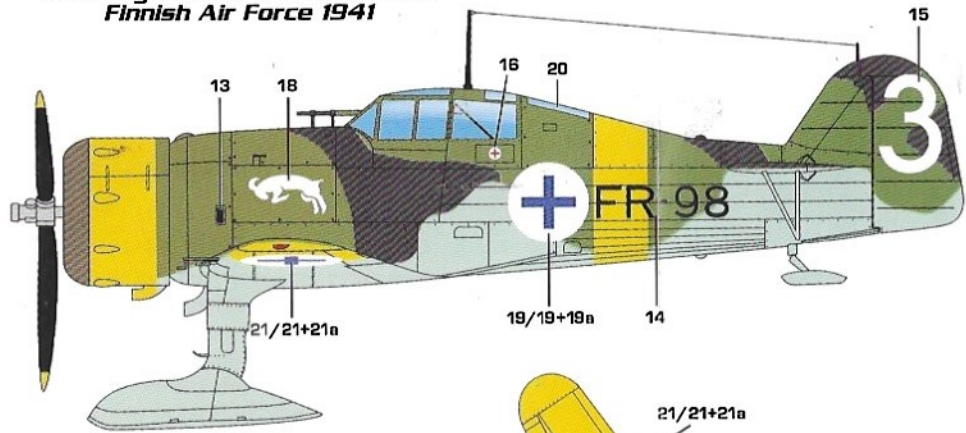

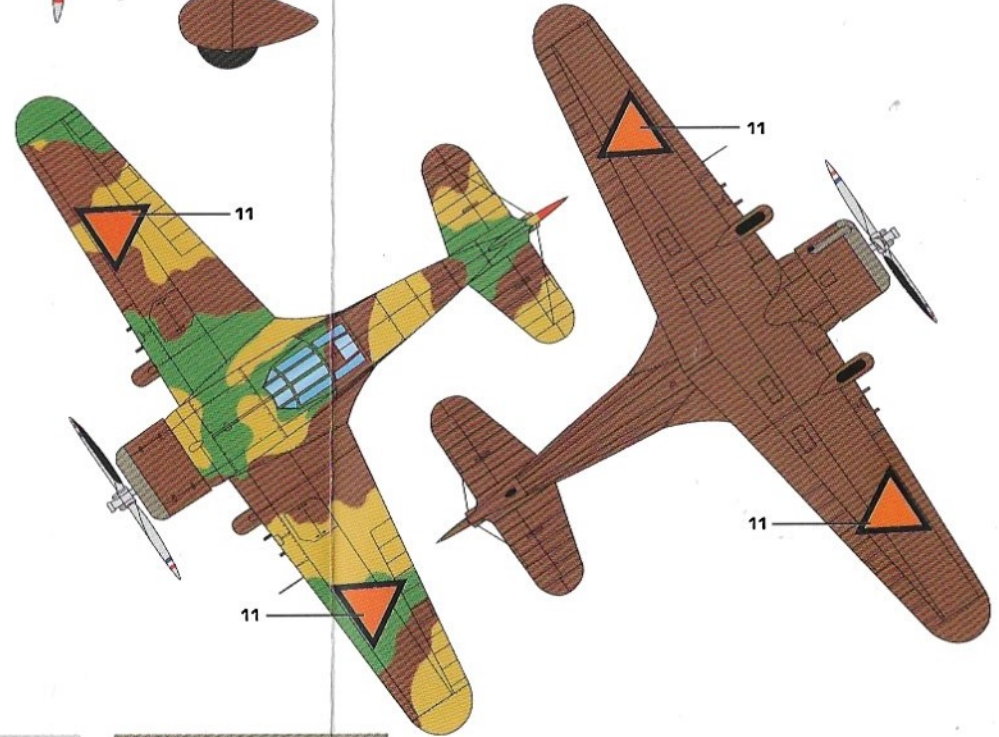
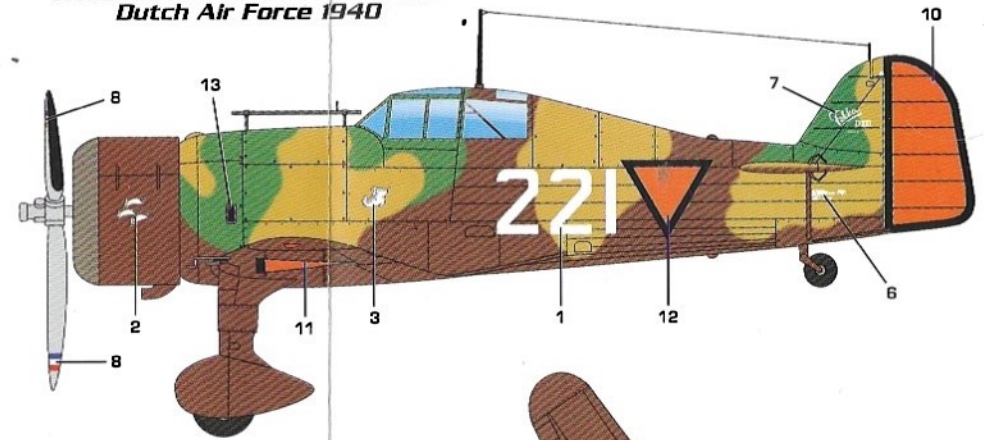

Yapıştırmayın
Do Not Glue
Nicht Kleben





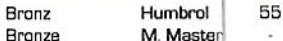

Fokker D-XXI
Finlandiya Hava Kuvvetleri 1941
Finnish Air Force 1941



Fokker D-XXI
Hollanda Hava Kuvvetleri 1940
Dutch Air Force 1940



			
Mat Siyah Matt Black Mattschwarz FS 37038	Humbrol 33 M. Master 1749 Gunze S. H12 Xtra Color X012	Gümüş Silver Silber FS 17178	Humbrol 011 M. Master 2714 Gunze S. H8 Xtra Color X501
			
Bronz Bronze	Humbrol 55 M. Master Gunze S. Revell 95	Kızıl Kahve Red Brown	Humbrol 160 Model Master Gunze Sangyo Xtra Color

													
Satin Siyah Satin Black Satin Schwarz FS 27038	Humbrol 85 Model Master 4700 Gunze Sangyo H2 Xtra Color X12	Zeytin Yeşili Olive Green Olivgrün FS 34096	Humbrol 114 Model Master 1710 Gunze Sangyo H36 Xtra Color X20	Açık Gri Light Grey Hellgrau FS 36440	Humbrol 129 Model Master 1730 Gunze Sangyo H51 Xtra Color X137	Sarın Yellow Gelb FS 13538	Humbrol 69 Model Master 1790 Gunze Sangyo H329 Xtra Color X106	Kum Sand Sand FS 33434	Humbrol 94 Model Master Gunze Sangyo H459 Xtra Color x209	Kızıl Kahve Red Brown Rot Braun FS 30109	Humbrol 160 Model Master Gunze Sangyo Xtra Color	Yeşil Green Grün FS 34138	Humbrol 88 Model Master Gunze Sangyo Poly S PF 51

PM
MODEL
PM-209

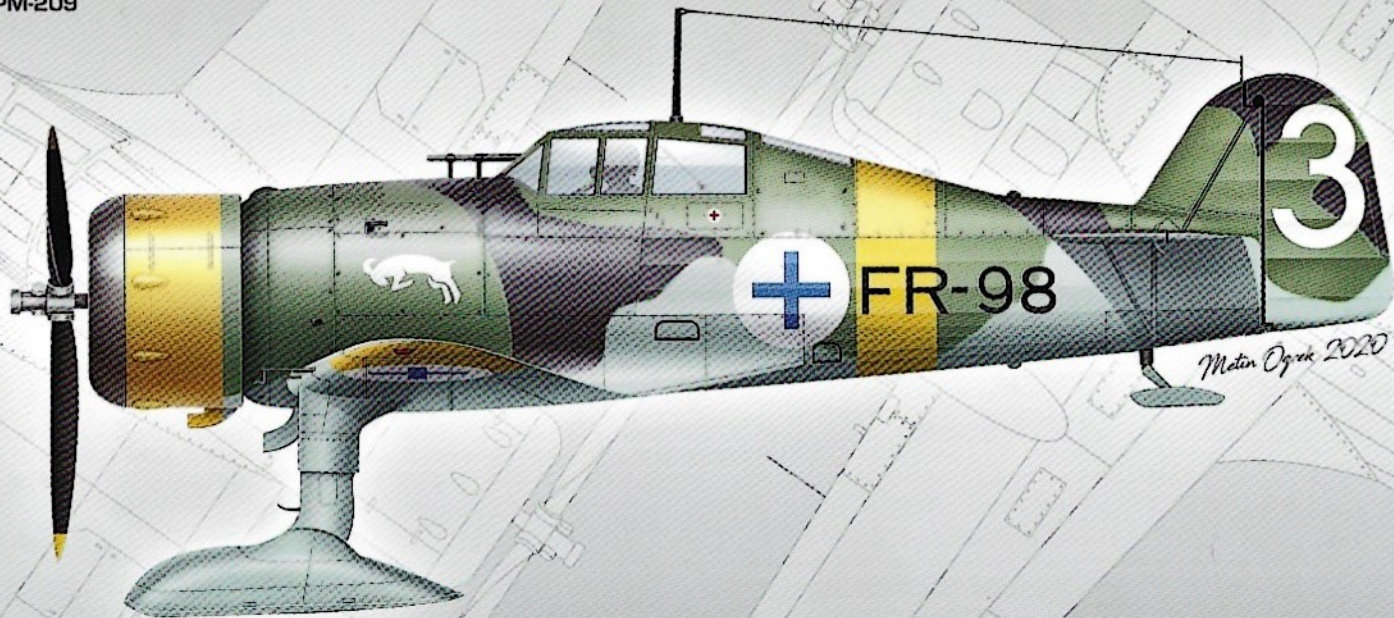

Matin Ogvik 2020

FOKKER D-XXI