



CTAMODELS.COM

Grumman F7F Tigercat

F7F-2N, 80323, 23, VF(N)-52, USS Antietam, April 1945.



48 Undercarriage Door

No.56
SCALE 1:72

The same Aircraft. In different sources, number "23" on the tail is depicted in different ways. Make a choice of option.

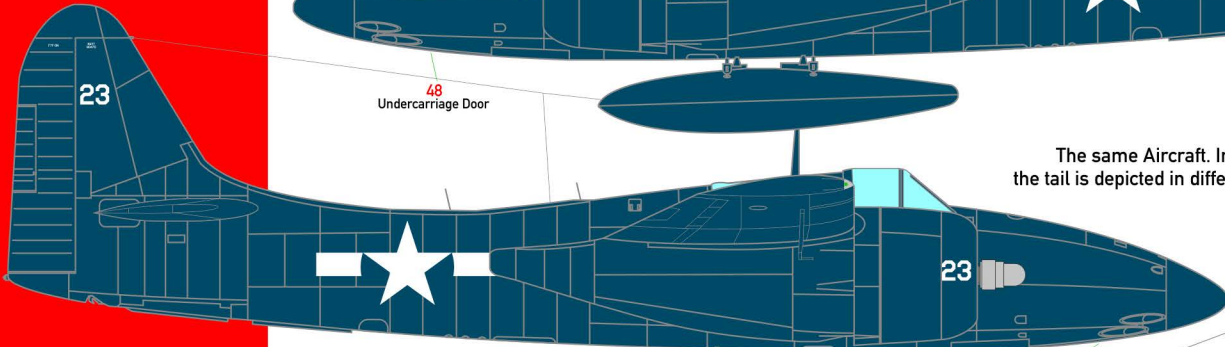

48 Undercarriage Door

F7F-3N, 80470, Z57 VMF(N)-534, USS Shangri-La, February 1946.

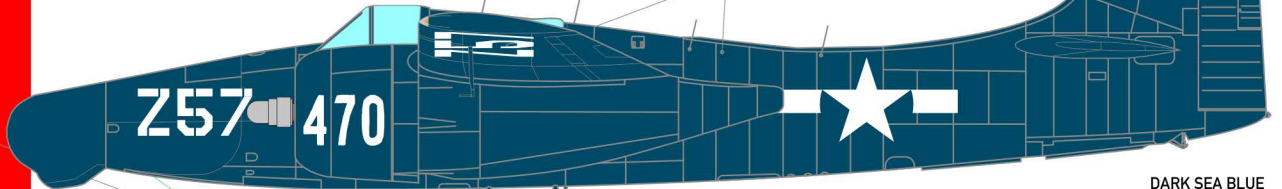

47 Undercarriage Door

DARK SEA BLUE

F7F-3N, 80569, N4, VMF(N)-533, USS Tarawa, December 1946.

Use photos and /or your kit's manual for reference.

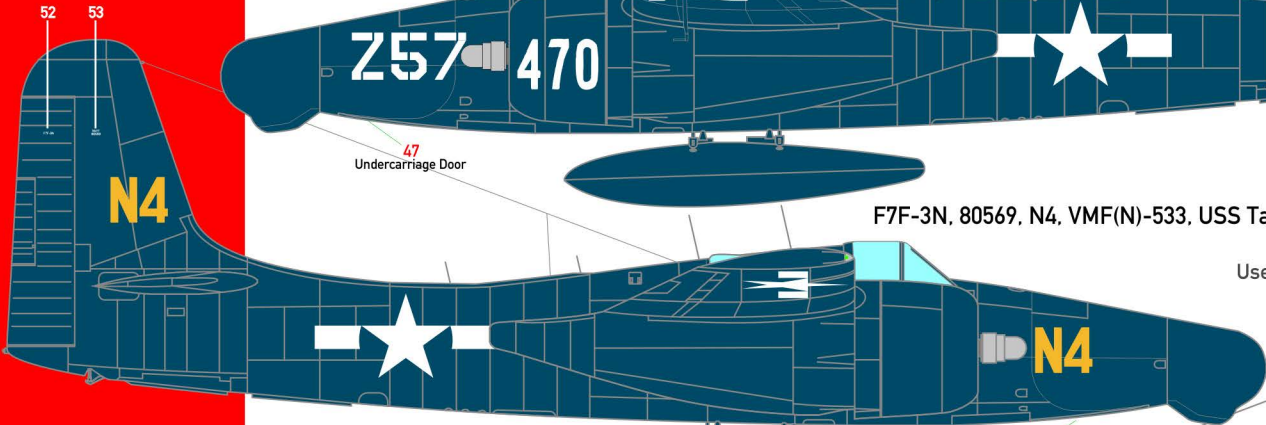

49 Undercarriage Door

F7F-4N, 80613, LA/62, VCN-2, USS Kearsarge, September 1947.

3/12/15/30 57 Under Cockpit, both side

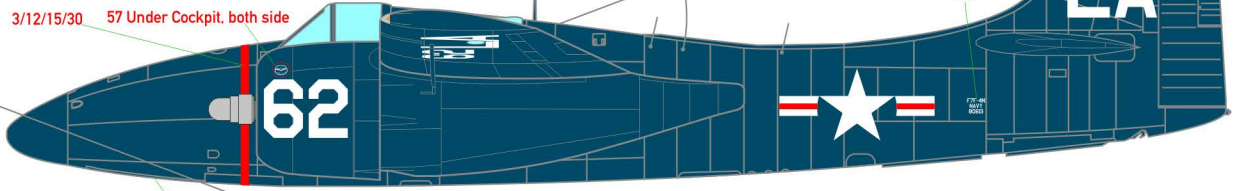

45 Undercarriage Door

F7F-4N, 80617, PA/32, VCN-1, USS Valley Forge, November 1947.

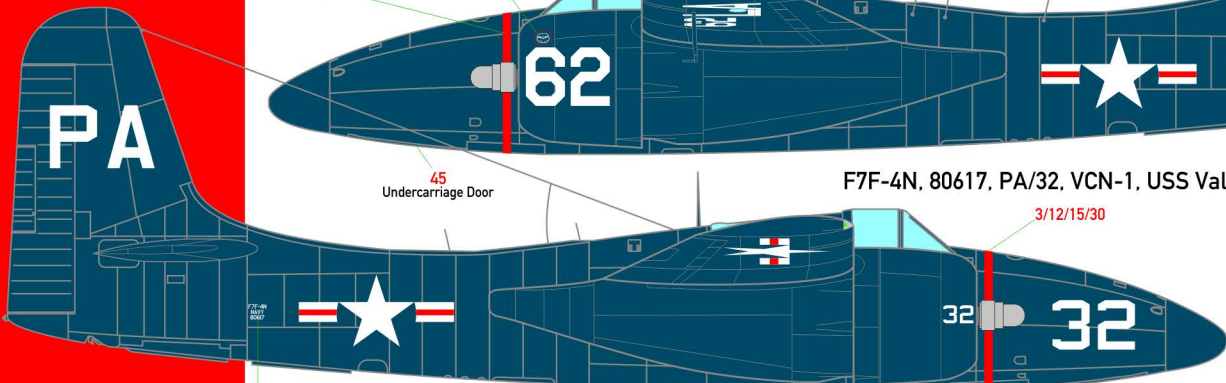

46 Undercarriage Door



"Cut then Add" SP © 2023
All Rights Reserved.

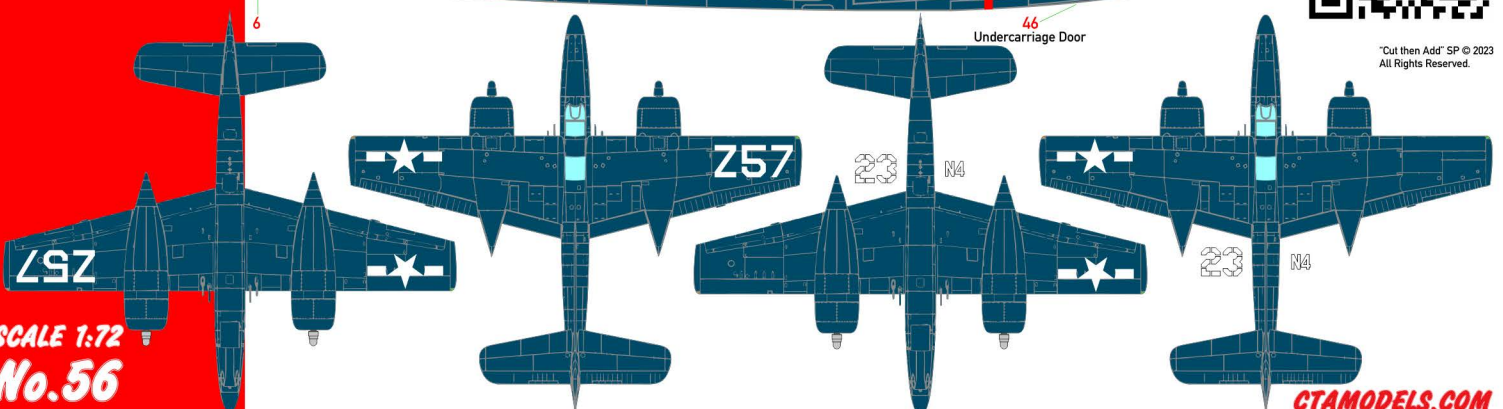

SCALE 1:72
No.56

CTAMODELS.COM

Grumman F7F Tigercat

Technical Data Stencils



No.56
SCALE 1:72

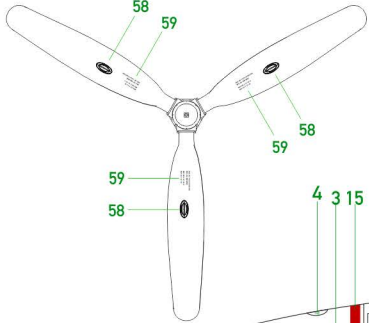
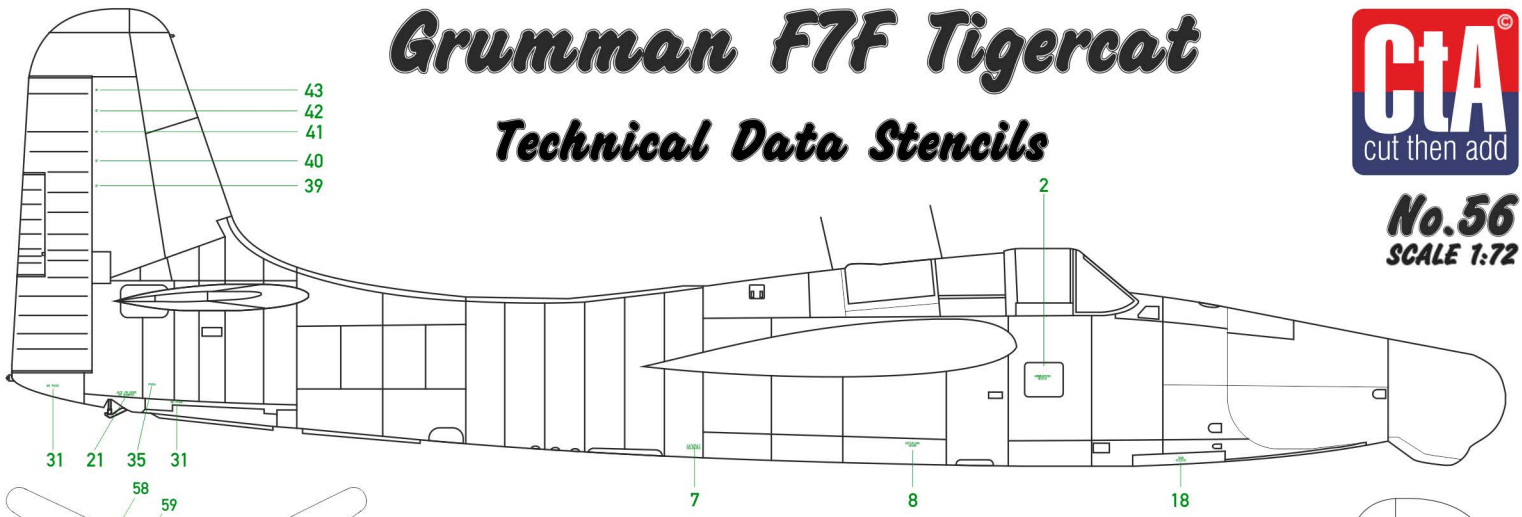

Use photos and /or your kit's manual for reference.

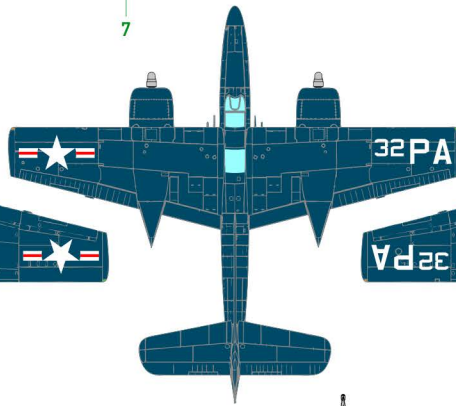
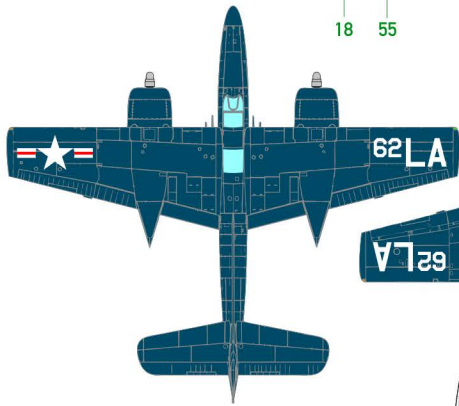
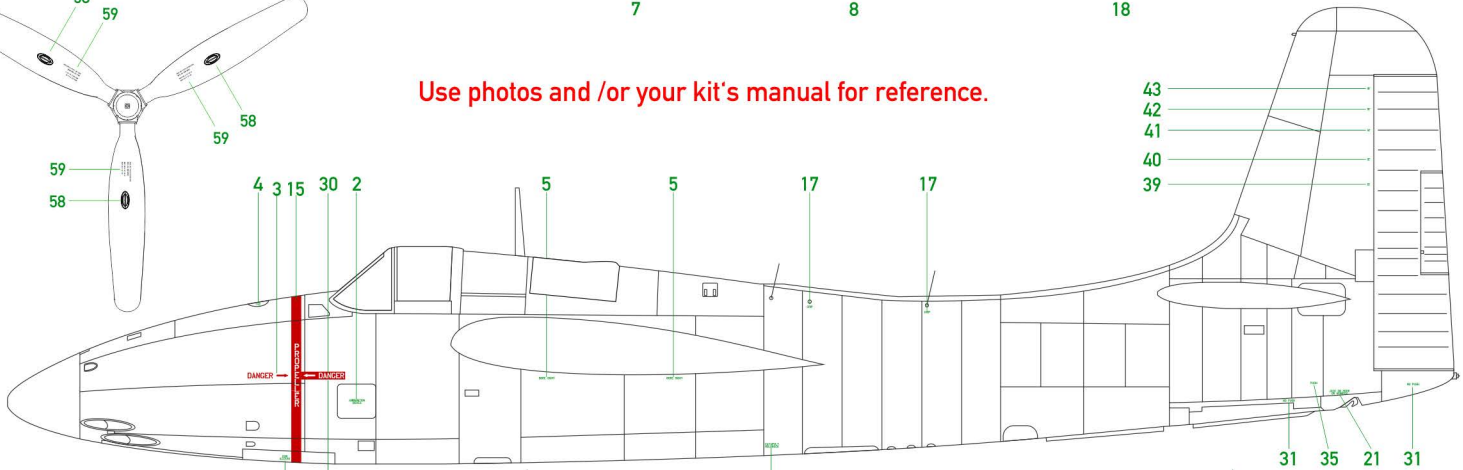

DARK SEA BLUE

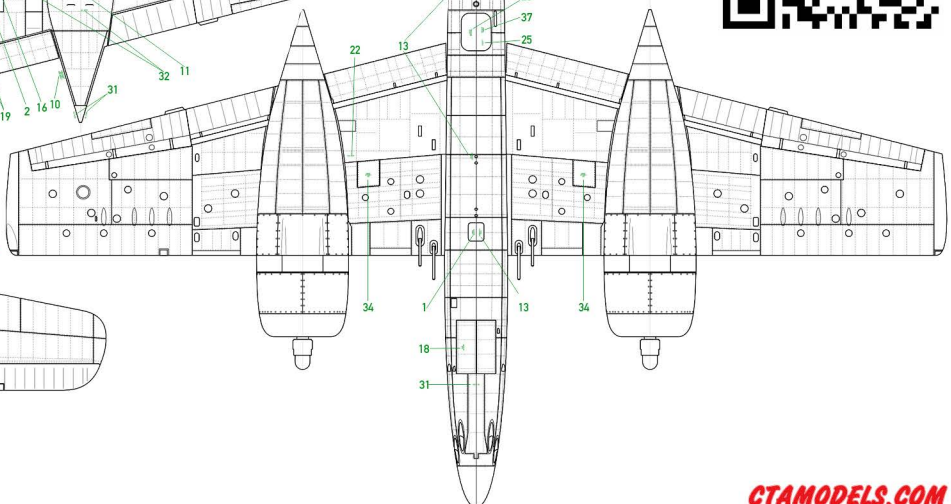
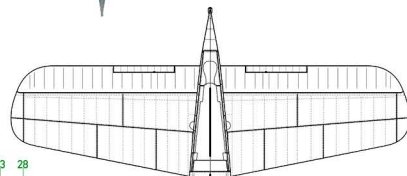
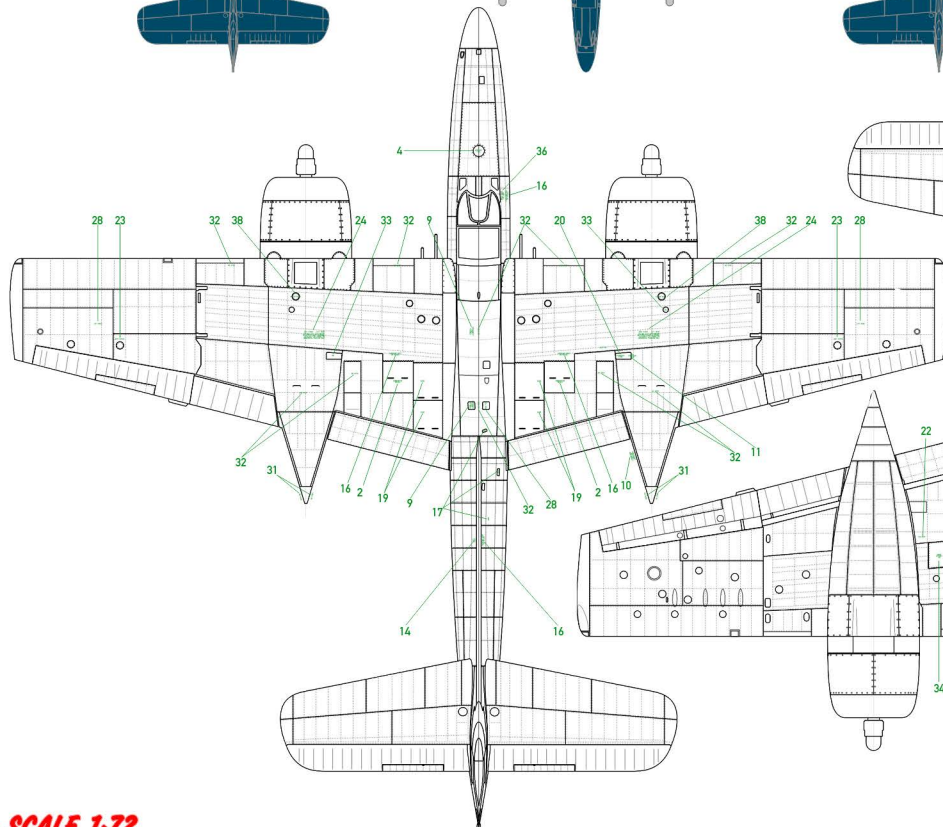

SCALE 1:72
No.56

CTAMODELS.COM