

# FROGM<sup>®</sup> 1 OR 3 LYSANDER

How to put your model together.  
 Mode d'assemblage de votre modèle.  
 Anweisungen für den Zusammenbau des Modells.  
 Methode voor het in elkaar zetten van Uw model.  
 Så här sätter Du ihop modellen.  
 Per montare il vostro modello.

Symbols used in assembly diagrams / Symboles employés sur les diagrammes d'assemblage / In den Zusammenstellungsskizzen verwendete Zeichen.  
 Tekens die in de monteringsdiagrammen gebruikt worden / Teckenförklaring till sammanfogningsdiagram / Simboli usati nello schema de montaggio.



Cement parts together.  
 Coller les pièces ensemble.  
 Teile zusammenkleben.  
 Cementeer de delen samen.  
 Limma ihop delarna.  
 Cementare le parti l'una con l'altra.



Do not cement together.  
 Ne pas coller ensemble.  
 Nicht zusammenkleben.  
 Cementeer niet samen.  
 Limma inte ihop delarna.  
 Non cementare le parti.

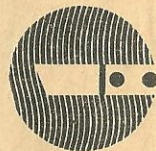

Shape with hot knife.  
 Former au canif chaud.  
 Mit einem heißen Messer formen.  
 Vorm met een heet mes.  
 Forma med varm kniv.  
 Modellare con la lama di un coltello, riscaldata.



Choice of parts provided.  
 Choix de pièces fournies.  
 Mitgelieferte Auswahl an Teilen.  
 Keuze van beschikbare onderdelen.  
 Dessa delar medföljer för valfri användning.  
 Particolari a scelta.

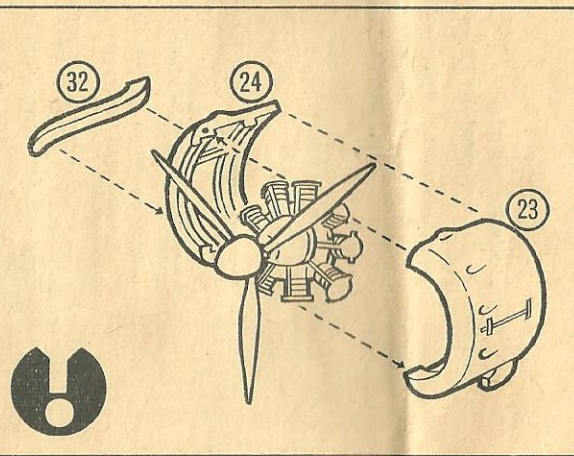
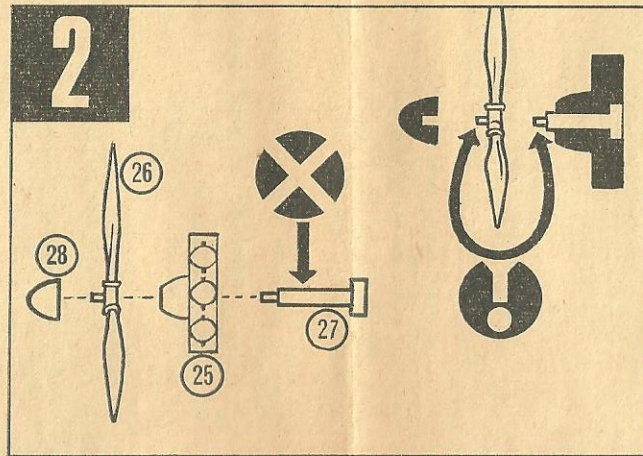
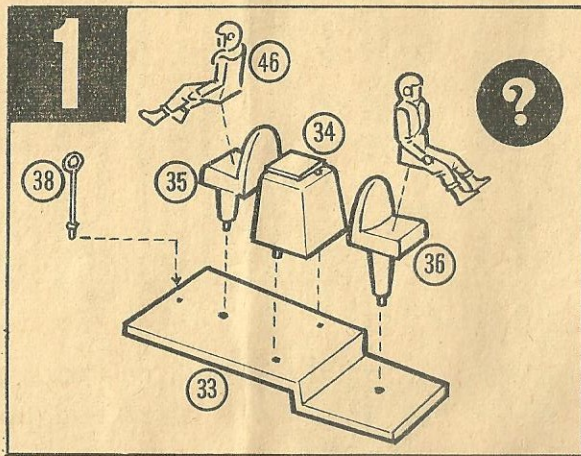

3

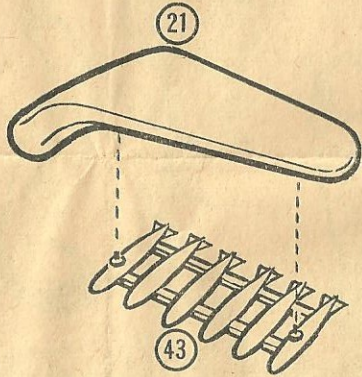

4

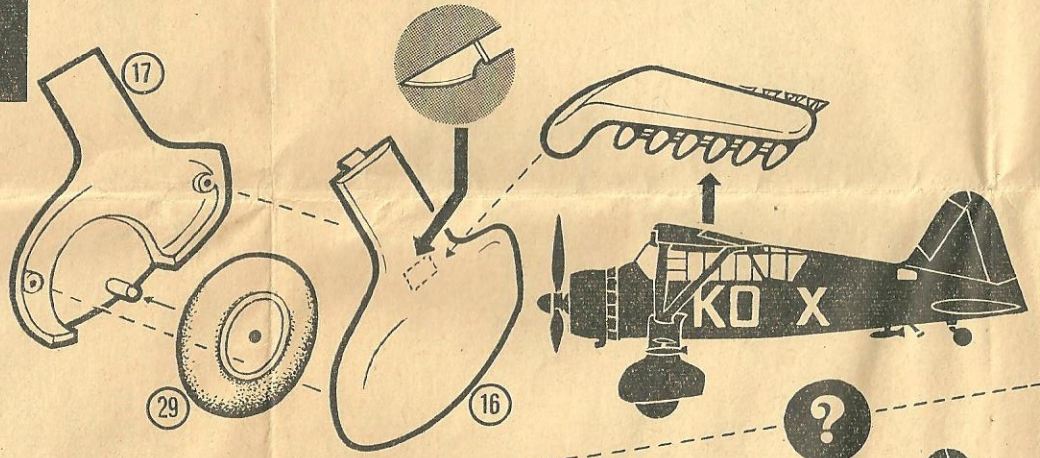

6

8

5

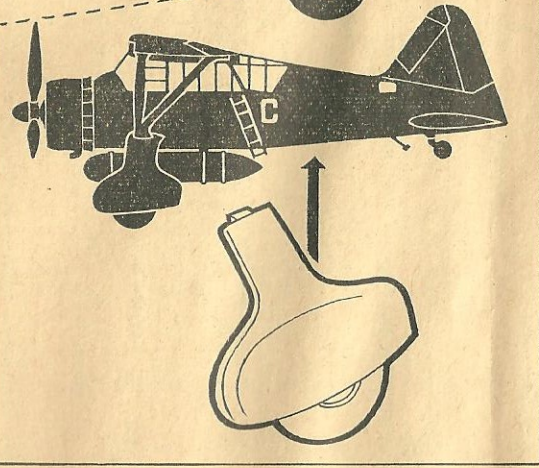
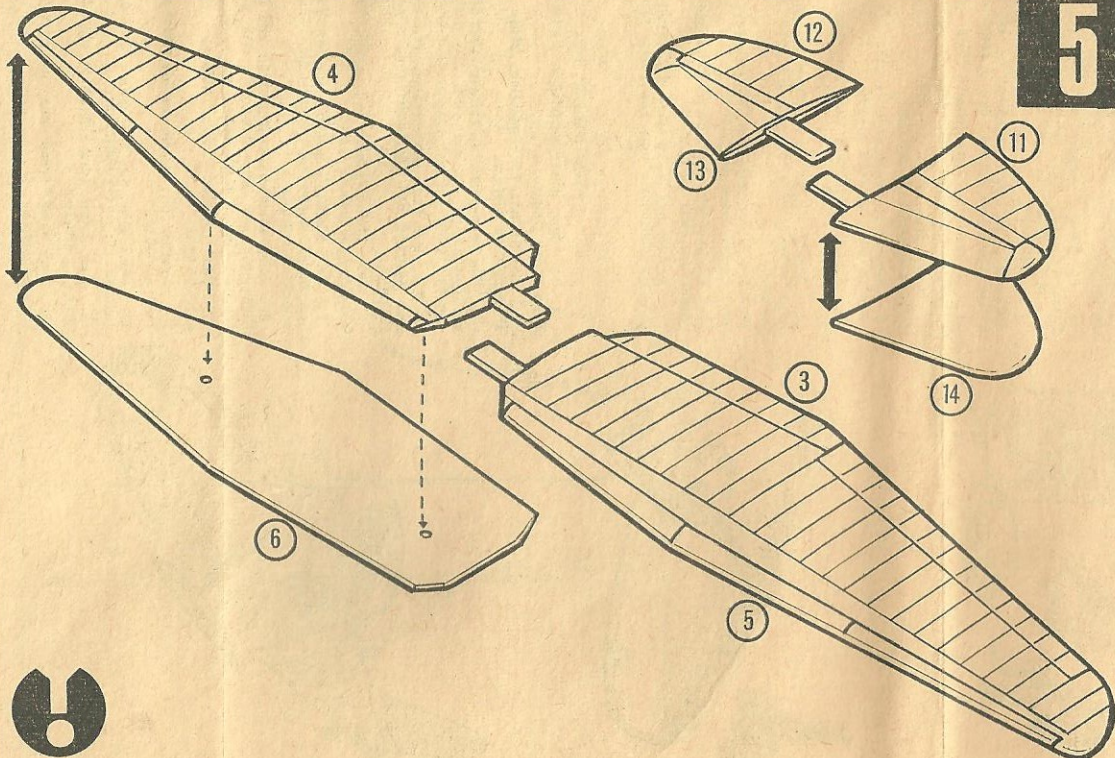

6

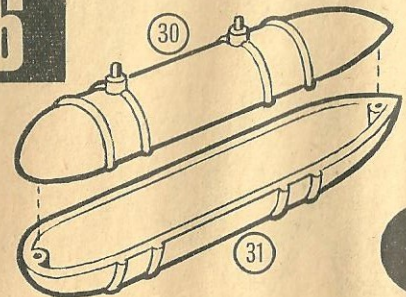

6

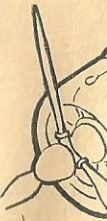

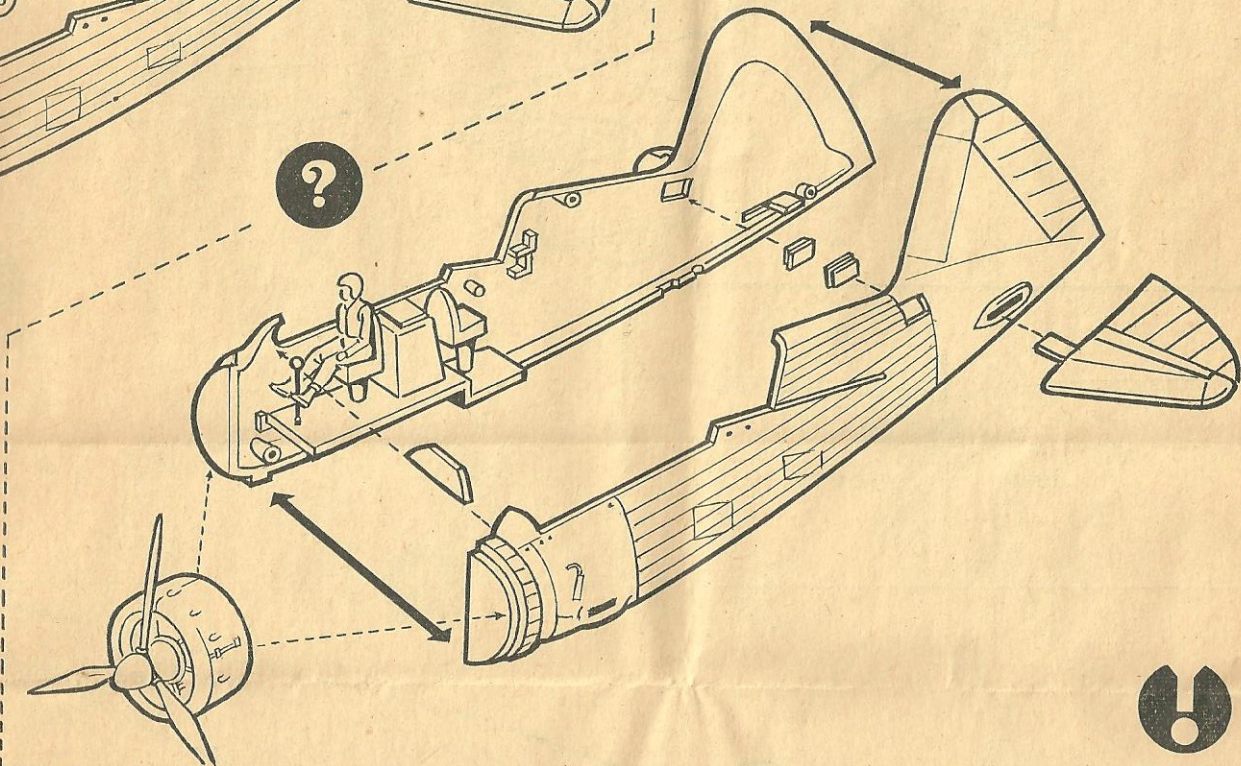
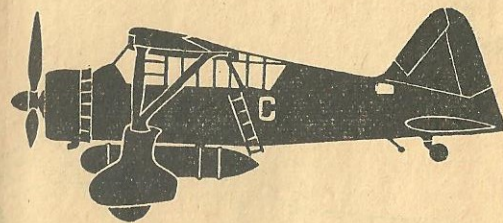
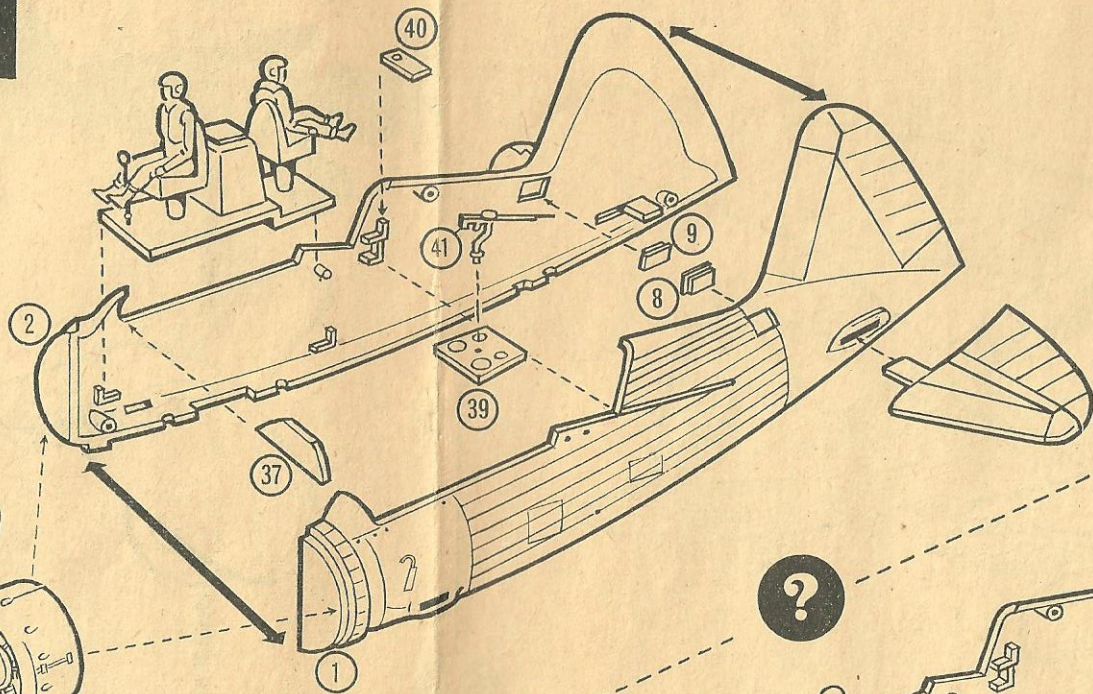

8

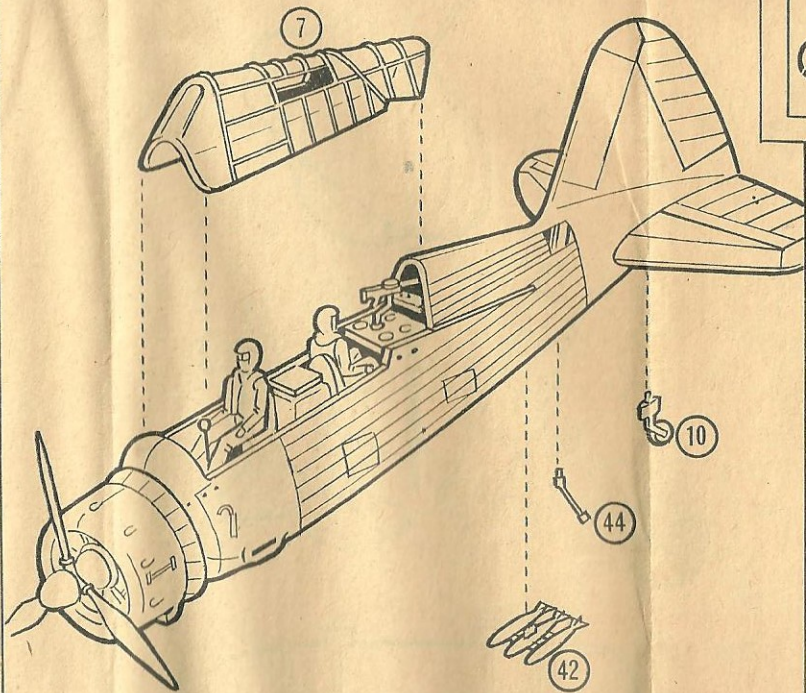

9

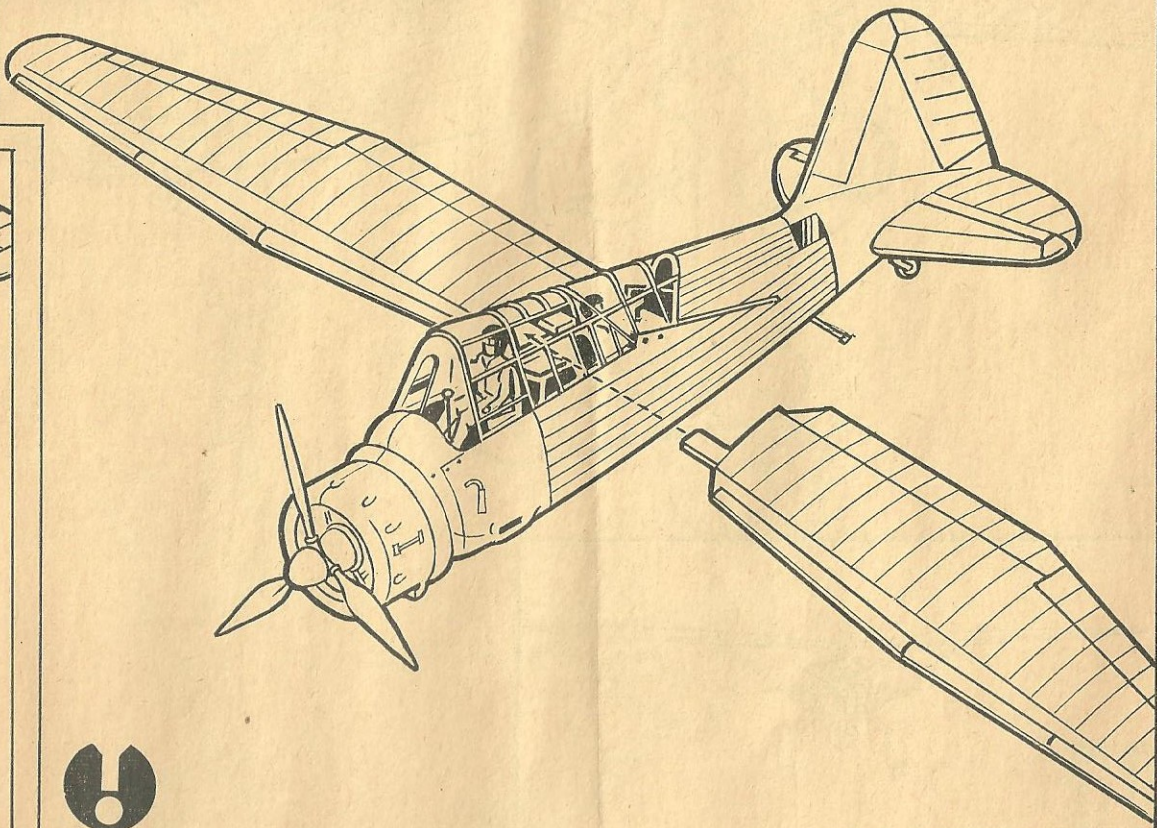

10

