

ASSEMBLY INSTRUCTIONS

OZMODS' 1/144 DHC-4 CARIBOU

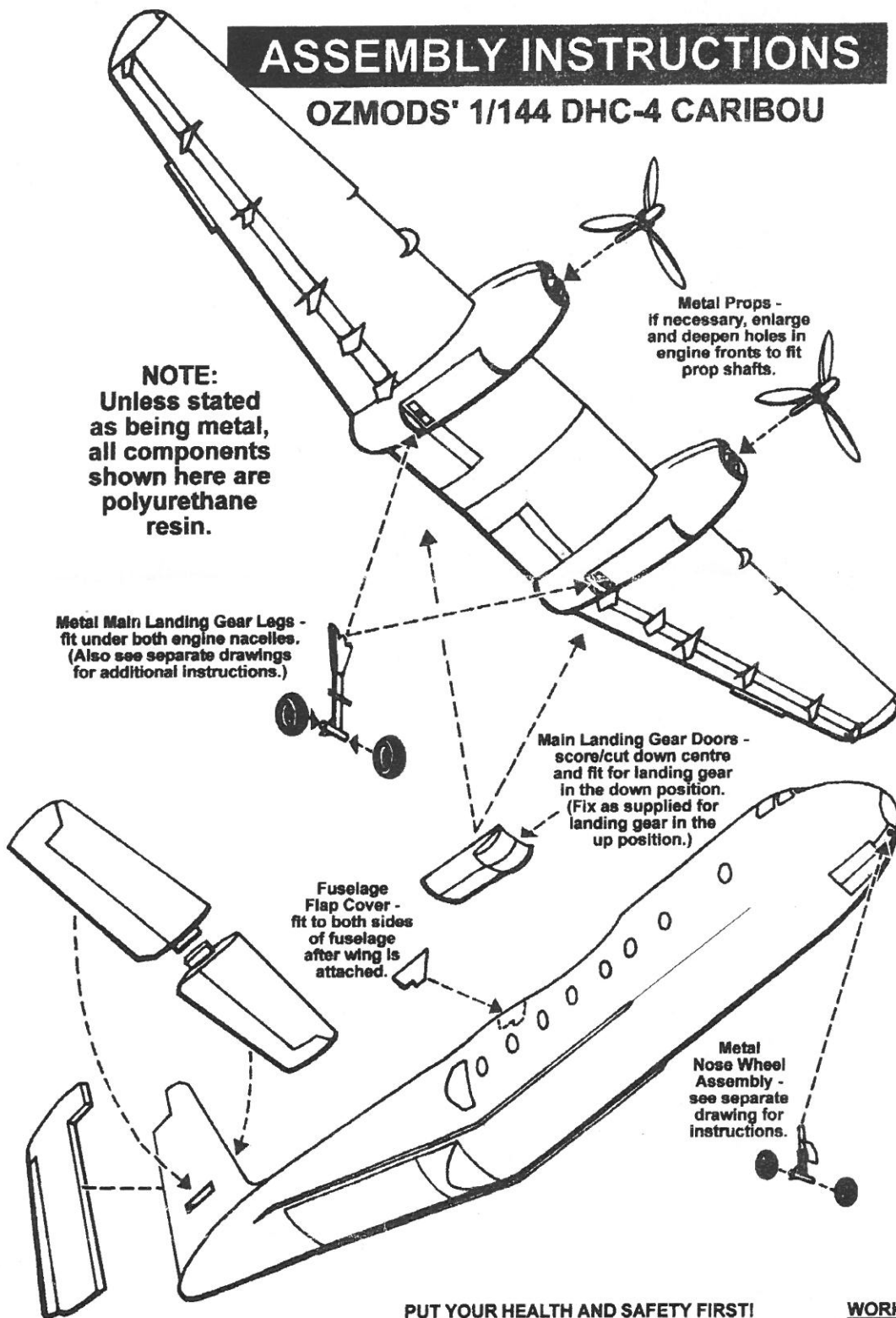

MAIN LANDING GEAR ASSEMBLY DETAILS

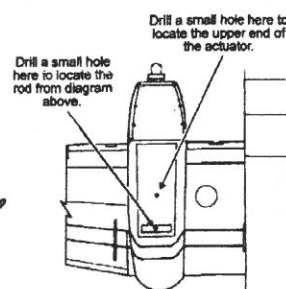
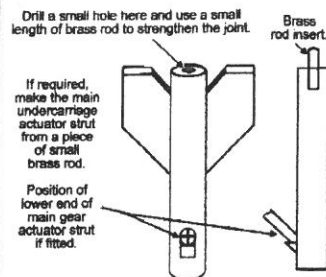

NOSE LANDING GEAR ASSEMBLY DETAILS

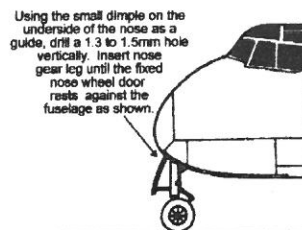

PUT YOUR HEALTH AND SAFETY FIRST!

● The plastic parts of this kit are moulded in polyurethane. As with any type of plastic, wear a dust mask or other protective breathing device to avoid inhalation of dust particles when sanding.

Where sanding is required, it is strongly advised that wet and dry sandpapers be used - always work with water as this traps the resin dust and minimises inhalation of particles.

Also wash hands and parts thoroughly when you have completed sanding work.

● When using Superglue or Two-Part Epoxy glues, take precautions to avoid skin and eye contact and breathing in the fumes of such glues.

The use of barrier cream on hands or wearing disposable gloves, and working in a well-ventilated area, is strongly recommended.

● Also be cautious when cutting and sawing parts - take special care when using sharp blades to avoid any injury to yourself.

WORKING WITH RESIN

The polyurethane resin used in the manufacture of this kit has similar characteristics to styrene - however, like styrene, it can break if subjected to excessive bending pressures.

Here are a few tips to help make the job easier:

* To remove parts attached to runners, simply cut off with a blade or, where they are joined with a 'gate', score this with a knife and gently snap them off.

* Remove any flash by gently snapping off with a finger, or cutting with a scalpel.

* Clean up parts (i.e., where 'gate' joiners have left a protrusion) as you would with a styrene part - carefully cut or scrape with a sharp blade.

* Gently sand mating surfaces prior to gluing together (see "Put Your Health and Safety First").

* Use Superglue or Two-Part Epoxy to fix the plastic and photoetched parts (see "Put Your Health and Safety First").

* Before painting, it is recommended that the parts first be washed, dried and coated with a primer before applying the finishing colours.

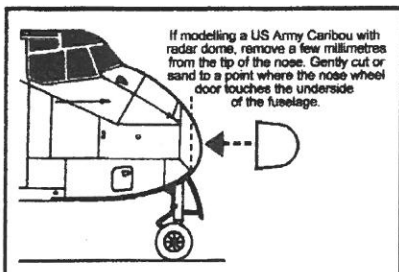

CLEAR COCKPIT CANOPY

For advanced modellers who wish to detail the cockpit, a vacuumformed transparent canopy (plus spare) is supplied with this kit.



NEW FROM

OZMods

**1/144 INJECTED
BRISTOL MK 31
FREIGHTERS**

Check them out at

www.ozmods-kits.com

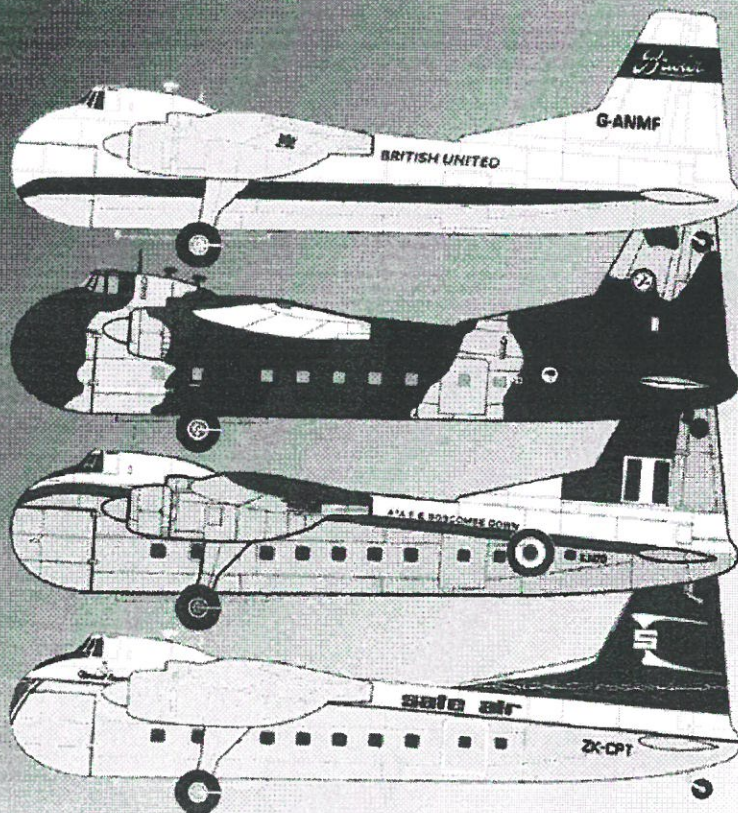

OZMods

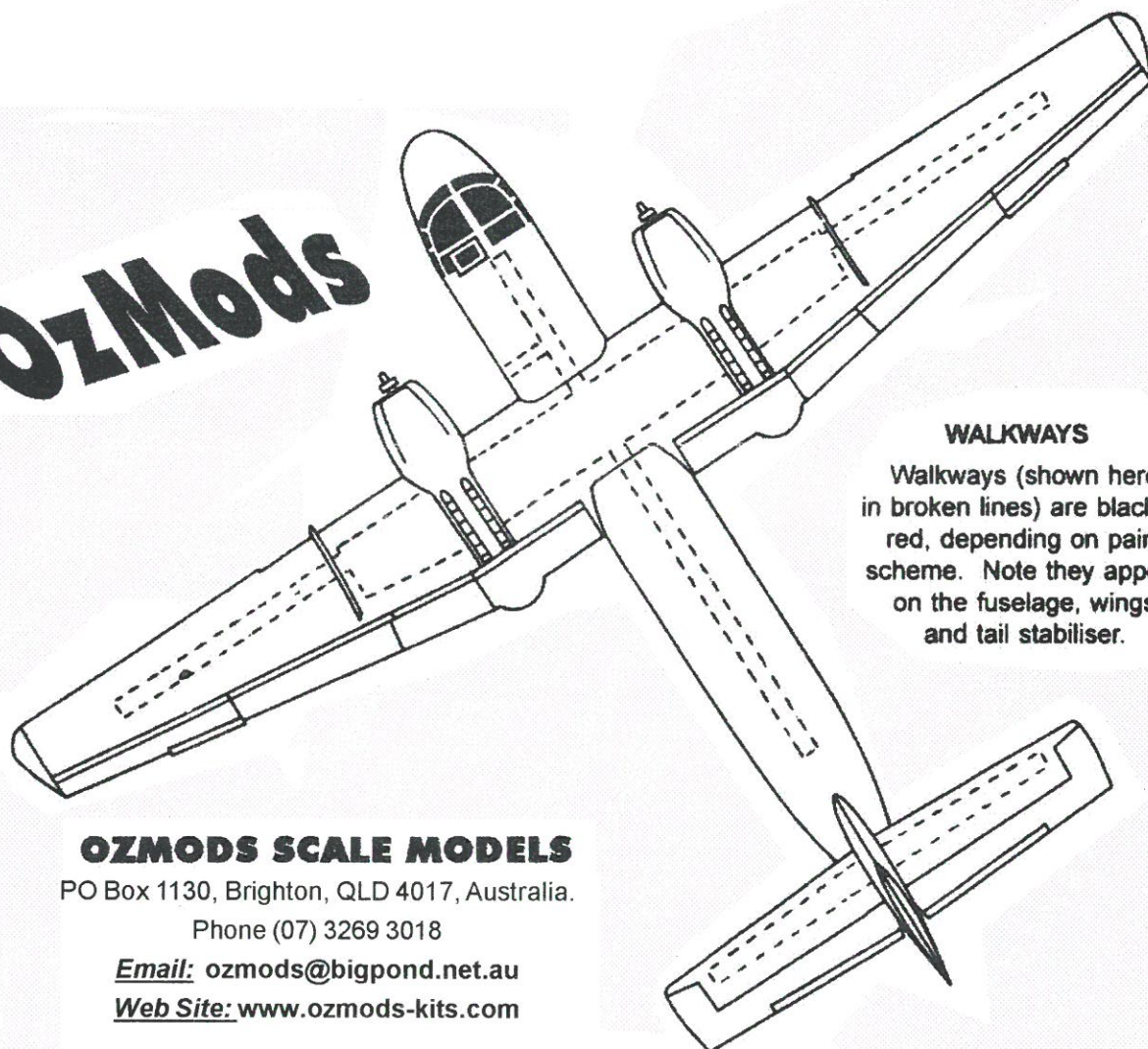

WALKWAYS

Walkways (shown here in broken lines) are black or red, depending on paint scheme. Note they appear on the fuselage, wings and tail stabiliser.

OZMODS SCALE MODELS

PO Box 1130, Brighton, QLD 4017, Australia.

Phone (07) 3269 3018

Email: ozmods@bigpond.net.au

Web Site: www.ozmods-kits.com

DE HAVILLAND CANADA DHC-4A (C-7) CARIBOU

SPECIFICATIONS

Powerplants: Two Pratt & Whitney R2000 Twin Wasp 14 cylinder, two row, air cooled radial engines with single speed supercharger - rated at 1,450 HP for take-off. Three blade constant speed, fully feathering and reversible Hamilton Standard propeller of 3.99 metres diameter. Fuel capacity 3,137 litres in two wing tanks each comprising 10 cells.

Dimensions: Wing span 29.15 metres; Wing area 84.72 square metres; Length 22.13 metres; Tailplane span 10.97 metres; Height 9.66 metres; Wheelbase 7.29 metres; Wheel track 7.05 metres.

Weights: Maximum take-off and landing 12,927 kg; Operational empty 8,283 kg; Maximum payload 8,740 kg.

Performance: Maximum speed (at maximum take-off weight) 348 km/h at 2,000 metres; Economical cruise 293 km/h at 2,500 metres; Take-off run 221 metres; Landing roll 204 metres; Initial rate of climb 413 metres/minute; Service ceiling 7,560 metres; Engine out ceiling 2,682 metres; Range (with 45 minute reserve at economical cruise) 2,100 km with maximum fuel, or 389 km with maximum payload.

Accommodation: Flight crew of two (plus loadmaster) plus 32 troops or 26 fully equipped paratroops on inward facing seats; or 22 stretcher patients and eight seated patients or medical attendants.

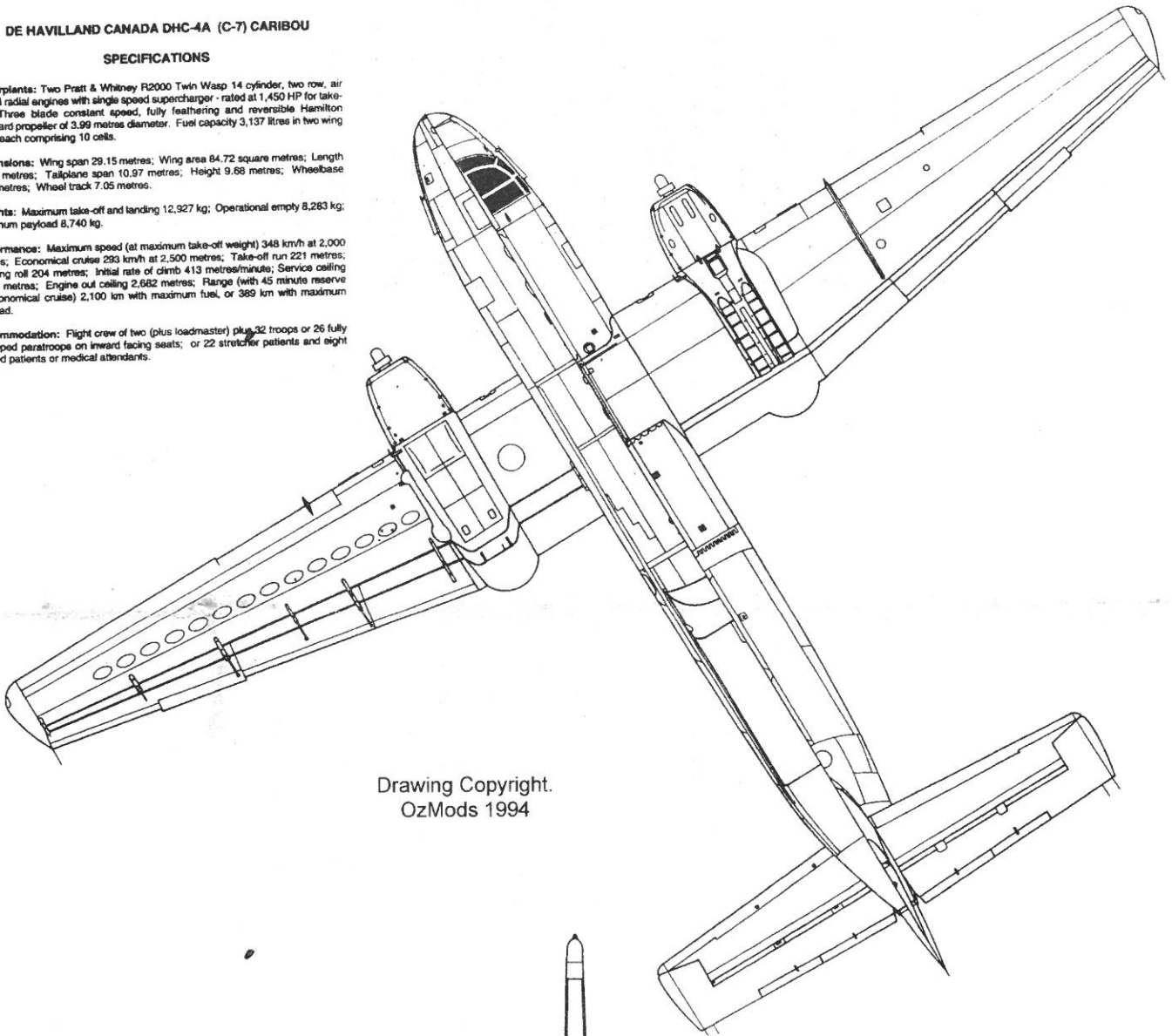

Drawing Copyright.
OzMods 1994

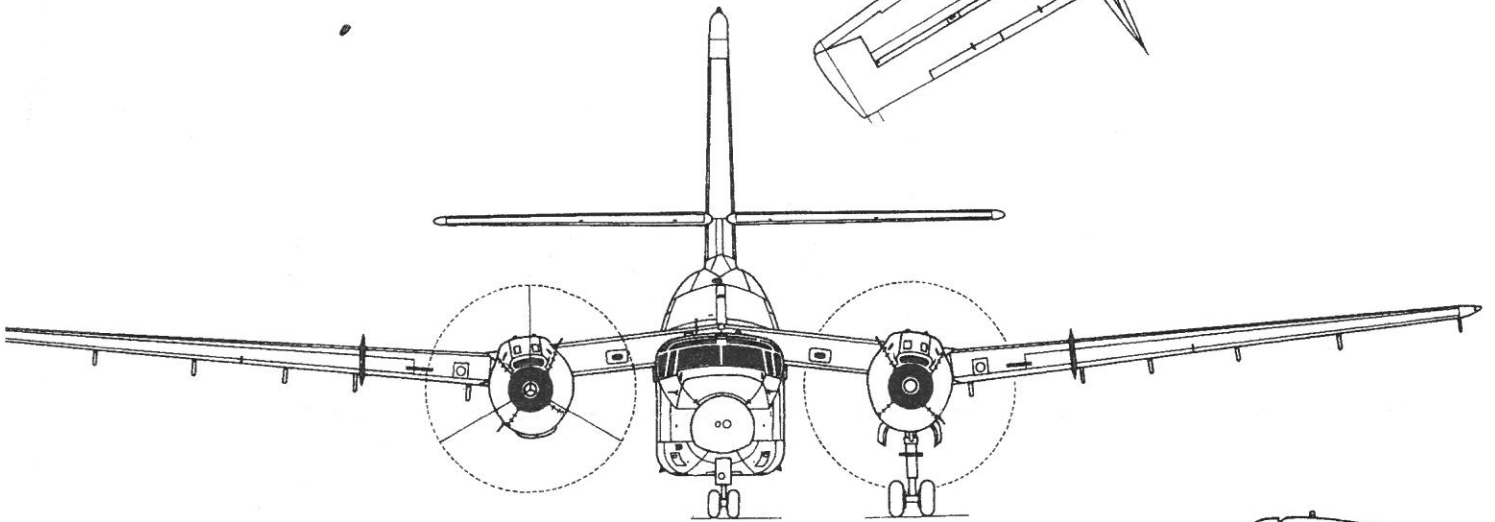

DETAILS

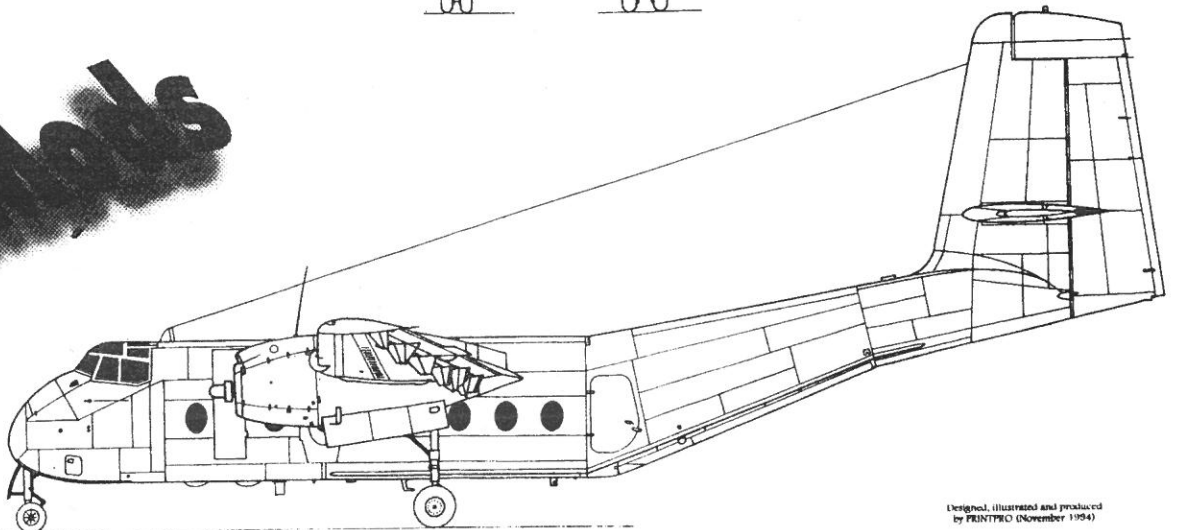

OZMODS[®] (in Aus\$)

RETAIL PRICES 2017

AIRCRAFT CONSTRUCTION KITS

OMKIT14401 - 1/144 DHC-4 Canbou (R, VC, M, D)	\$39.60
OMKIT14402 - 1/144 Mig-15/17 (IM, VC, D)	\$14.30
OMKIT14403 - 1/144 F-86 Sabre (IM, VC, D)	\$14.30
OMKIT14404 - 1/144 Lockheed T-33 (IM, VC, D)	\$14.30
OMKIT14405 - 1/144 EA Canberra B2 (IM, VC, D)	\$27.50
OMKIT14406 - 1/144 Mig-15bis (IM, VC, D)	\$14.30
OMKIT14407 - 1/144 F9 Panther (IM, VC, D)	\$14.30
OMKIT14408 - 1/144 F-87B Canberra (IM, VC, R, D)	\$27.50
OMKIT14409 - 1/144 F-80 Shooting Star (IM, VC, D)	\$14.30
OMKIT14410 - 1/144 EE Canberra B109 (IM, VC, D)	\$27.50
OMKIT14411 - 1/144 Bae Hawk T.1 (IM, IC, VC, D)	\$14.30
OMKIT14412 - 1/144 Bae Hawk T.2 (IM, VC, D)	\$14.30
OMKIT14413 - 1/144 Bell P-39 Airacobra (R, IC, D)	\$25.30
OMKIT14414 - 1/144 F-86D Sabre (IM, IC, VC, D)	\$15.40
OMKIT14415 - 1/144 F95 Panther (IM, IC, VC, D)	\$15.40
OMKIT14418 - 1/144 Bristol Freighter - SAFE, BU (IM, IC, VC, D)	\$49.50
OMKIT14419 - 1/144 Bristol Freighter - RAF, RNZAF (IM, IC, VC, D)	\$49.50
OMKIT14420 - 1/48 DHC-4 Canbou (V, R, M, D)	OOB
OMKIT14421 - 1/72 Piliatus PC-9 - RAF, RTAF (IM, R, IC, VC, D)	OOB
OMKIT14422 - 1/72 Piliatus PC-9 - RAAF, RAF (IM, R, IC, VC, D)	OOB
OMKIT14423 - 1/72 Piliatus PC-9 - RAAF, RAF (IM, R, IC, VC, D)	OOB
OMKIT14424 - 1/72 Piliatus PC-9 - RAAF, RAF (IM, R, IC, VC, D)	OOB
OMKIT14425 - 1/72 Piliatus PC-9 - RAAF, RAF (IM, R, IC, VC, D)	OOB
OMKIT14426 - 1/72 Piliatus PC-9 - RAAF, RAF (IM, R, IC, VC, D)	OOB
OMKIT14427 - 1/72 Piliatus PC-9 - RAAF, RAF (IM, R, IC, VC, D)	OOB
OMKIT14428 - 1/72 Piliatus PC-9 - RAAF, RAF (IM, R, IC, VC, D)	OOB
OMKIT14429 - 1/72 Piliatus PC-9 - RAAF, RAF (IM, R, IC, VC, D)	OOB
OMKIT14430 - 1/72 Piliatus PC-9 - RAAF, RAF (IM, R, IC, VC, D)	OOB

*IM - Injection Moulded; R = Resin; V = Vacuum Formed; VC = Vacuum Canopy; IC = Injection Canopy; M = Metal Parts; D = Decals

NAVAL CONSTRUCTION KITS

OMKIT3501 - 1/3500 HMAS Vampire (resin, p/etch, decals)	\$165.00
OMKIT6001 - 1/6000 HMAS/HMS Duchess (resin, decals)	\$39.60
OMKIT6002 - 1/6000 HMAS Voyager (resin, p/etch, decals)	\$39.60
OMKIT7001 - 1/7000 HMAS Vampire (resin, p/etch, decals)	\$39.60
OMKIT7002 - 1/7000 HMAS Vendetta (resin, p/etch, decals)	\$39.60

OZMODS'S 1/48 CONVERSION/ACCESSORY PACKS (Resin)

OZCONV4801 - C-130A Hercules Conversion	\$22.00
OZCONV4802 - Douglas A-26K Invader Conversion	\$17.60
OZCONV4803 - F-111 Wing Tanks	\$17.60
OZCONV4804 - F-111 Wing Tank	\$6.60
OZCONV4805 - RAAF Macchi MB326H 90Gal Tanks (injected)	\$6.60
OZCONV4806 - RAAF Macchi MB326H 90Gal Tanks	\$6.60
OZCONV4807 - Macchi MB326H Tanks, Flaps, Nose Leg	\$12.10
OZCONV4808 - ASRAAM Missiles (2 per pack)	\$6.60
OZCONV4809 - SUU-20 Practice Bomb Units (2 per pack)	\$8.70
OZCONV4810 - Macchi 326 Cockpit Upgrade	\$17.60
OZCONV4811 - F-111 canopy (vacform, 2 per pack)	\$16.50
OZCONV4812 - F-111 Tailpipes & Afterburner Cans (2 per pack)	\$16.50
OZCONV4813 - F-111 Flare/Chaff Dispensers (2 per pack)	\$7.60
OZCONV4814 - Martin Baltimore engine cowlings (2 per pack)	\$8.80
OZCONV4815 - AMRAAM + Sidewinder 9X + launch rail (1 set)	\$12.10
OZCONV4816 - HARM Missiles + launch rails (2 per pack)	\$12.10
OZCONV4817 - Lockheed Hudson Tail, Rudder, Elevator (conversions for the Classic Airframe's kit)	\$22.00
OZCONV4818 - Lockheed Hudson Bomb Bay & Doors	\$16.50
OZCONV4819 - P-8W R-1930 Twin Wasp Radial (2 per pack)	\$7.60
OZCONV4820 - Vulture Vengeance Fuselage Correction (for A-Z kit)	\$66.00
OZCONV4821 - F-111 Heavy Wheel Set (for BC/GFB models)	\$13.20
OZCONV4822 - Macchi 326 Vacuum Canopy (2 per pack)	\$9.90

OZMODS-SCALEDOWN 1/48 CONVERSION/ACCESSORY PACKS (Resin)

SDA48001 - F-111 Long Span Wings/Flaps/Slats Set	\$88.00
SDA48002 - F-111 Afterburner Cans	\$16.50

SDA48003 - <u>Set A</u> F-111A, D, E, F, EF-111A Wheels & Tyres	\$16.50
SDA48003 - <u>Set B</u> F-111C, G, FB-111A Wheels & Tyres	\$16.50
SDA48004 - F-111/FB-111A Conversion Set	\$23.20
SDA48005 - EF-111A U/C Doors and Canoe Fitting	\$23.20
SDA48006 - F-111 Undercarriage Doors	\$14.30
SDA48007 - F-111 BRUs + 12 x Mk 82/MAU-93B LDGP Bombs	\$25.30
SDA48008 - F-111 Short Span Wings/Flaps/Slats Set	\$92.50
SDA48010 - F-111A, C, D, E, F Long-range Fuel Tanks	\$25.30
SDA48011 - F-111/FB-111A Long-range Fuel Tanks	\$25.30
SDA48012 - F-111 BRUs + 12 x Mk 81/BSU-348 LDGP Bombs	\$25.30
SDA48013 - F-111 BRUs + 12 x Mk 82/BSU-49B AIR Bombs	\$25.30
SDA48014 - F-111 BRUs + 12 x Mk 82/Mk 15 Snakeeye Bombs	\$25.30
SDA48015 - F-111 BRUs + 12 x CBU Bombs	\$25.30
SDA48017 - B-61 Nuclear Bombs (2 per pack)	\$16.50
SDA48020 - F-111 Wheel Well and Undercarriage Set	\$93.50
SDA48026 - AGM-69 SRAMs (2 per pack)	\$16.50
SDA48027 - GBU-10B PAVE Way 1 LGBs (2 per pack)	\$25.30
SDA48014 - F-111 BRUs with 12 x M117 LDGP Bombs	\$25.30
SDA48044 - F-111 BRU-3A/A Bomb Rack Units (2 per pack)	\$13.20
SDA48046 - F-111 Wing + Sidewinder Rails (2 per pack)	\$7.60
SDA48045 - F-111 Pylon Sweep Covers	\$8.80
SDA48047 - Mk 83 1,000lb Bombs (4 per pack)	\$16.50
SDA48048 - EF-111A Trophy Tail	\$16.50
SDA48049 - F-111B Trophy Tail	\$14.30
SDA48050 - F-111A, C, D, E, F, G Trophy Tail	\$14.30
OZCONV4804 - F-111 Pave Tack Pod	\$6.60
SDA48051 - Spitfire High Altitude Wing Tips	\$6.60
SDA48053 - P-28W R-2800 Double Wasp Engine (2 per pack)	\$19.80
SDA48054 - P-28W R-2800 1b Grand Slam Bomb	\$23.10
SDA48055 - Saturn V F-1 Engine Set (5 Engine Belts)	\$220.00
SDA48056 - Saturn V Detail Set A (External Stage Fairings etc)	\$99.00
SDA48057 - Saturn V Detail Set B (S-IC engine plate & heat shields, 4 x S-IC fins)	\$99.00

OZMODS'S 1/32 CONVERSION/ACCESSORY PACKS (Resin)

OZCONV3201 - ASRAAM Missiles (2 per pack)	\$9.90
OZCONV3202 - Multiple Ejector Rack (2 per pack)	\$12.10
OZCONV3203 - Mk 82 Low Drag GP Bombs (x6)	\$17.60

OZMODS'S 1/72 CONVERSION/ACCESSORY PACKS (Resin)

OZCONV7201 - C-130A Hercules Conversion	\$17.60
OZCONV7202 - RAAF CH-47C Chinook conversion	\$12.10
OZCONV7203 - AF-121 and WV-2 Constellation Conversion	\$19.80
OZCONV7204 - Northrop F-5 Wing Tip Tank	\$3.30
OZCONV7205 - Douglas DC-3 Passenger Door	\$3.30
OZCONV7206 - RAAF Macchi MB326H 90Gal Tanks	\$4.40
OZCONV7208 - SUU-20 Practice Bomb Units (2 per pack)	\$6.60
OZCONV7209 - Bristol Centaurus & 4 Blade Prop (2 per pack)	\$11.00
OZCONV7210 - Bristol Sycamore Clear Windshield & Windows	\$11.00
OZCONV7211 - C-130J Nacelle Correction (for kaleri kit)	\$22.00
OZCONV7212 - C-130J Engine Exhaust Pipes (4 per pack)	\$5.50
OZCONV7213 - C-130J Engine Exhaust Pipes (4 per pack)	\$5.50
OZCONV7214 - C-130J 6-Blade Prop Assembly Jig	\$5.50
OZCONV7215 - Bae Harrier Gun Pods (2 per pack)	\$5.50
OZCONV7216 - C-130A Hercules Conversion (Replaces 7201. Set contains nacelles, exhaust sections, spinners, blades, tanks, windows)	\$27.50

OZMODS-SCALEDOWN 1/72 CONVERSION/ACCESSORY PACKS (Resin)

SDA72017 - B-61 Nuclear Bombs (2 per pack)	\$9.90
SDA72025 - AGM-69 SRAMs (4 per pack)	\$13.20
SDA72046 - GBU-28 Deep Throat LGB (1 bomb per pack)	\$9.90

OZMODS'S 1/48 CONVERSION/ACCESSORY PACKS (Resin)

OZCONV14401 - Flaps & Speed Brakes (for OzMod's Canberras)	\$5.50
OZCONV14402 - RB-57D Conversion (for OMKIT14408) + Decals	\$18.70
OZCONV14403 - Modern Weapons	See next column
OZCONV14404 - WW2 Korean War Weapons	See next column

OZCONV14405 - Modern Russian Weapons	See last column
OZCONV14406 - WW2 Pilot Figures	See last column
OZCONV14407 - Modern Aircraft Parts	See last column
OZCONV14408 - Modern Pilot Figures	See last column
OZCONV14410 - F-111B/C/G Long Wings & Intakes (for Ari Kit)	\$9.90
OZCONV14411 - F-111B (Naval) Short Nose & Pod (for Ari Kit)	\$8.80
OZCONV14412 - F-111B/C/W/W/Intakes, Cockpit, Vac Canopy (for Ari Kit)	\$9.90
OZCONV14412VC - F-111C Vacuum Canopy (2 per pack)	\$4.40
SDA14401 - EF-111A Conversion - Tail, Gondola, Aerials	\$8.80
SDA14402 - FB-111/AVG Conversion - Tail Intakes	\$6.60
SDA14403 - F-111 Prototype Fin and Intakes	\$6.60
SDA14405 - F-111A/B/C Intakes. For the Ari kit	\$3.30
OZCONV14413 - Boeing 727-100 Short Fuselage (AriKit kit, etc)	\$22.00
OZCONV14414 - Boeing 717 Fin/Engines/Tail Cone (for DC-9 kits)	\$14.30
OZCONV14415 - B-57G Conversion (for OMKIT14408) Decals	\$12.10
OZCONV14416 - Mig-23/27 Conversions and Upgrades	\$12.10
OZCONV14417 - F-1A-18 Hornet Tanks, Tylons, Bomb Carriers	\$9.90
OZCONV14418 - EA-6A-6 Tanks (2 per pack)	\$4.40
OZCONV14419 - ECM High Frequency Jammer Pods (2 per pack)	\$5.50
OZCONV14420 - Retruffing Pod for US Navy Jets (one per pack)	\$3.50
OZCONV14421 - C-2A Greyhound Conversion (Revel Hawkeye)	\$22.00
OZCONV14422 - 8-blade props (2 per set, for Revell F-9 Hawkeye and OzMod's C-2A Greyhound)	\$8.80

OZMODS'S 1/144 Modern Weapons (OZCONV14403)

AIM-4D Falcon missile (2 per pack)	\$3.00
AIM-7 Sparrow missile (4 per pack)	\$5.50
AIM-9L Sidewinder missile (2 per pack)	\$4.00
AIM-54 Phoenix missile (2 per pack)	\$4.00
AIM-120 AMRAAM (4 missiles & 2 launcher boots per pack)	\$5.00
AIM-132 ASRAAM missile (2 per pack)	\$4.00
AGM-12B Bulldog (2 per pack)	\$4.00
AGM-12C Bulldog missile (2 per pack)	\$3.50
AGM-62 Walleye (2 per pack)	\$4.00
AGM-69 SRAM (2 per pack)	\$4.50
AGM-84 Harpoon missile (2 per pack)	\$5.00
AGM-84E SLAM (2 per pack)	\$4.00
BLU-27 Napalm (2 per pack)	\$4.00
GBU-8 TV Guided bomb (2 per pack)	\$4.00
GBU-12 Laser Guided bomb (2 per pack)	\$3.00
GBU-10 Laser Guided bomb (2 per pack)	\$4.00
GBU-31 JDAM (2 per pack)	\$4.00
GBU-38 JDAM (2 per pack)	\$3.50
Mk 20 Rockeye (2 per pack)	\$3.50
Mk 82 Bombs (6 per pack)	\$4.50
Mk 83 Bombs (4 per pack)	\$4.50
Mk 84 Bombs (2 per pack)	\$4.50
Mk 82 Snake Eyes bombs (6 bombs + 2 Triple Ejector Rack)	\$5.50
Mk 117 750lb bombs (4 per pack)	\$4.00
ALG-119 ECM Pod (1 per pack)	\$2.00
7.62 mm Mini Guns (in mounts for helicopters - 2 per pack)	\$3.00
FB-111/G Pylon (2 per pack)	\$2.00
F-111 Long Range Tanks (2 per pack)	\$6.50
F-111 Pave Tack Pod (one per pack)	\$2.00
AM39 Exocet missile (2 per pack)	\$5.00
Multiple Ejector Rack (2 per pack)	\$3.00
SUU-30 Dispenser (2 per pack)	\$3.00

OZMODS'S 1/144 WW2 Korean War weapons (OZCONV14404)

US 500lb bombs (4 per pack)	\$4.50
US 250lb bombs (4 per pack)	\$4.00
US 3" Rocket Projectiles (6 per pack)	\$3.00
30 CAL Browning Machine Guns (2 per pack)	\$3.00
50 CAL Browning Machine Guns (2 per pack)	\$3.00
TYPE 99 II 20mm (Japanese) Cannon (2 per pack)	\$3.00
Japanese Type 97 7.7 mm Machine Gun (pack of 2)	\$3.00
3" British Rocket Projectiles on rails (6 per pack)	\$3.00

OZMODS'S 1/144 Modern Russian Weapons (OZCONV14405)

AA-2 Atol (pack of 2)	\$4.00
AA-6 Acrid D (pack of 2)	\$7.00
AA-7 Apex (pack of 2)	\$5.00
AA-10 Alamo A (pack of 2)	\$6.00
AA-11 Archer (pack of 2)	\$4.00
AS-7 Kerry (pack of 2)	\$5.00
AS-10 Karen (pack of 2)	\$5.00
AS-11 Killer (pack of 2)	\$5.00
AA-12 Adder (pack of 2)	\$4.00
AS-13 Kingbolt (pack of 2)	\$6.00
AS-14 Kedje (EO) (pack of 2)	\$5.00
AS-14 Kedje (L) (pack of 2)	\$5.00
AS-18 Kazoo (pack of 2)	\$7.00
AS-20 Kayak (pack of 2)	\$6.00
FAB-100 (100kg) Bombs (pack of 4)	\$3.50
FAB-250 (250kg) Bombs (pack of 4)	\$4.00
FAB-500 (500kg) Bombs (pack of 4)	\$4.50
1000kg LGBs (pack of 2)	\$5.00

OzMod's 1/144 WW2 Pilot Figure (OZCONV14406)

Japanese (standing - 2 figures per pack)	\$3.50
RAF/RAAF (standing - 2 figures per pack)	\$3.50
USAAF (standing - 2 figures per pack)	\$3.50
Generic (seated - 2 figures per pack)	\$3.50
Parachute pack (2 per pack)	\$2.00

OzMod's 1/144 Modern Aircraft Parts (OZCONV14407)

Martin Baker E/Seats (Canberra, Hunter, Lightning, etc - 2 per pack)	\$3.50
20mm Gun Pack (converts OzMod's B2 Canberra to B1f6)	\$3.50

OzMod's 1/600 Ship Parts (OZCONV14408)

Replacement turrets for AriKit 1/600 HMS Ajax (Set of 6 per pack)	\$7.60
---	--------

OzMod's 1/144 Modern Pilot Figures (OZCONV14409)

Russian Long-Range Aviation Pilot (2 figures per pack)	\$3.50
Generic (seated - 2 figures per pack)	\$3.50

OZMODS'S 120 mm (116) MILITARY FIGURES (Resin)

OZFIG001 - Australian Bren Gunner (Pacific WWII)	\$60.00
OZFIG002 - ANZAC in Great Coat (Middle East WWII)	\$70.00
OZFIG003 - Resting Digger (North Africa, WWII)	\$60.00
OZFIG004 - Private Dingo Harris, Australian Commando (New Guinea WWII)	\$55.00
OZFIG005 - Bren Gunner, Action Pose (Pacific WWII)	\$70.00
OZFIG006 - Royal Pacific Island Regiment (WWII)	\$50.00
OZFIG007 - AIF Western Front (1917, WWI)	\$50.00
OZFIG008 - "River Crossing" (Digger, New Guinea, WWII)	\$45.00

OZMODS'S 120 mm (116) MILITARY ACCESSORIES (Resin)

OZMIL001 - 303 Rifle	\$6.80
OZMIL002 - Bren Gun	\$6.80

NOTE: Retail prices given here are in Australian Dollars (Aus\$) = US\$0.75, UK£0.64 approx). Prices do not include postage. Payment can be made by PayPal to ozmods@bigpond.net.au or by phone or E-mail with Visa, Mastercard, Bankcard, Amex, Diners, Eurocard - or by post with cheque, bankdraft or money order. Please make cheques, bankdrafts or money orders payable to "OzMods". Minimum Order is Aus\$20.00.

POSTAGE & HANDLING CHARGES WITHIN AUSTRALIA

1/48 Canbou or 1/350 Vampire (for one kit, insured postage)	\$21.00
Kits/conversion packs valued up to \$15.00	\$6.50
Kits/conversion packs valued \$15 to \$40	\$10.00
Kits/conversion packs valued \$40 to \$100	\$16.00 (insured postage)
Kits/conversion packs valued \$100 - \$150	\$20.00 (insured postage)
Overseas postage and handling charges available on request	

OZMODS SCALE MODELS

PO Box 1130, Brighton, QLD 4017, AUSTRALIA.

Phone: (07) 3269 3018

Email: ozmods@bigpond.net.au

Web site: www.ozmods-kits.com



45 Years of Operations

Last Flight of the Royal Australian Air Force DHC-4 Caribou



OzMods
PO Box 5077 Alexander Hills
QLD 4161 Australia
E mail: ozmods@bigpond.net.au
Web Site: www.ozmods-kits.com

Note:
This paint scheme is reproduced from images.
So the pattern may vary slightly.
Aircraft 140, 299 & 236 all have slightly different camo paint schemes
please Refer to images for a more precise guide

www.airliners.net
www.defence.gov.au
www.planepictures.net
www.adf-serials.com
www.oc-kuhuna.com/cv2.html
www.myaviation.net

-  Mat black FS-37038
-  Matt forest green 34079
-  Matt Tea tree green FS-34102

faded / original

When these aircraft were painted in this 45 year of service markings.
The original camo paint scheme was severely faded.

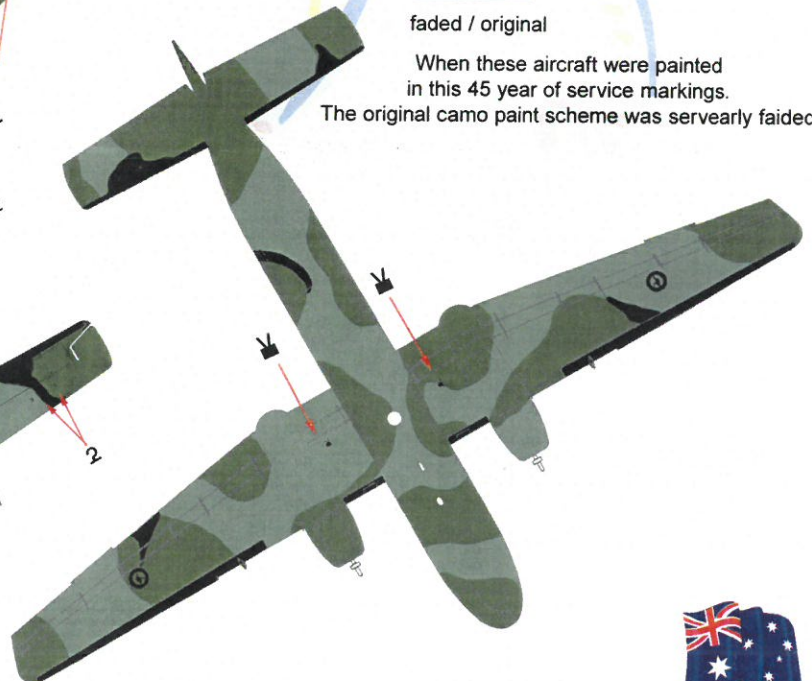
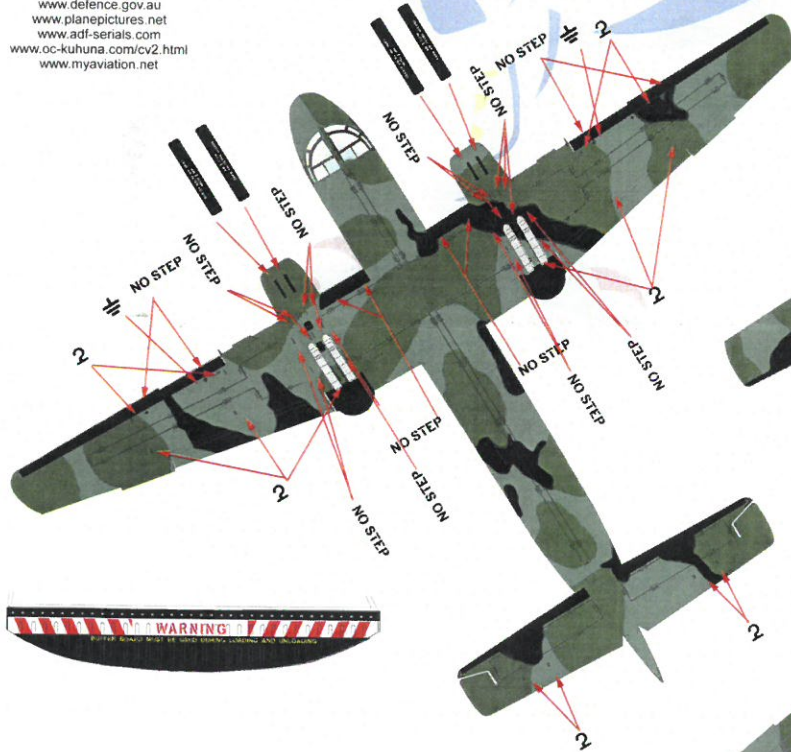

Oz Mods

OMKIT-14401

All Art work is copyright to OzMods and Ronin Graphics





45 Years of Operations

Last Flight of the Royal Australian Air Force DHC-4 Caribou



Light Grey FS-36375



Chrome Yellow FS-13538



OzMods
PO Box 5077 Alexander Hills
QLD 4161 Australia
E mail: ozmods@bigpond.net.au
Web Site: www.ozmods-kits.com

Note:

This paint scheme is reproduced from images. So the pattern may vary slightly.

Aircraft 140, 299 & 236 all have slightly different camo paint schemes please Refer to images for a more precise guide

www.airliners.net
www.defence.gov.au
www.planepictures.net
www.adf-serials.com
www.oc-kuhuna.com/cv2.html
www.myaviation.net

-  Mat black FS-37038
-  Matt forest green 34079
-  Matt Tea tree green FS-34102

faded / original

When these aircraft were painted in this 45 year of service markings. The original camo paint scheme was severely faded.

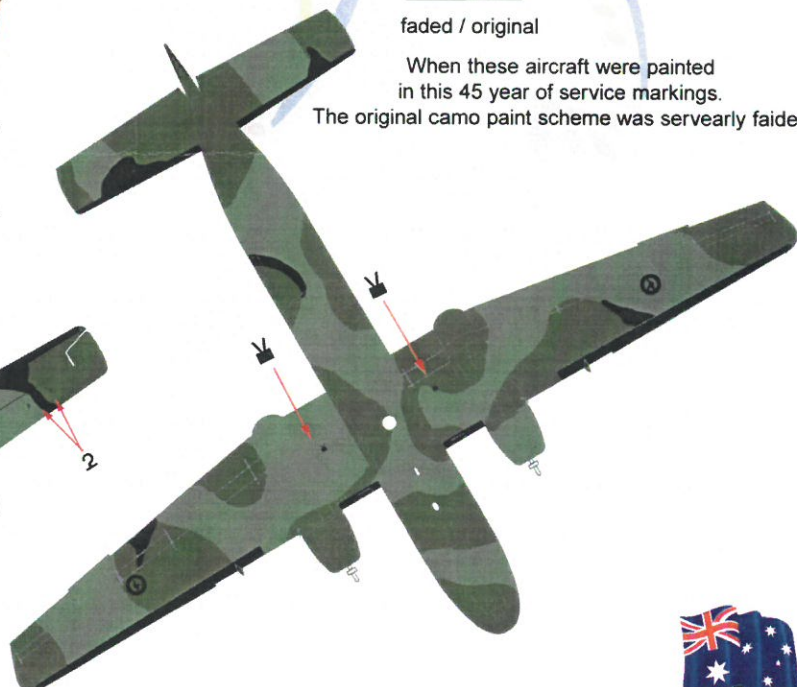
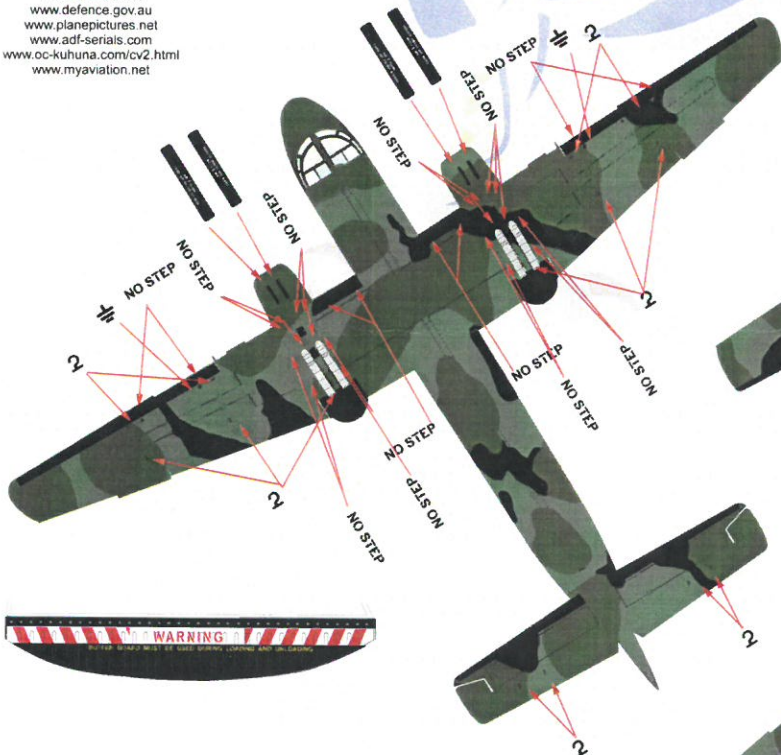

Oz Mods

OMKIT-14401

All Art work is copyright to OzMods and Ronin Graphics



Oz Mods

Spanish Air Force DHC-4A Caribou T9-12
Ala Wing 37 Based at Albacete, Spain
1968 - 1991

Scheme 3

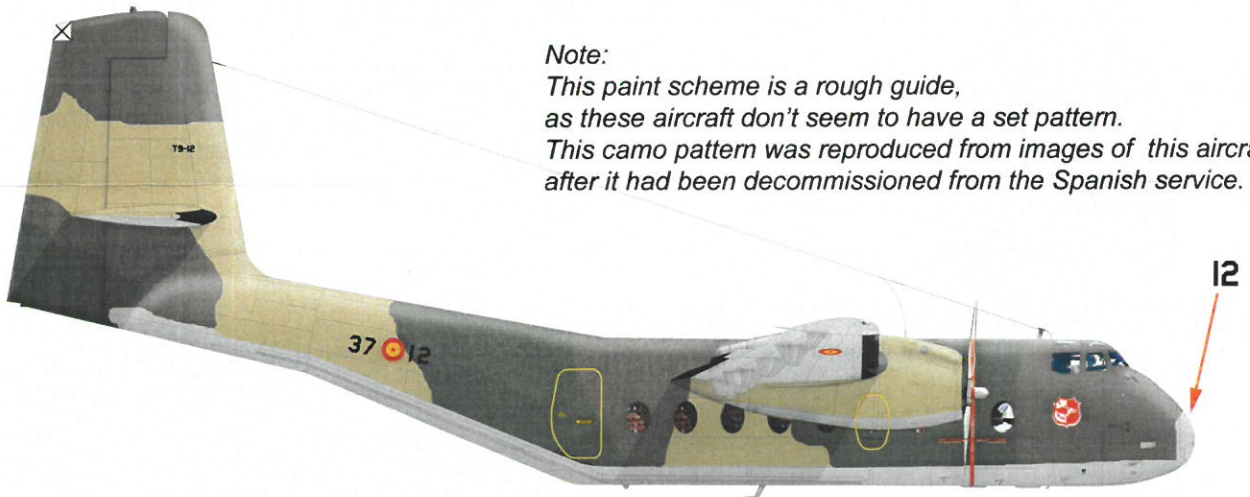

Note:
This paint scheme is a rough guide,
as these aircraft don't seem to have a set pattern.
This camo pattern was reproduced from images of this aircraft
after it had been decommissioned from the Spanish service.

Use Walk Way Lines A

Top & Bottom View
Data Diagram 7
Scheme 3

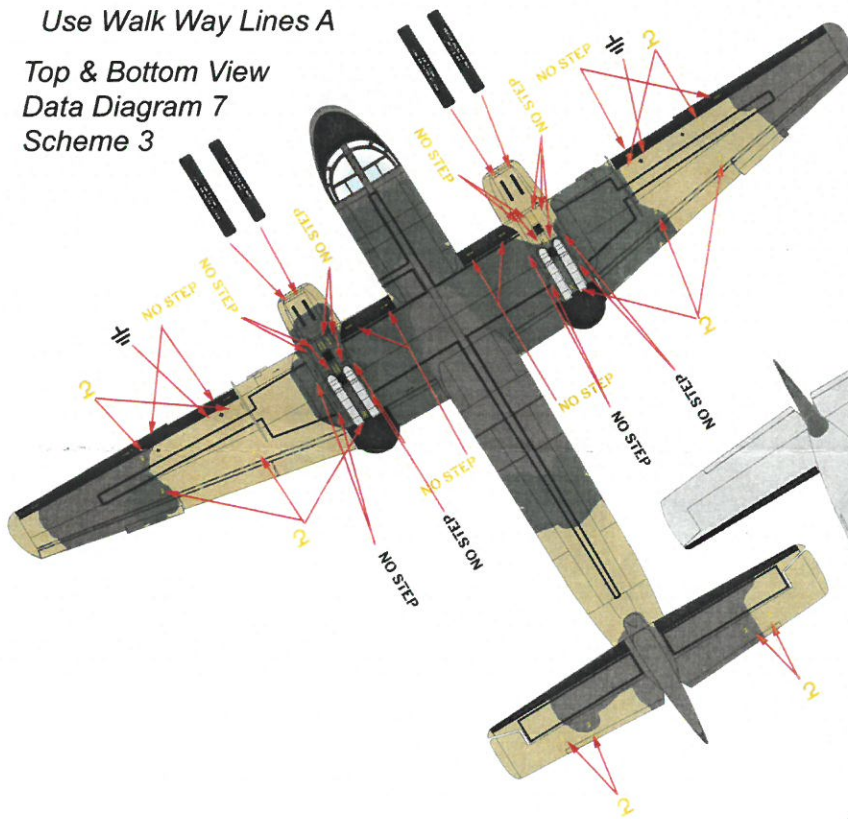

-  Flat Tan FS-30219
or Hum:118
-  Flat Dark Green FS-34102
or Hum:117
-  Flat Yellow Sand FS-33695
or
Flat Light Buff Hum:7
-  Flat Light Grey FS-36375
-  Matt Black FS-37038

OzMods
PO Box 5077 Alexandra Hills
QLD 4161 Australia
E mail: ozmods@bigpond.net.au
Web Site: www.ozmods-kits.com

OMKIT-14401

All Art work is copyright to OzMods and Ronin Graphics

Oz Mods



Oz Mods

Scheme 3

U.S. Air Force
C-7A Caribou
63-9733 535 TAS 483 TAW
Vung Tau AB Vietnam 1969

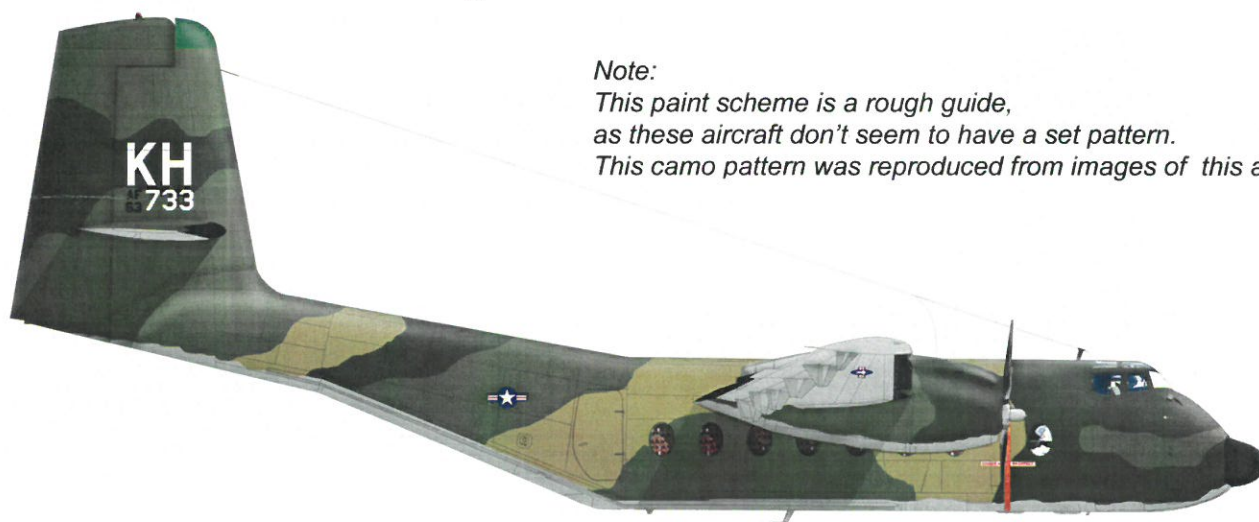

Note:
This paint scheme is a rough guide,
as these aircraft don't seem to have a set pattern.
This camo pattern was reproduced from images of this aircraft

Use Walk Way Lines A

Top & Bottom View
Data Diagram 7
Scheme 3

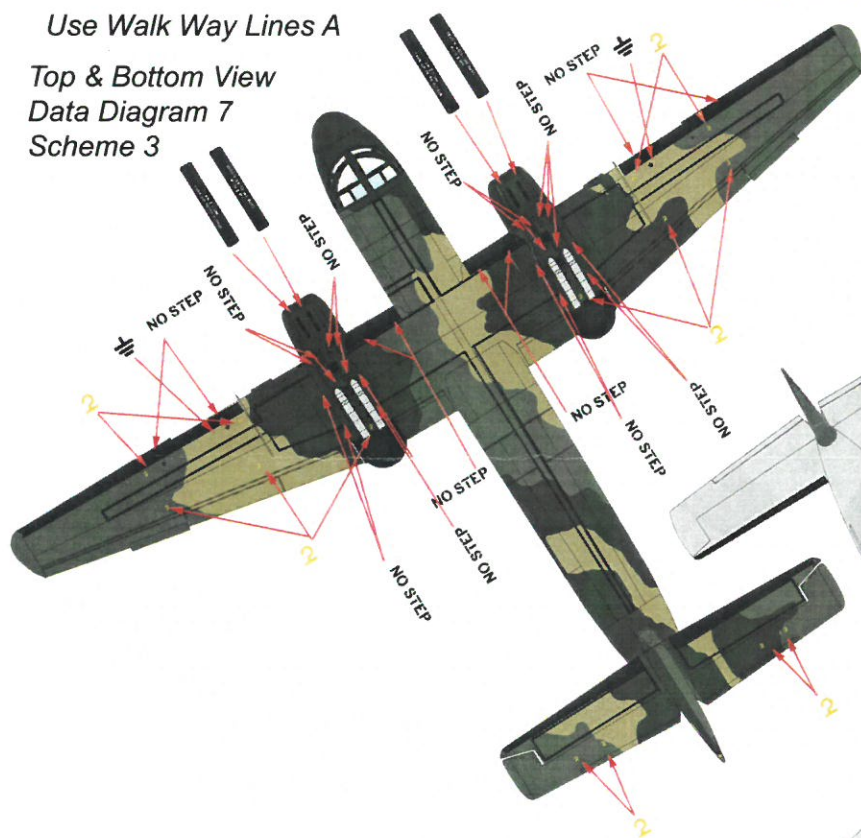

	Flat Dark Green FS-34079
	Flat Medium Green FS-34102
	Flat Dark Tan FS-30219
	Flat Light Grey FS-36375
	Matt Black FS-37038

OzMods
PO Box 5077 Alexandra Hills
QLD 4161 Australia
E mail: ozmods@bigpond.net.au
Web Site: www.ozmods-kits.com

OMKIT-14401

All Art work is copyright to OzMods and Ronin Graphics

Oz Mods





1964-2009

45 YEARS
SERVICE TO THE NATION

1964-2009

45 YEARS
SERVICE TO THE NATION

*45 Years of
Operations*



ROYAL AUSTRALIAN AIR FORCE

ROYAL AUSTRALIAN AIR FORCE

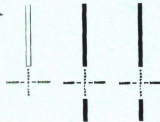

37 12 X 12

37 12 X

A4-140 A4-140 A4-140

A4-152 A4-152 A4-152

A4-210 A4-210 A4-210

A4-236 A4-236 A4-236

A4-299 A4-299 A4-299

140 140 140

152 152 152

210 210 210

236 236 236

299 299 299



AF 63

AF 63

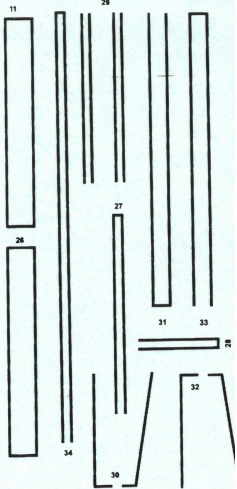
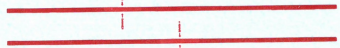

1/144 DHC-4 Caribou OZ Mods