

**48-405
Mig-29 Fulcrums
Syria, U.S.S.R., Yugoslavia
Last East German Mig, Unified Germany**

SCALE MODEL DECALS

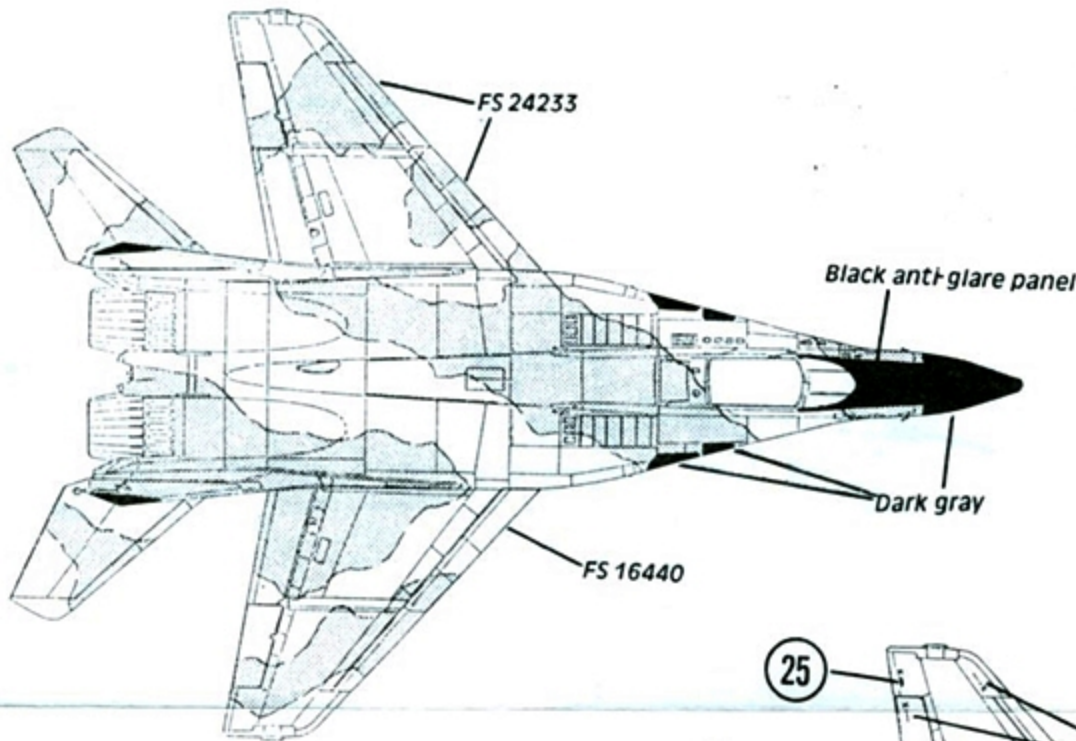

See July 1989 issue of
"Fine Scale Modeler"
For paint mixing instructions

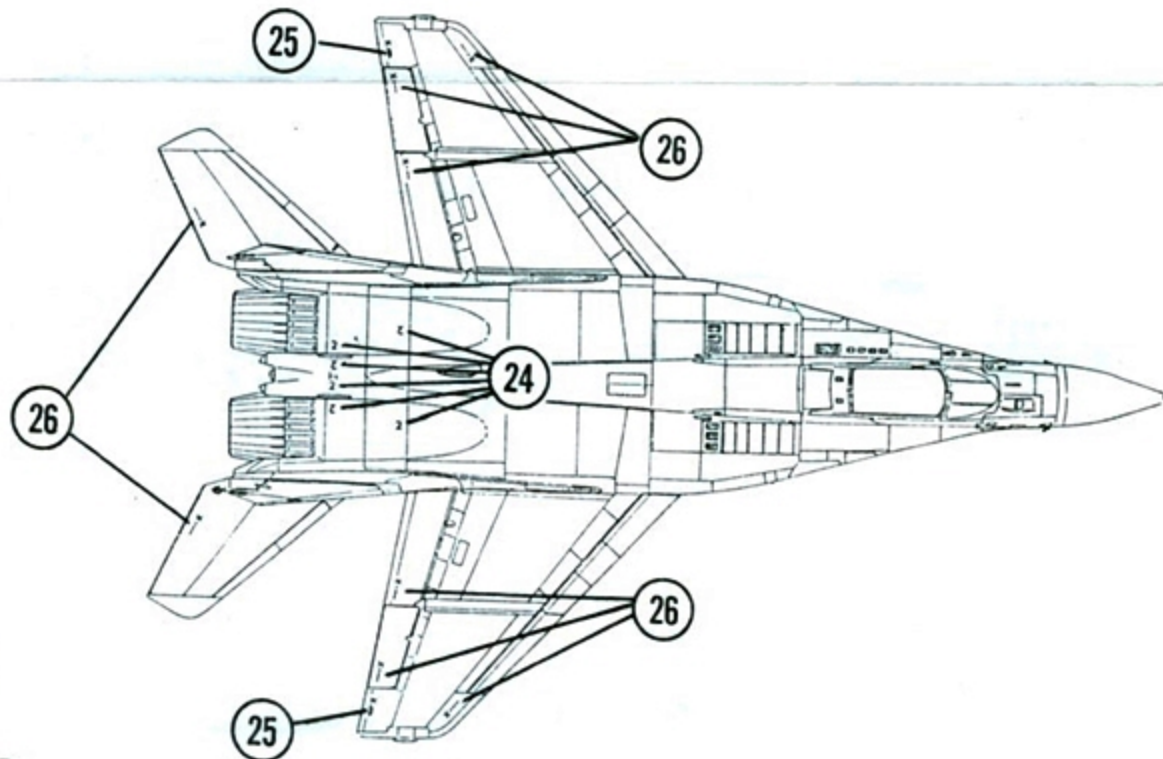

The stencil data may not be
suitable for front line Soviet,
Yugoslav, or East German Fulcrums.
It has been seen on test bureau aircraft
and non Warsaw Pact exports such as Syria,
Iraq, Iran, India and Cuba

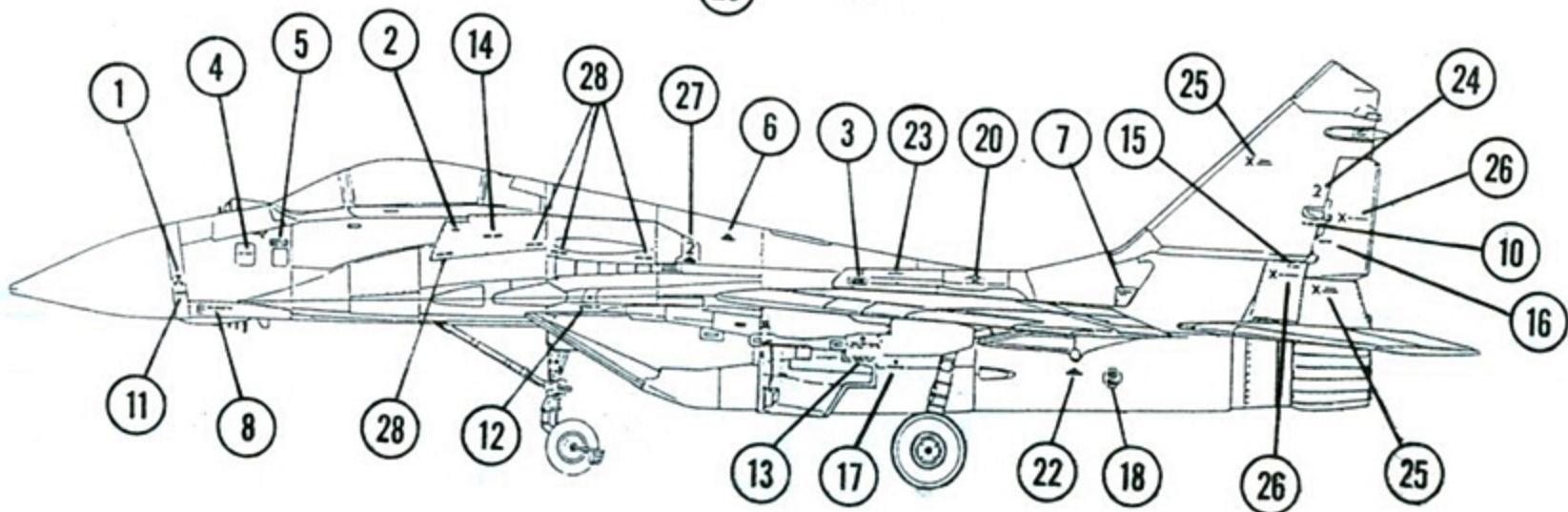

See July 1989 issue of
"Fine Scale Modeler"
For paint mixing instructions

Mig 29 of the
Syrian Air Force

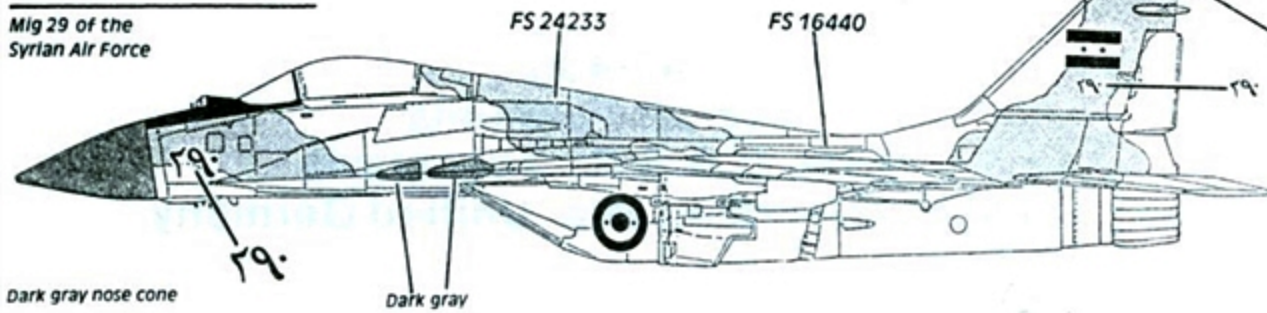

FS 24233

FS 16440

Dark gray with
black leading edge

Dark gray nose cone

Dark gray

Mig 29 in service
with the O. K. B. Test
and Design Bureau

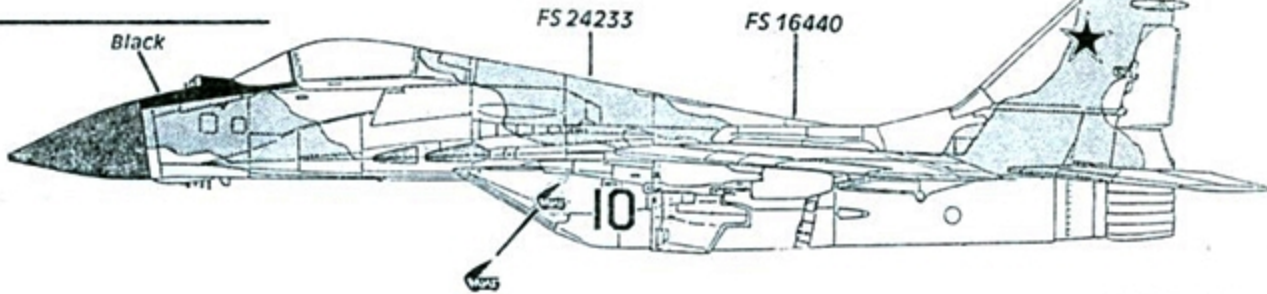

Black

FS 24233

FS 16440

10

Dark gray with
black leading edge

Mig 29 in service
with a Soviet Guards Regiment

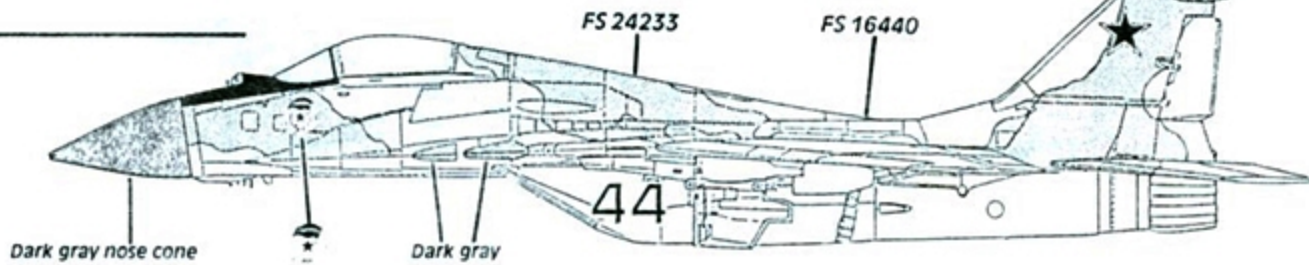

FS 24233

FS 16440

Dark gray nose cone

Dark gray

Red and yellow stripe forms
border of black anti-glare
panel

Black canopy frame

Dark gray with
black leading edge

Yellow

Red 604 participated in
the last flight of the
Mig 29 in East German
service on Sept. 27, 1990
and was specially painted
to mark the occasion

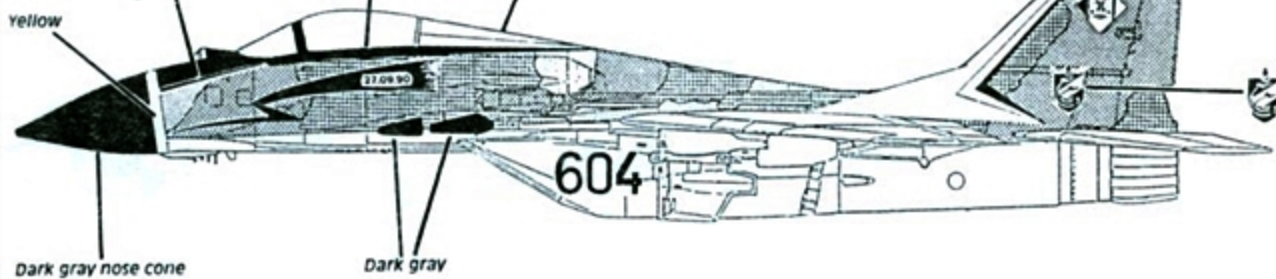

604

604

Dark Green FS 34079
Medium Green FS 34102
Dark Tan FS 30219
Dark Brown FS 30099

Entire underside FS 16440

Dark gray nose cone

Dark gray

Mig 29 of the German
Air Force (formerly known
as Red 785)

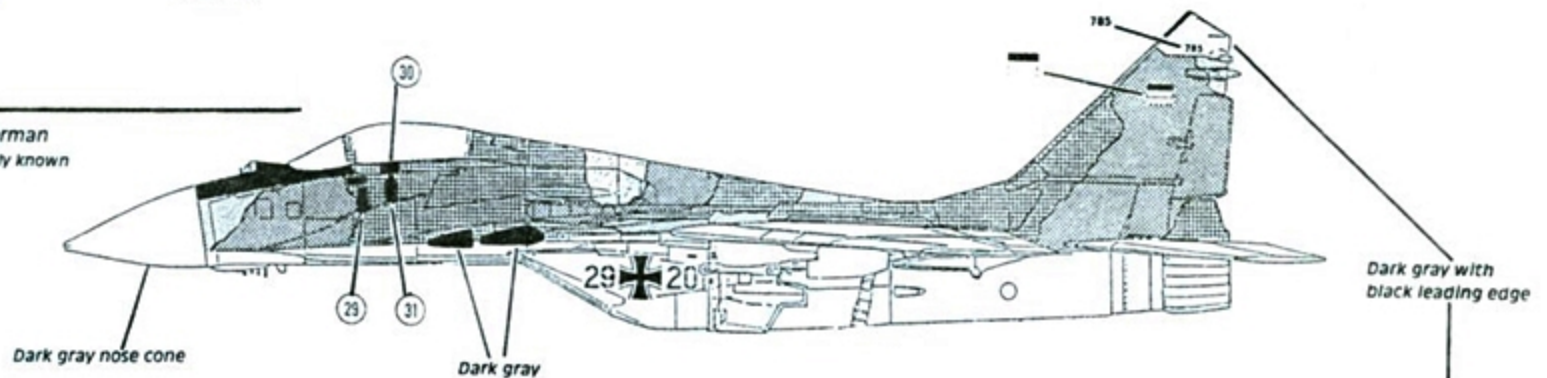

Dark gray nose cone

Dark gray

Dark gray with
black leading edge

Mig 29 of the Yugoslav
Air Force, used for both
air defence and ground attack

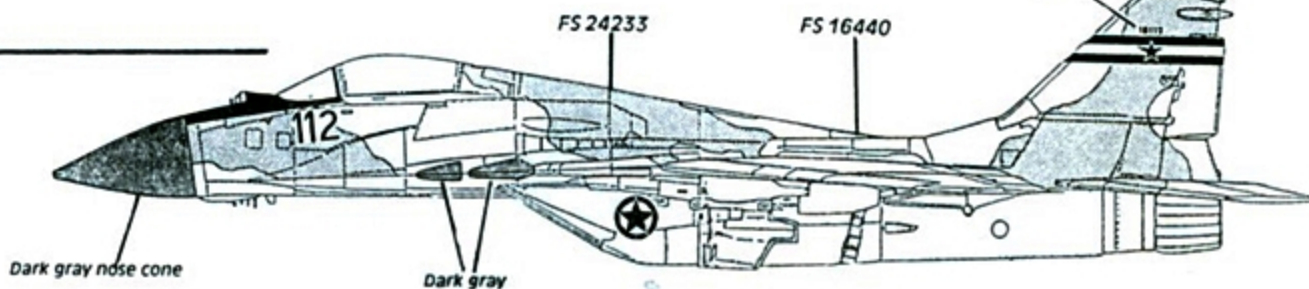

Dark gray nose cone

Dark gray

FS 24233

FS 16440