

CAPOT  
MITRAILLEUSE  
GUN FRONT  
COWLING

CAPOTAGE ANTI-REFLETS :  
OLIVE DRAB FS34087  
ANTI-DAZZLE PANNEL :  
OLIVE DRAB FS34087

BANDEAU FUSELAGE :  
ORANGE FS32190 ANA 508  
FUSEL. BAND : ORANGE  
FS32190 ANA 508

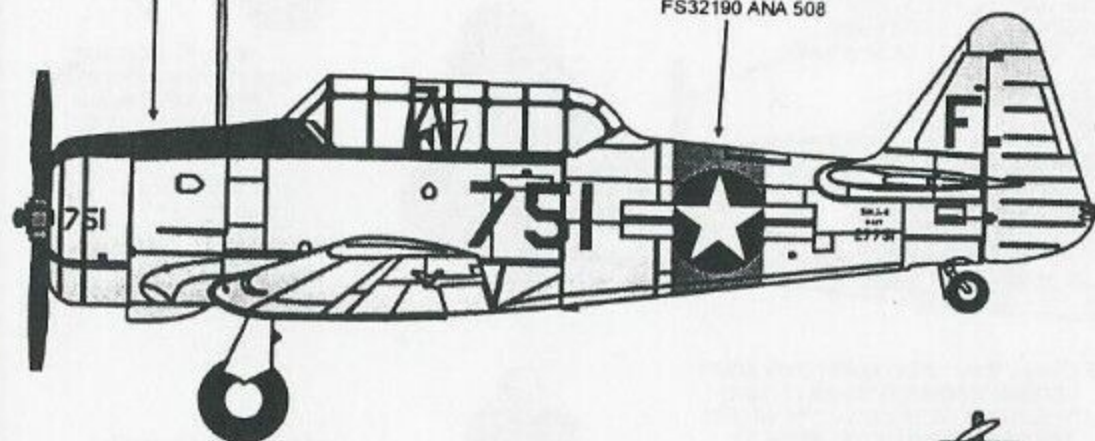

AVION ENTIEREMENT  
ARGENT MAT  
ENTIRE AIRCRAFT :  
MATT SILVER

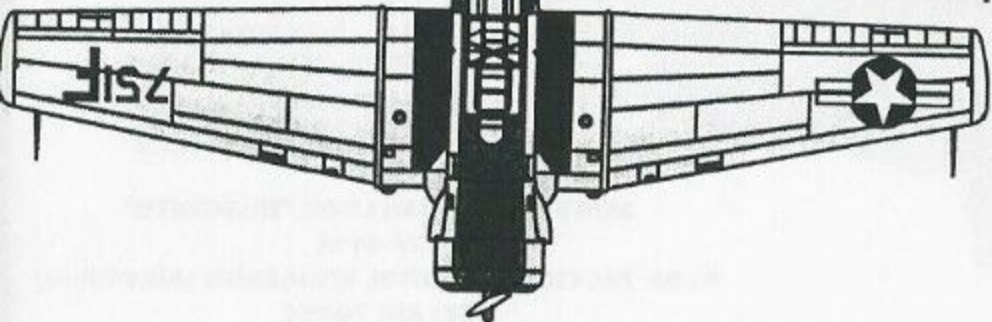
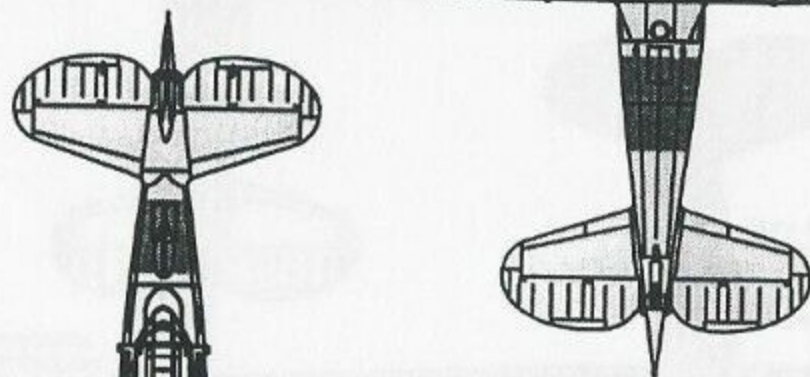
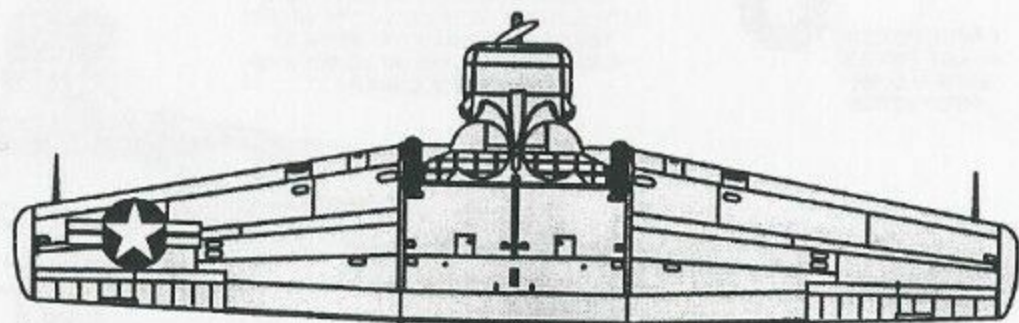

NORTH AMERICAN SNJ-4 TEXAN  
BUREAU NUMBER : BuNo 27751

OAKLAND NAVAL AIR RESERVE  
OAKLAND BAY , SAN FRANCISCO  
CALIFORNIA , MARCH 1950

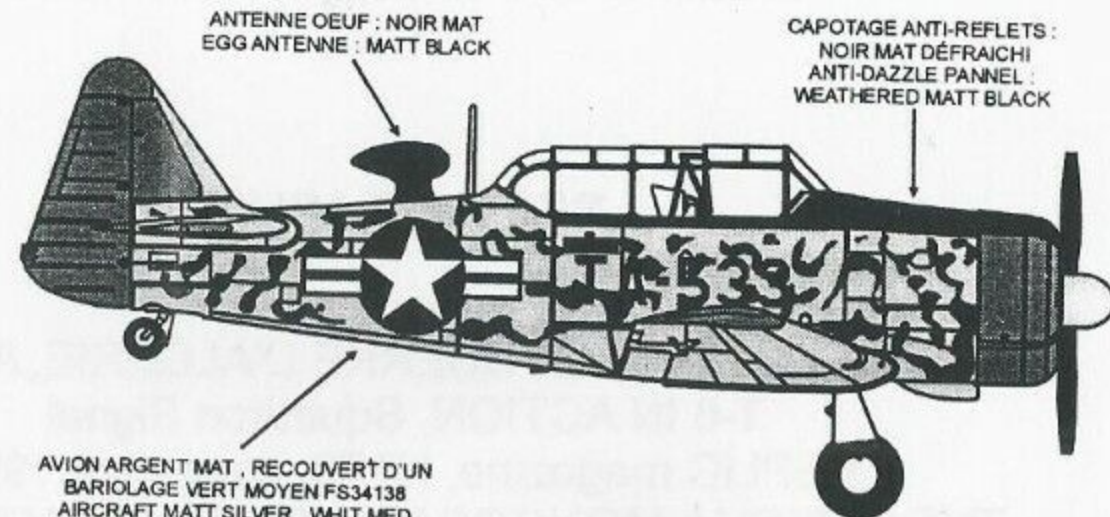

ANTENNE OEUF : NOIR MAT  
EGG ANTENNE : MATT BLACK

CAPOTAGE ANTI-REFLETS :  
NOIR MAT DÉFRAÏCHI  
ANTI-DAZZLE PANNEL :  
WEATHERED MATT BLACK

HÉLICE NOIR MAT ,  
BOUTS JEUNE  
PROP TIPS MATT BLACK ,  
YELLOW TIPS

AVION ARGENT MAT , RECOUVERT D'UN  
BARIOLAGE VERT MOYEN FS34138  
AIRCRAFT MATT SILVER , WHIT MED  
GREEN ( ANA 630 ) MOTTLED CAMO

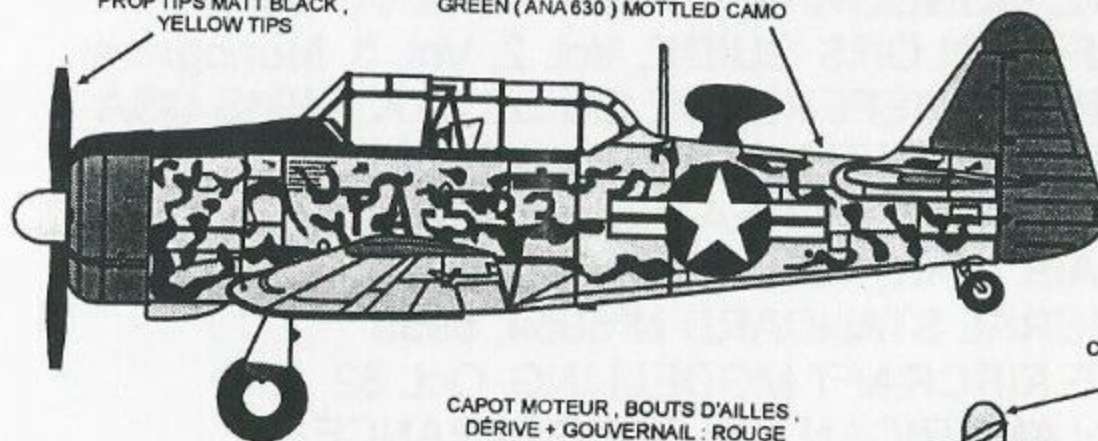

CAPOT MOTEUR , BOUTS D'AILLES ,  
DÉRIVE + GOUVERNAIL : ROUGE  
ENGINE COWL , WINGS TIPS ,  
FIN AND RUDER : FS31136

CASSEROLE D'HELICE :  
METAL POLI  
PROP SPINNER :  
POLISHED METAL

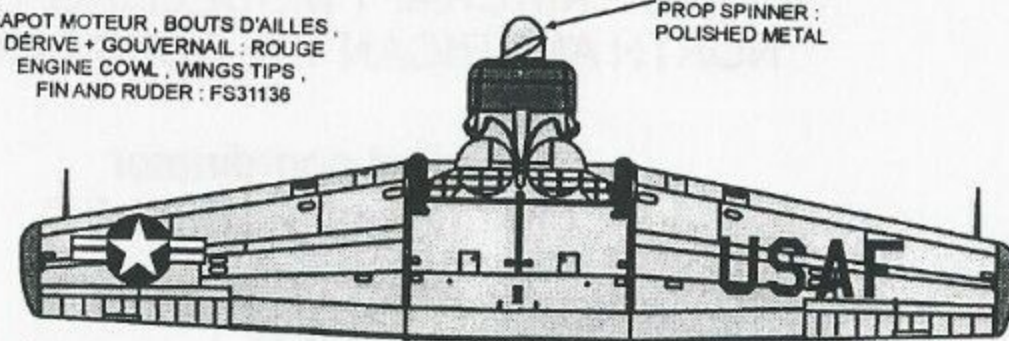

SURFACES INFÉRIEURES :  
ARGENT MAT  
UNDERSURFACES :  
MATT SILVER

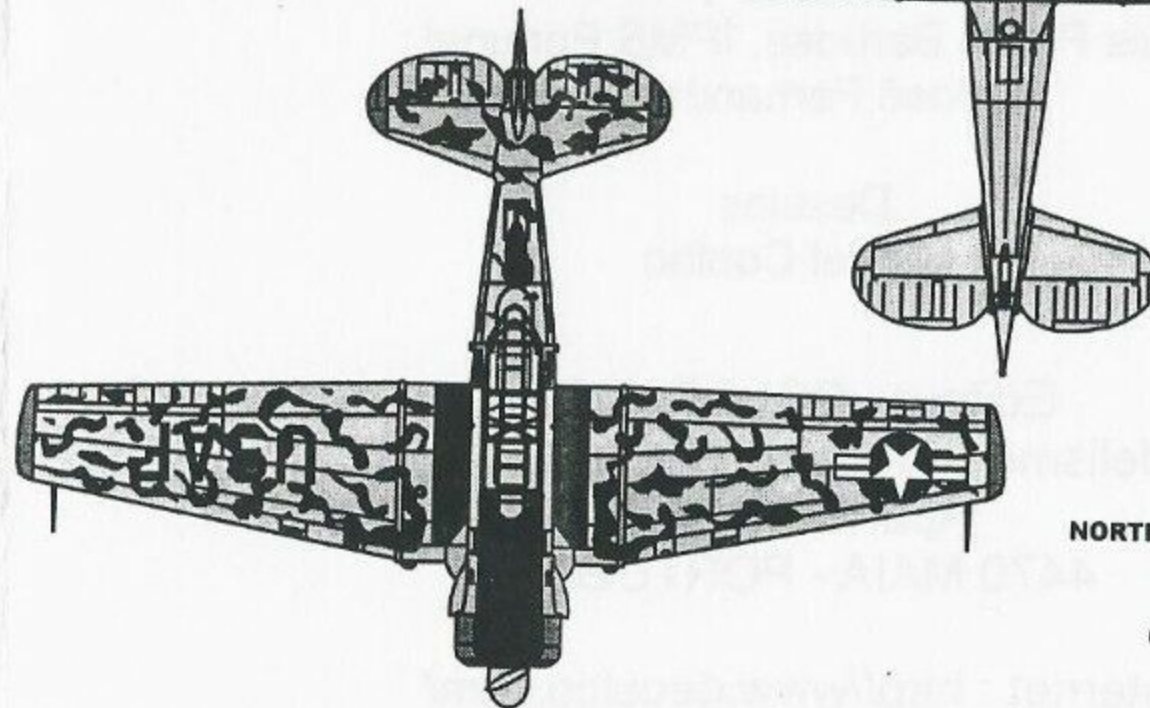

NORTH AMERICAN AT-6G TEXAN  
SERIAL N° 49-3533

6147 TC AQUADRON  
5 AIR FORCE  
TAEGU , KOREA

U. S. AIR FORCE  
SEPTEMBRE 1951

AVION METAL NATUREL  
 ASSEZ PROPRE ET POLI , AVION NEUF  
 CLEAN AND POLISHED METAL  
 AIRCRAFT , BRAND NEW AIRCRAFT

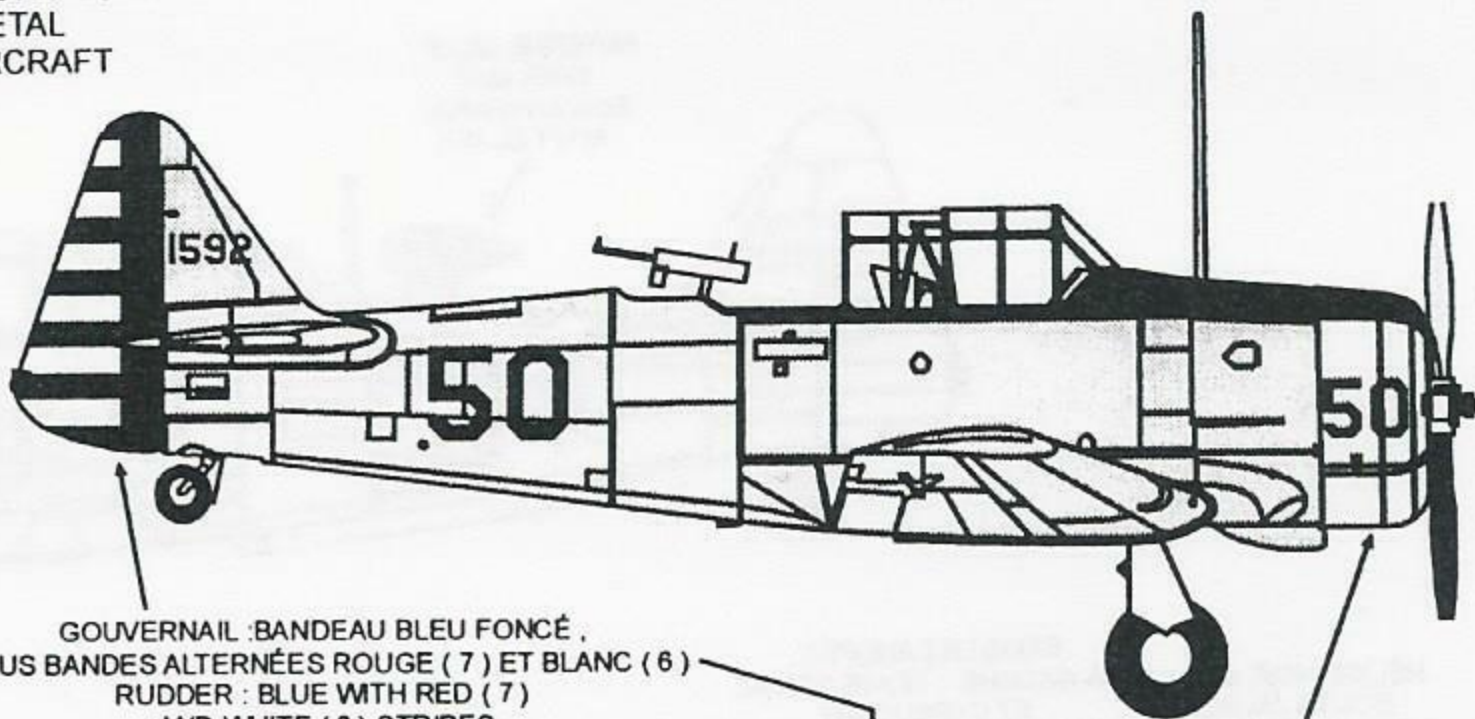

CAPOTAGE ANTI-REFLETS :  
 NOIR MAT DÉFRAICHI  
 ANTI-DAZZLE PANNEL :  
 WEATHERED MATT BLACK

GOUVERNAIL : BANDEAU BLEU FONCÉ ,  
 PLUS BANDES ALTERNÉES ROUGE ( 7 ) ET BLANC ( 6 )  
 RUDDER : BLUE WITH RED ( 7 )  
 AND WHITE ( 6 ) STRIPES

CAPOT MOTEUR  
 JEUNE FS33538 ( ANA 614 )  
 ENGINE COWL :  
 YELLOW FS33534 ( ANA 614 )

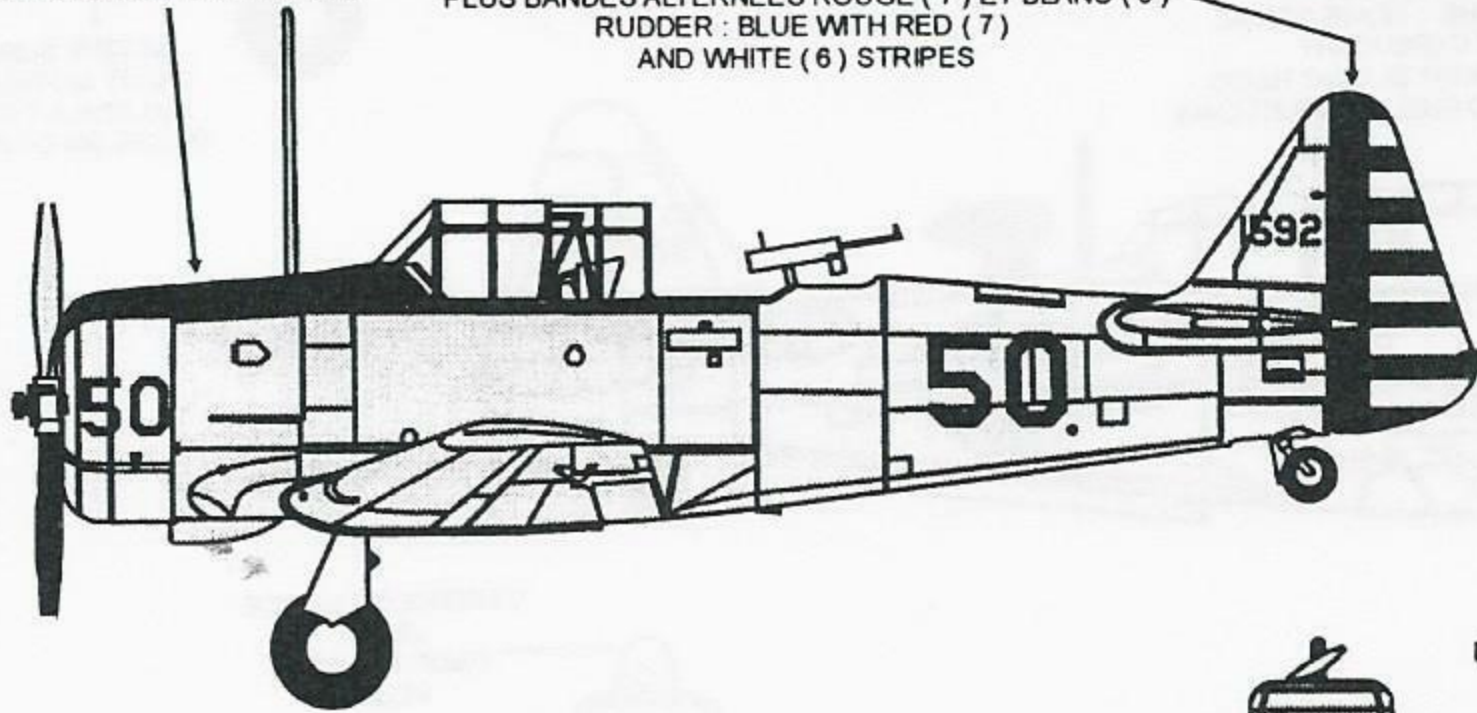

PAS DE CASSEROLE  
 D'HÉLICE  
 NO PROP  
 SPINNER

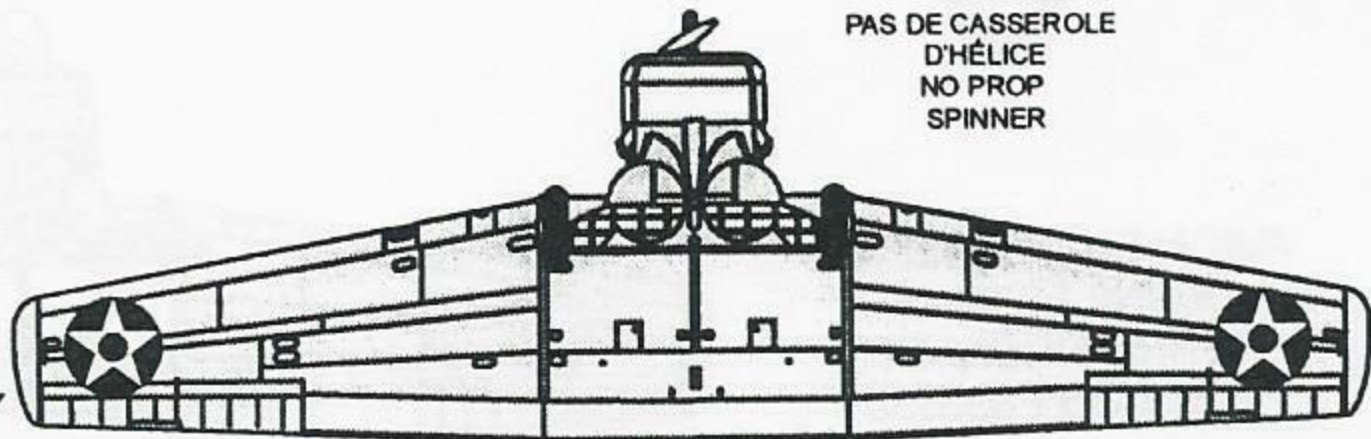

COCARDES AUX 4 POSITIONS  
 USUELLES D'AILES  
 INSIGNIAS ON 4 USUAL  
 WING POSITIONS

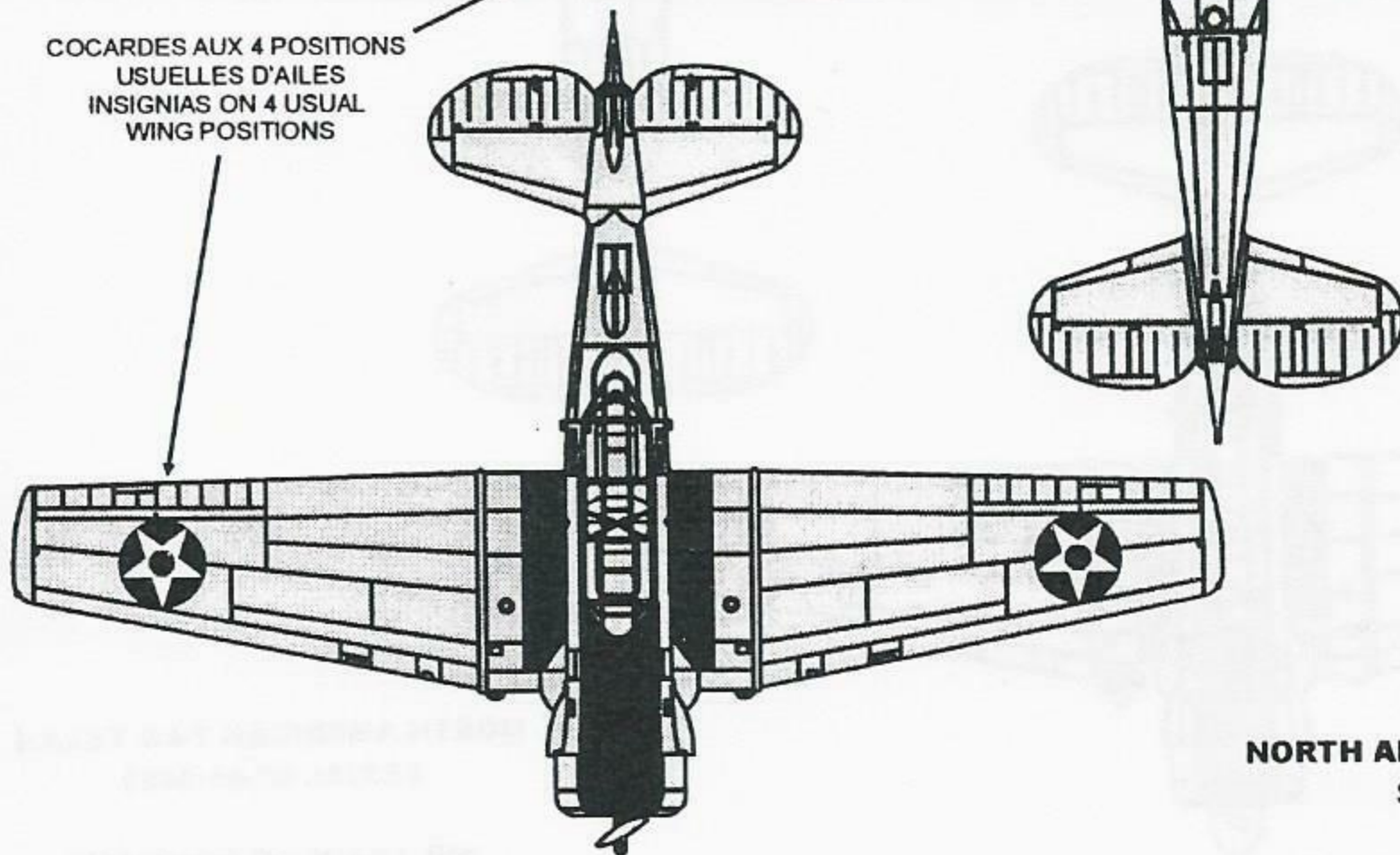

**NORTH AMERICAN AT-6A-NT TEXAN  
 SERIAL N° 41-592**

**HARLINGEN GUNNERY SCHOOL  
 HARLINGEN ARMY AIR BASE  
 TEXAS , 1942**

ANTENNE OEUF :  
NOIR MAT  
EGG ANTENNA :  
MATT BLACK

CAPOT ANTI-REFLETS :  
NOIR MAT  
ANTI-DAZZLE PANNEL :  
MATT BLACK

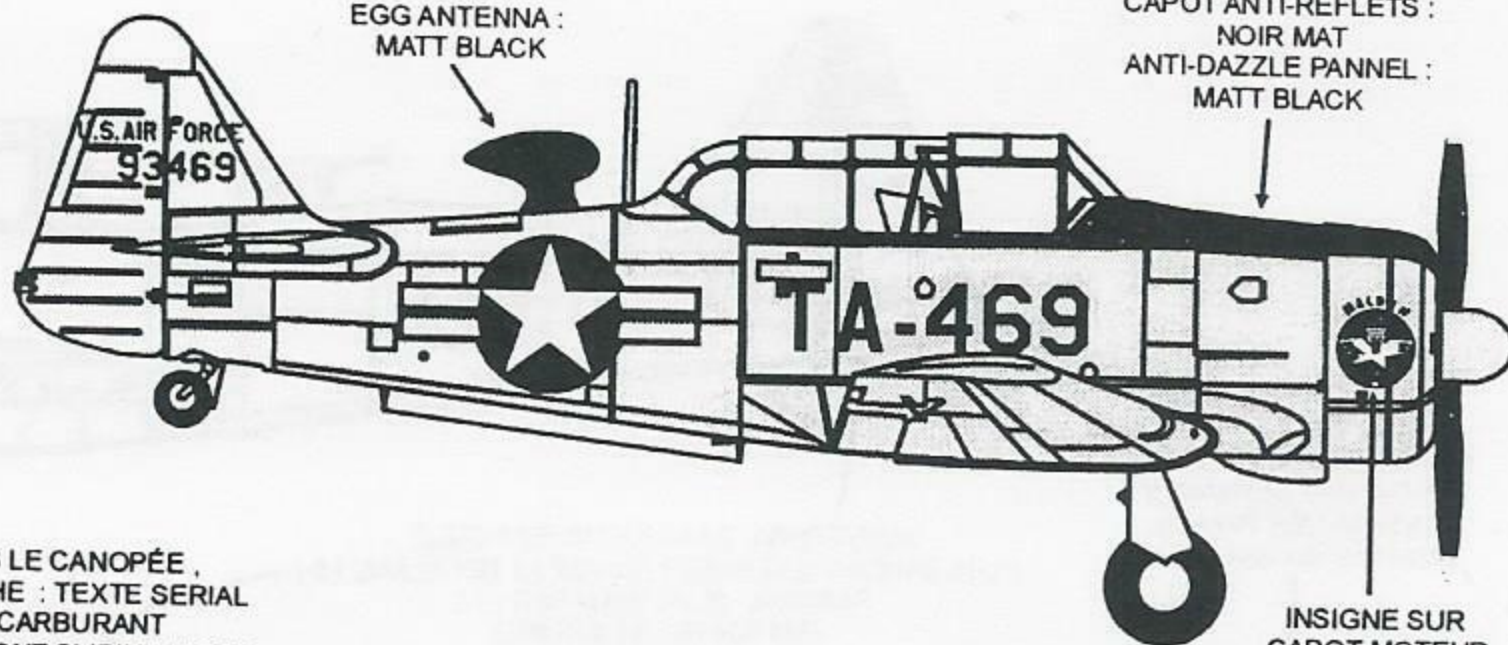

HÉLICE NOIR MAT,  
BOUTS JAUNE  
PROP MATT BLACK,  
YELLOW TIPS

SOUS LE CANOPÉE,  
À GAUCHE : TEXTE SERIAL  
ET CARBURANT  
UNDER FRONT SLIDING HOOD :  
SERIAL AND FUEL INSTRUCTIONS

INSIGNE SUR  
CAPOT MOTEUR  
MALDEN A.T.C.  
BADGE ON COWL

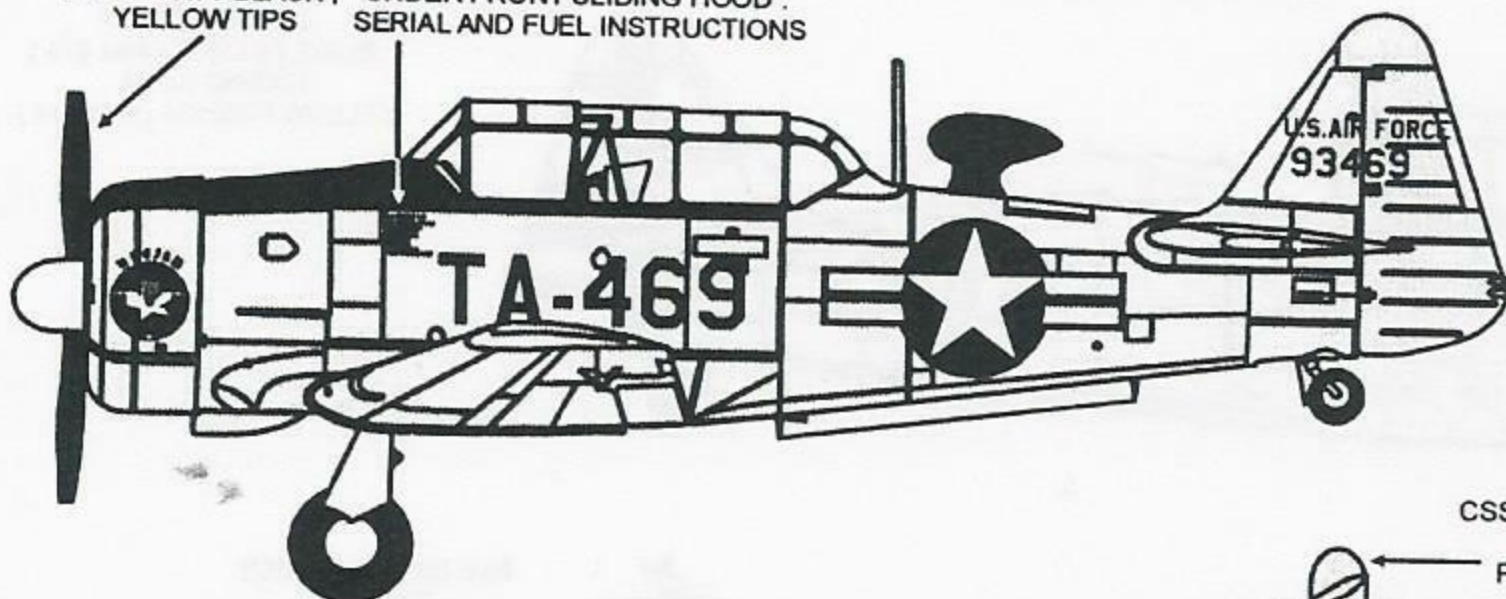

CSSEROLE D'HÉLICE :  
JEUNE  
PROP SPINNER :  
YELLOW

AVION ENTIÈREMENT  
JEUNE FS33538  
ENTIRE AIRCRAFT :  
YELLOW FS33538

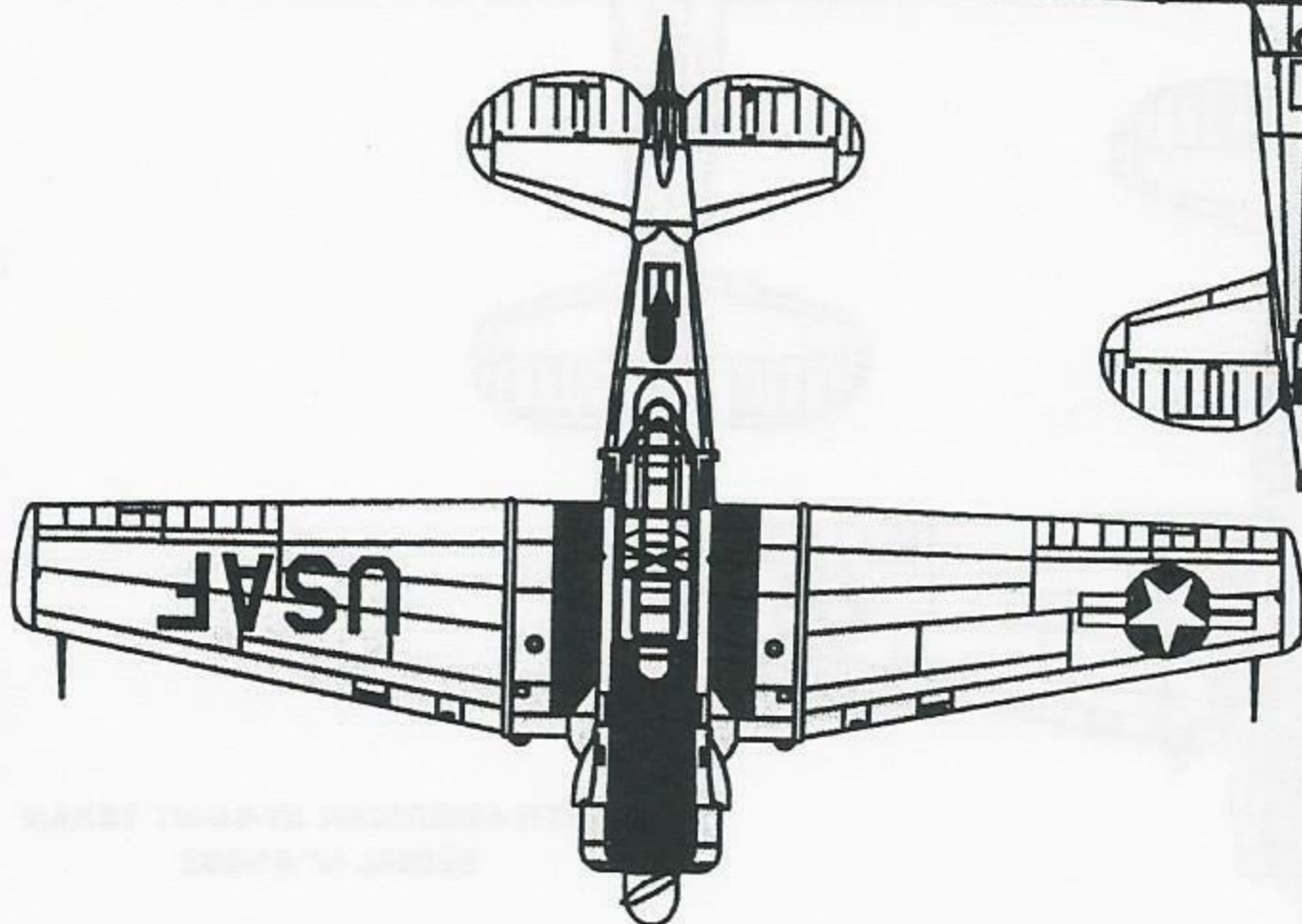
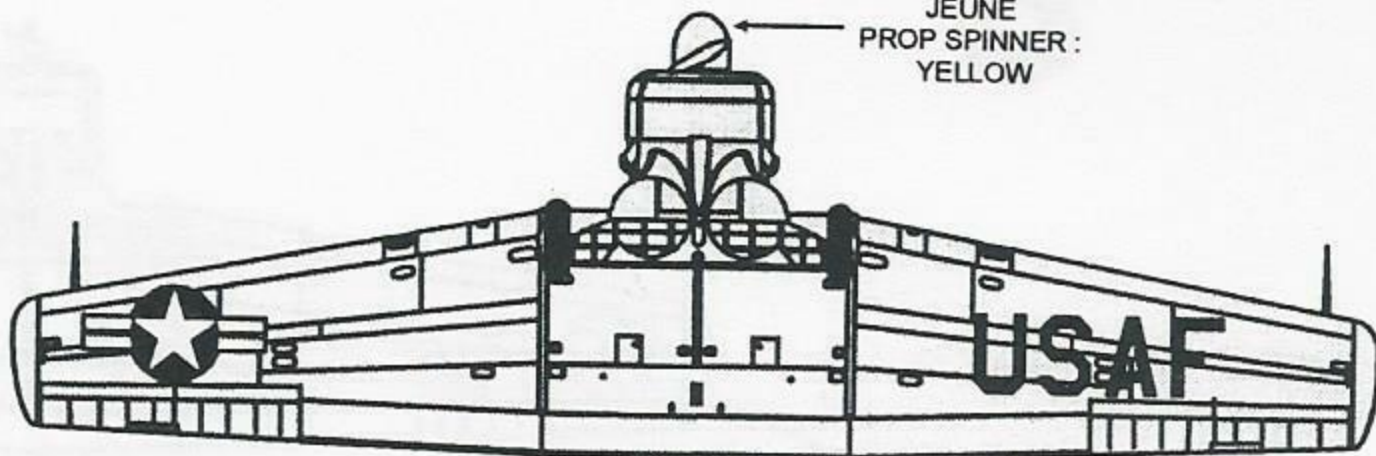

**NORTH AMERICAN T-6G TEXAN  
SERIAL N° 49-3469**

**AIR TRAINING COMMAND  
MALDEN AIR FORCE BASE**

**U.S. AIR FORCE 1953**