



# AAVP-7A1 exterior

1/35 scale detail set for HOBBY BOSS kit • sada detailů pro model 1/35 HOBBY BOSS

eduard

36 079

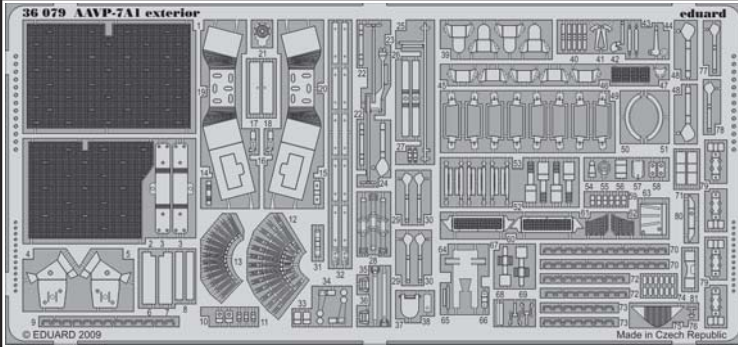

film

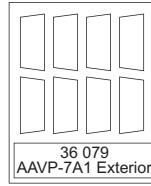

- APPLY EXPRESS MASK AND PAINT BEFORE GLUING  
POUŽIT EXPRESS MASK NABARVIT PŘED SLEPENÍM
- SYMMETRICAL ASSEMBLY  
SYMETRICKÁ MONTÁŽ
- REMOVE  
ODSTRANIT
- GRIND  
OBROUSIT
- DRILL HOLE  
VRTAT OTVOR
- BEND  
OHNOUT
- OPTION  
VOLBA
- REPLACE  
NAHRADIT

ORIGINAL KIT PARTS  
PŮVODNÍ DÍLY STAVEBNICE

PHOTO-ETCHED PARTS  
LEPTANÉ DÍLY

PARTS TO BE REMOVED  
DÍLY K ODSTRANĚNÍ

FILL  
TMELIT

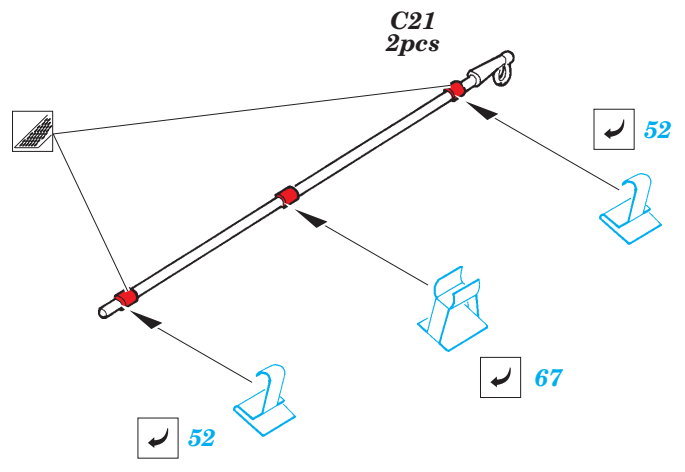
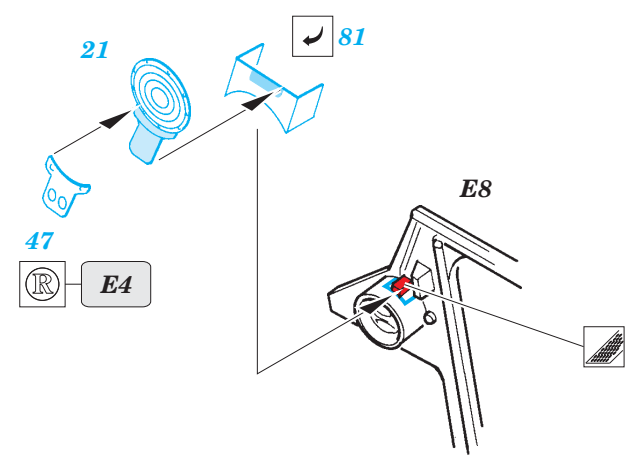
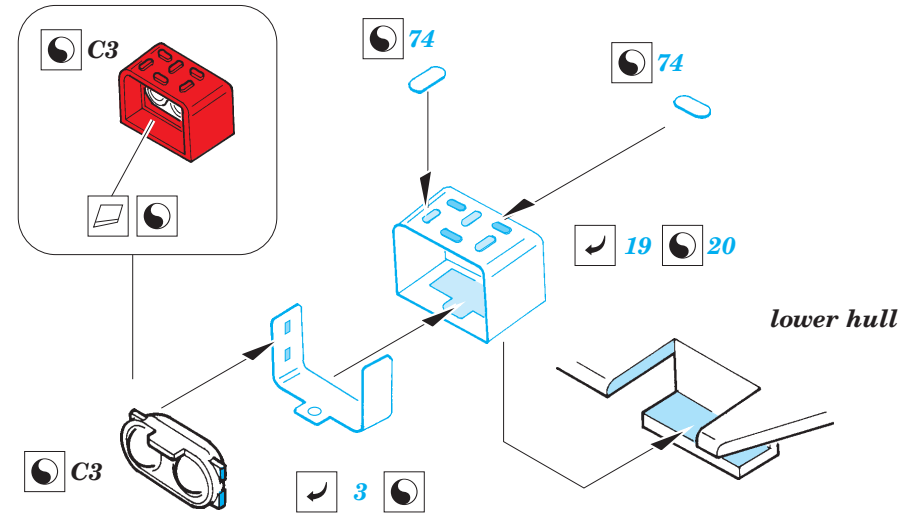
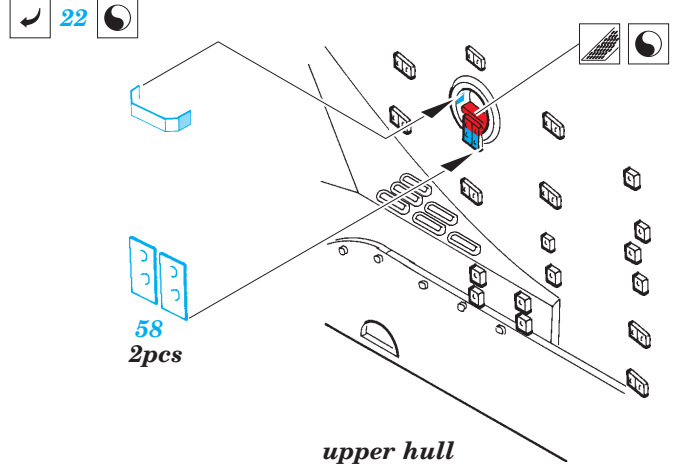
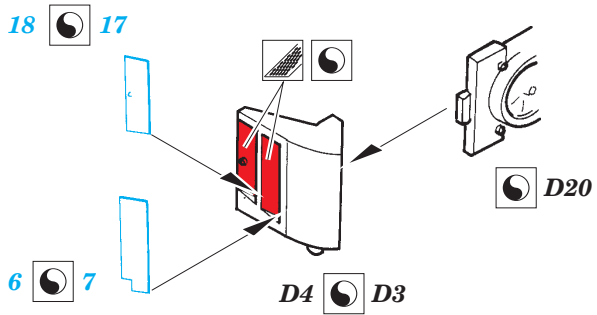

1 (R) PE-A9

2 (R) PE-A11

45

75

76

39

32

10

33

48  
2 pcs

upper hull

(R) PE-A8

60

(R) PE-A7

60

D8

upper hull

D28

31

(R) PE-A12

46

D7

39

45

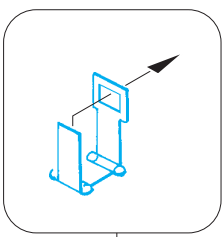

D15

14

28

40

C43

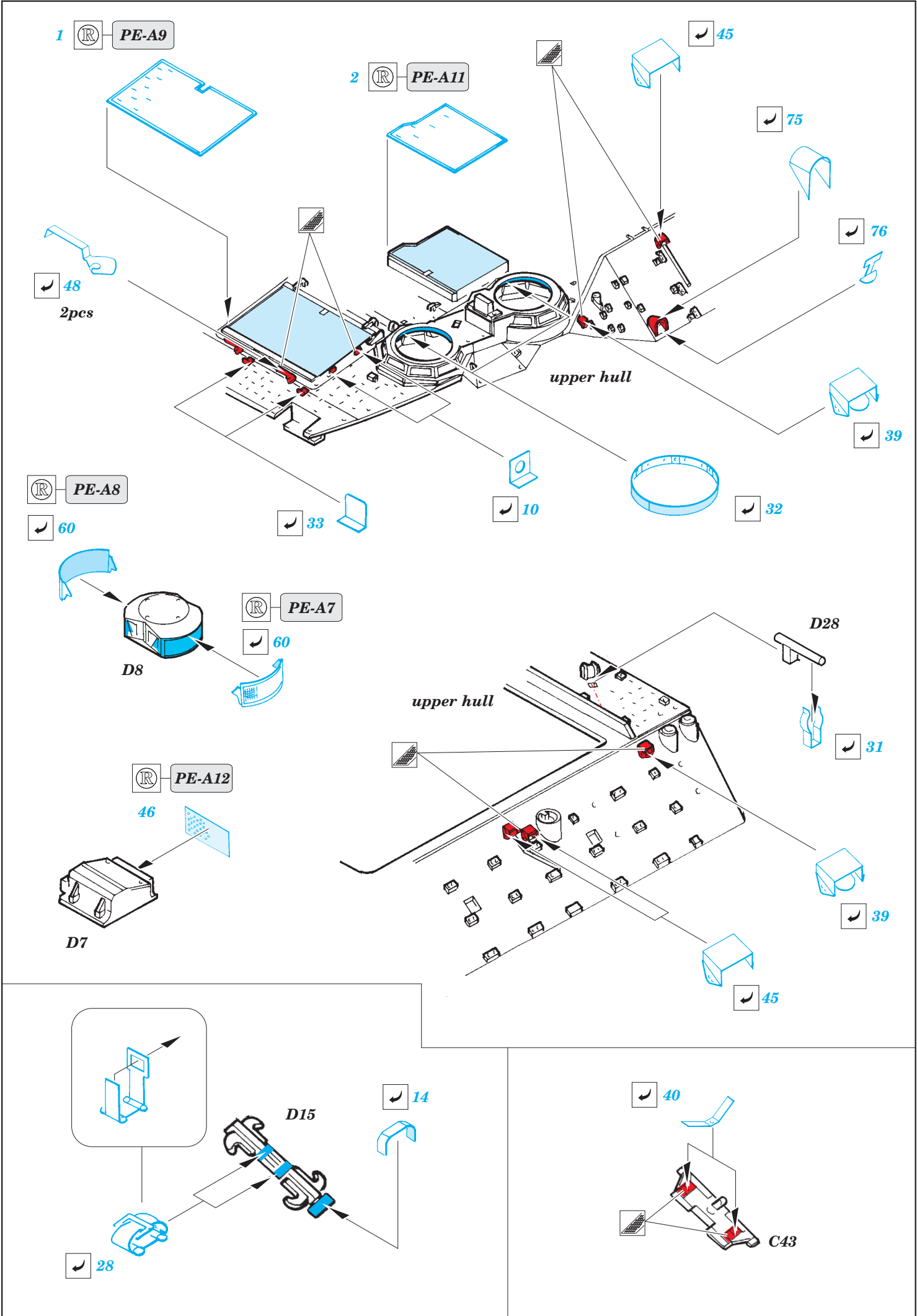

fill

plastic

plastic

26

26

D33

new position

39

upper hull

45

plastic

80

39

Q16

78

77

C33

Q16

79

Q6 Q7

53

35

Q6

upper hull

53

30

C33

29

59

Q7

