

AeroMaster



Aces of the Eighth Pt. III



3615 NW 20th Ave • Miami, Florida 33142 • USA
Tel. (305) 635-3134 • Fax (305) 638-4197

Note: Parenthesis indicates opposite or starboard placement
"xx+xx" indicates applying one decal over another for purposes of better registration.

A/C # 1: P-51D-15-NA
4415625 flown by Col.
Clairborne Kinnard Jr.,
355th FG, early 1945.
Overall duraluminum finish
with white spinner. Red
nose band and rudder.
Weathered black anti-glare
panel. Twin rear view
mirrors, painted black.

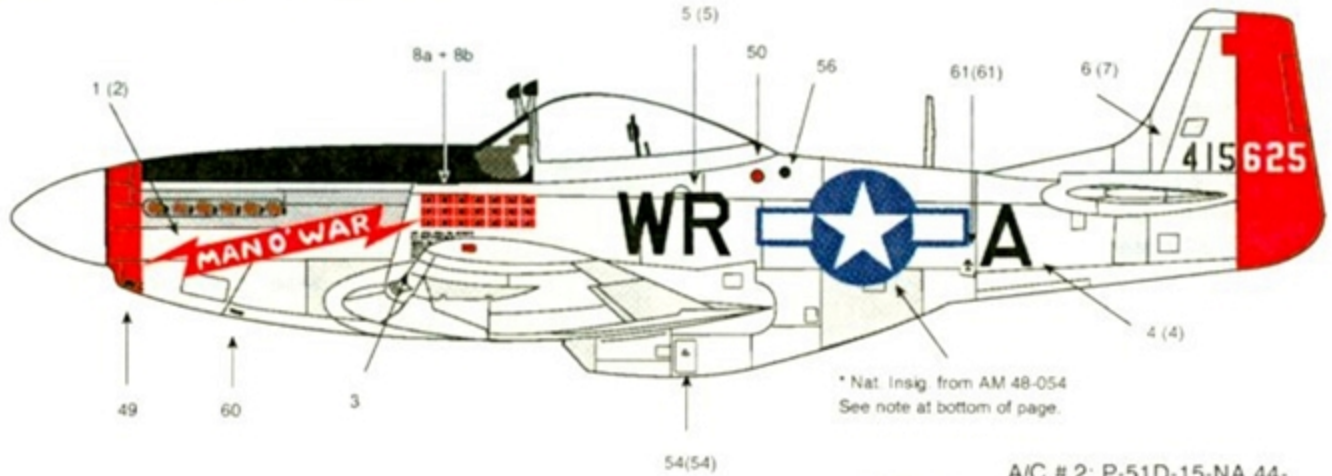

* Nat. Insig. from AM 48-054
See note at bottom of page.

A/C # 2: P-51D-15-NA 44-
73144 flown by Col.
Clairborne Kinnard Jr., 355th
FG, April/May 1945. Overall
duraluminum finish with white
spinner and forward nose.
Weathered black anti-glare
panel. Two rear view mirrors
painted black. A/C data block
(decal 18) has been provided
even though references
appear to show its removal by
this point in time.

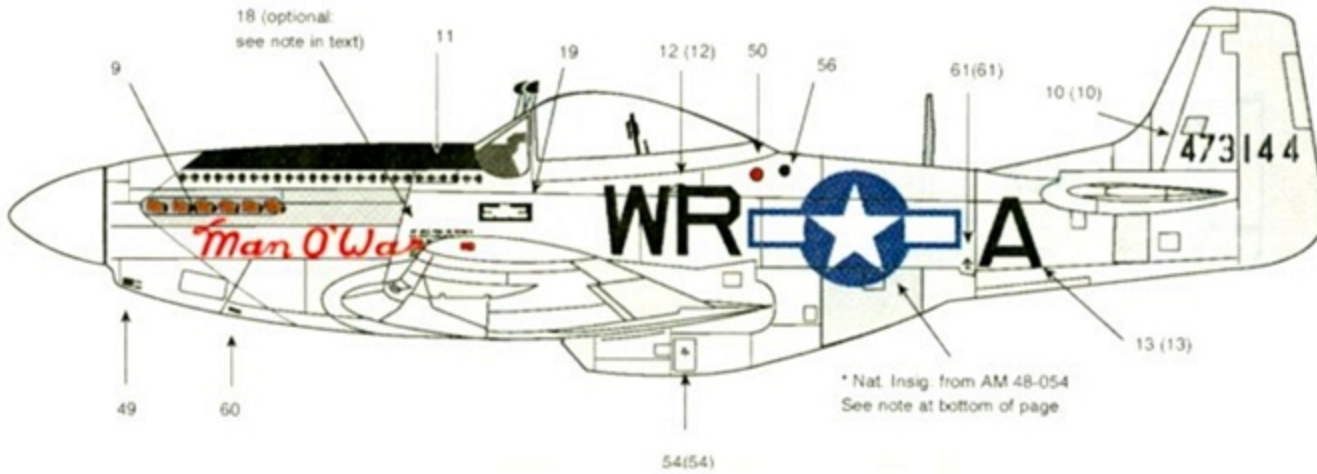

* Nat. Insig. from AM 48-054
See note at bottom of page.

A/C # 3: P-51D-15-NA 44-
15255, flown by First Lt. Col.
Gordon Graham, 354th FS,
355th FG, March/April 1945.
Overall duraluminum finish
with white spinner, forward
nose, and lower forward
fuselage. Red rudder and
med. green anti-glare panel.
A/C data block (decal 17)
has been provided even though
references appear to show its
removal by this point in time.
Note: Nose must
be painted before decaling.

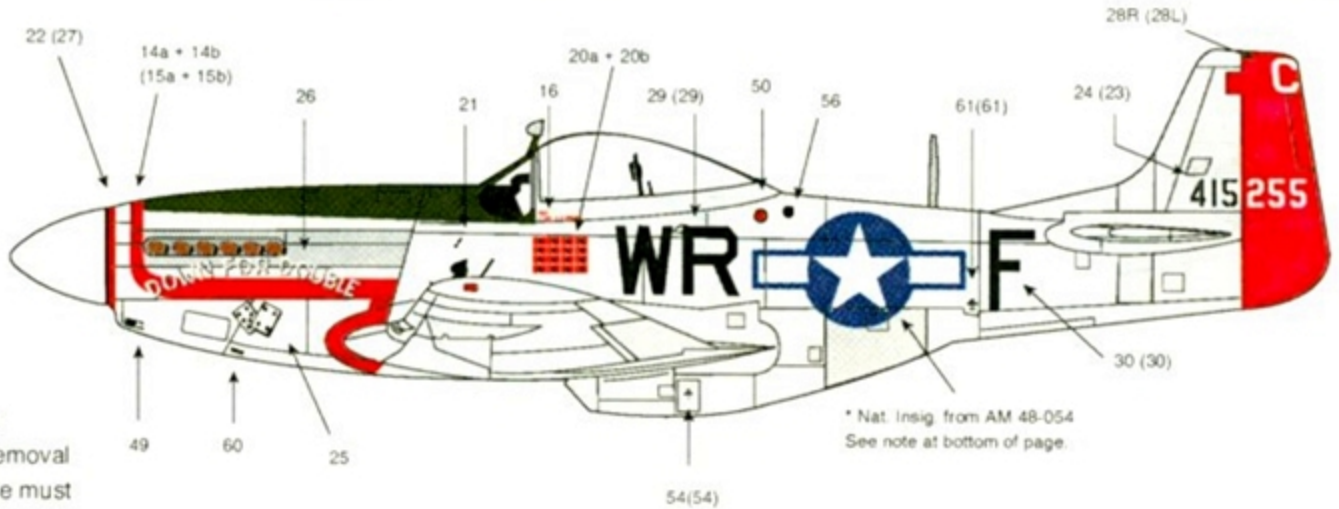

* Nat. Insig. from AM 48-054
See note at bottom of page.

A/C # 4: P-51D-25-NA 44-
73108, flown by Maj.
William Hovde, 358th FS,
355nd FG, December
1944. Overall duraluminum
finish with white spinner.
Yellow nose band and
rudder. Olive drab anti-
glare panel. A/C data block
(decal 31) has been
provided even though
references appear to show
its removal by this point in time.
Note the
greyed out star and bars of the national insignia
(decals 62).

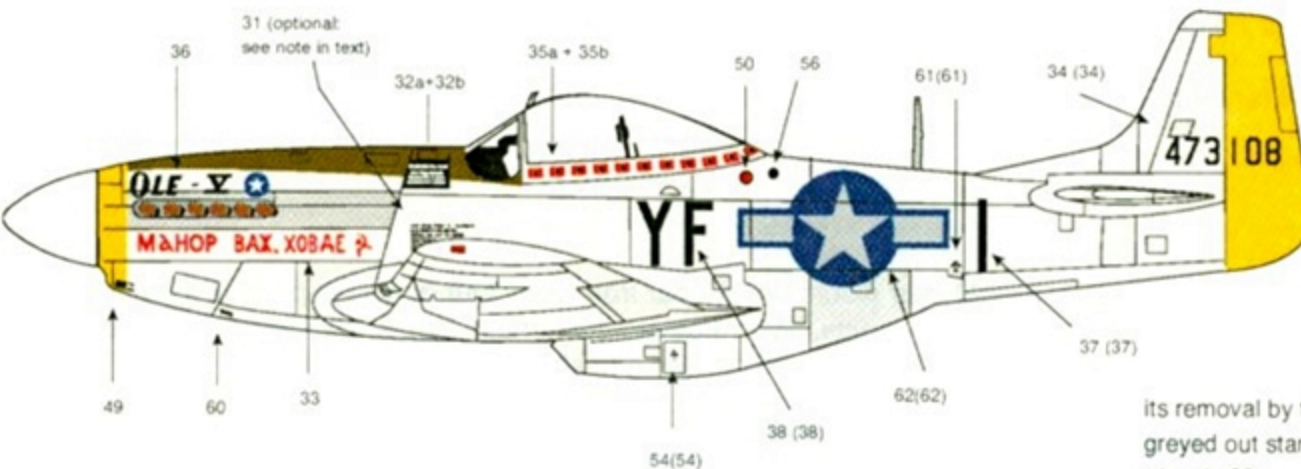

AeroMaster Decals™

A/C # 5: P-51B-10-NA 43-6928
 flown by First Lt. William Hovde,
 358th FS, 355nd FG, March/April
 1944. Olive Drab over Neutral Grey
 with white spinner and nose band.
 White theater bands on main wings
 and vertical tail. A/C data block
 (decal47) is optional. References
 show decal 40 instead.

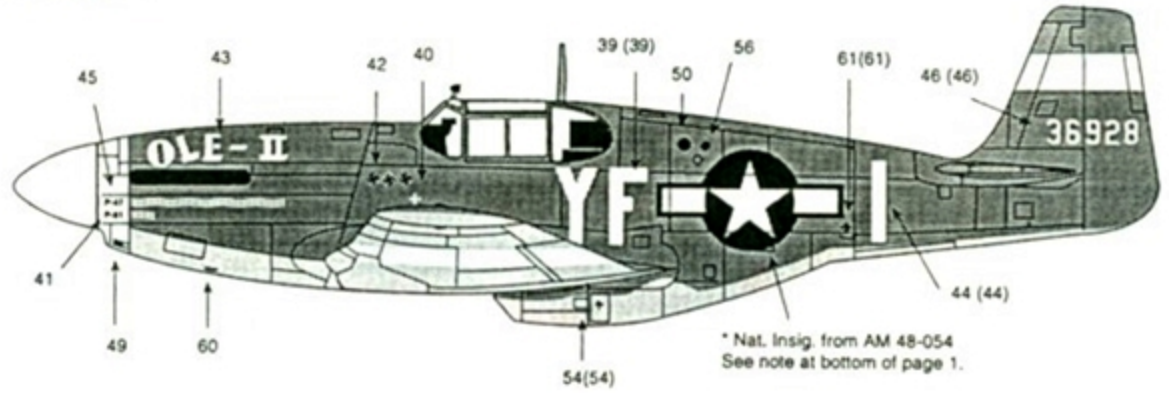

P-51B

Use AM decal sheet 48-054

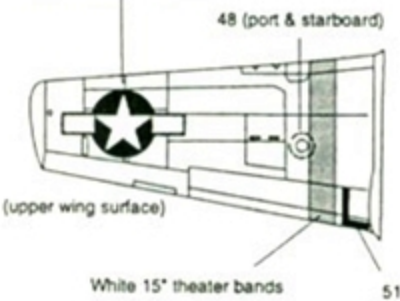

Use AM decal sheet 48-054

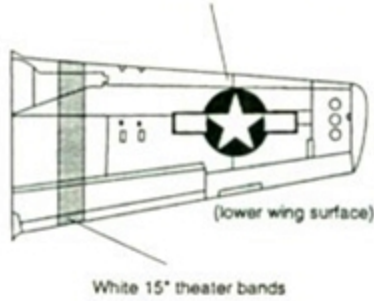

Propeller (front view)

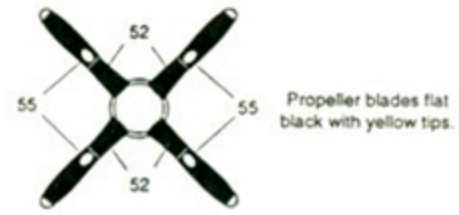

P-51D/K

a/c # 4: 48 (upper left wing only)
 a/c # 1, 2, 3: use AM decal sheet 48-054



a/c # 4: 48 (lower right wing only)
 a/c # 1, 2, 3: use AM decal sheet 48-054



We recommend **AeroMaster Warbird Colors**
 to compliment your high quality **AMD** decals

Colors required to complete the aircraft
 depicted on this decal sheet.

9001 Black	9010 Tire Black
9002 White	9040 US Olive Drab 41
9003 Yellow	9041 US Olive Drab 41 Faded
9005 Red	9042 US Green 42
9004 Blue	9043 US Neutral Grey 43

References:

1. *Mustang Aces of the Eighth Air Force*, by Jerry Scutts, Osprey Aircraft of the Aces • 1, 1994.
2. *Killer Aces, V1*, Challenge Military Publications, 1989.

Suggested Kits:

Hasegawa P-51D/K
 AeroMaster P-51B conversion #608
 (for Accurate Miniature P-51A kit #3402)

If you have suggestions for future subject matter, AeroMaster would like to hear from you. Our goal is to provide high quality, well researched decals of unusual and interesting subjects. We value our customers' inputs, so if you have specific suggestions or photographs of unusual subject matter which you would be willing to share, please contact:

AeroMaster Decals™

3615 NW 20th Ave • Miami, Florida 33142 • USA

48-131