

1/35 MILITARY MINIATURE VEHICLE UPGRADE SERIES PE35269

WWII German Aufklärungspanzer 38(t) mit 75mm Kw.K

二战德军38(t) 75mm重火力侦查坦克改造件

[For DRAGON 6310]

推荐使用工具 RECOMMENDED TOOLS

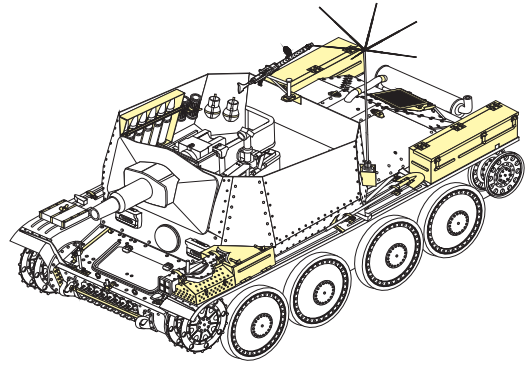
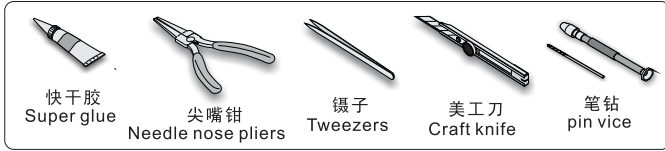

安装 install	折叠 bend	A1 改造件零件编号 PE/resin part number	B12 原零件编号 kit part number	C22 被替换的原零件编号 replaced kit part number	选择安装 alternative
切除 remove	打磨 grind off	弧度卷曲 radial bending	x2 制作若干组 multiple assembly	另一侧相同制作 repeat on opposite side	钻孔 drill
用胶棒制作 make from plastic rod					

用尖端在凹槽处冲压
use penpoint to press on the dent

蚀刻片零件内侧面向上
PE part inboard side turn up

用笔尖在凹槽处划
Use penpoint scratch on the flute

圆珠笔
Ballpen

a x2

b x2

c

d

e WC 5 x2

f x2

g x2

金属件
Metal part

金属件
Metal part

推荐使用VBS0309二战德军75mm L24炮弹进一步升级
We suggest use VBS0309 WWII German L24mm Ammunition for further upgrade.

推荐使用VBS0310二战德军75mm L24炮弹弹壳进一步升级
We suggest use VBS0310 WWII German L24mm Shell Case for further upgrade.

1/35 MILITARY MINIATURE VEHICLE UPGRADE SERIES PE35269

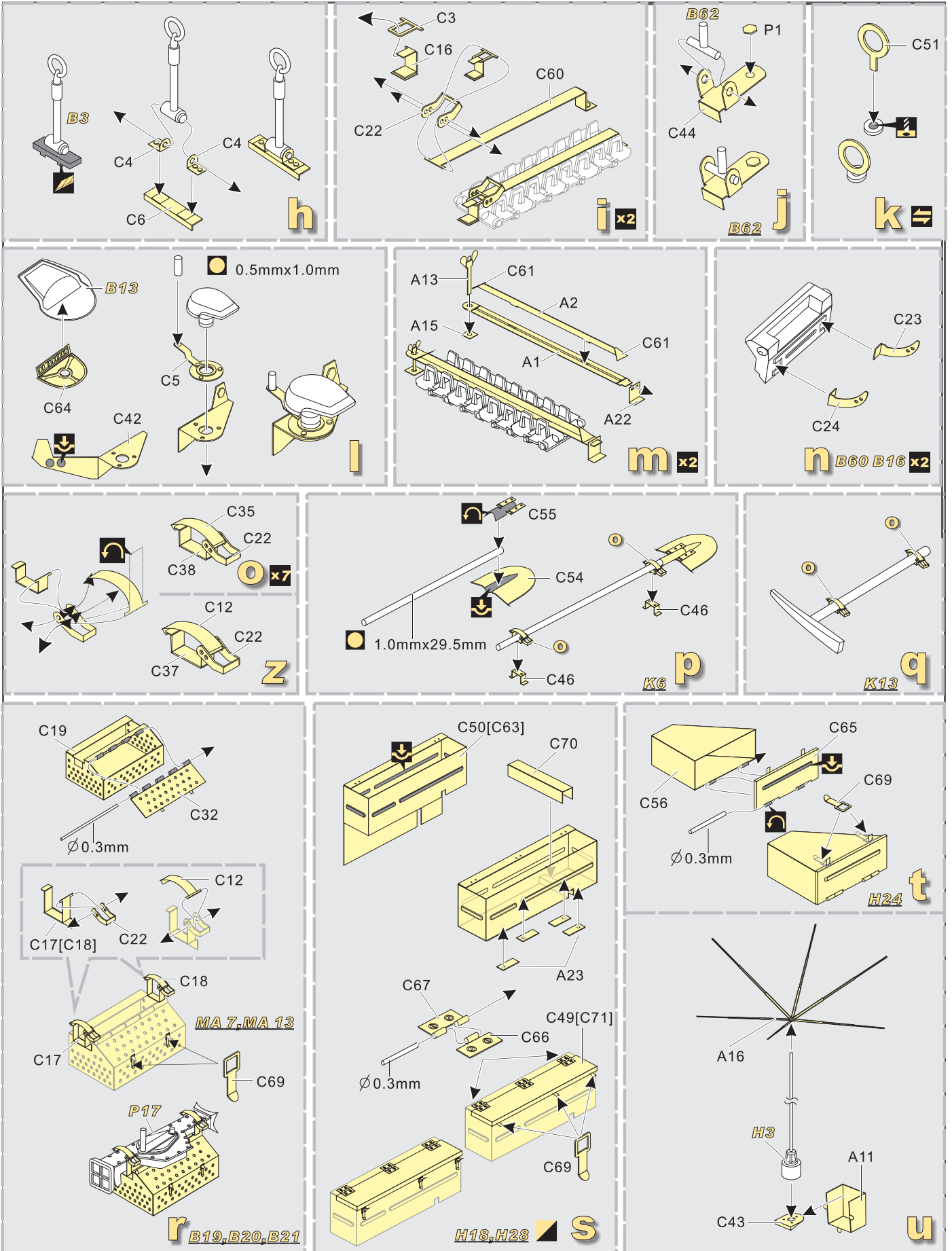

1/35 MILITARY MINIATURE VEHICLE UPGRADE SERIES PE35269

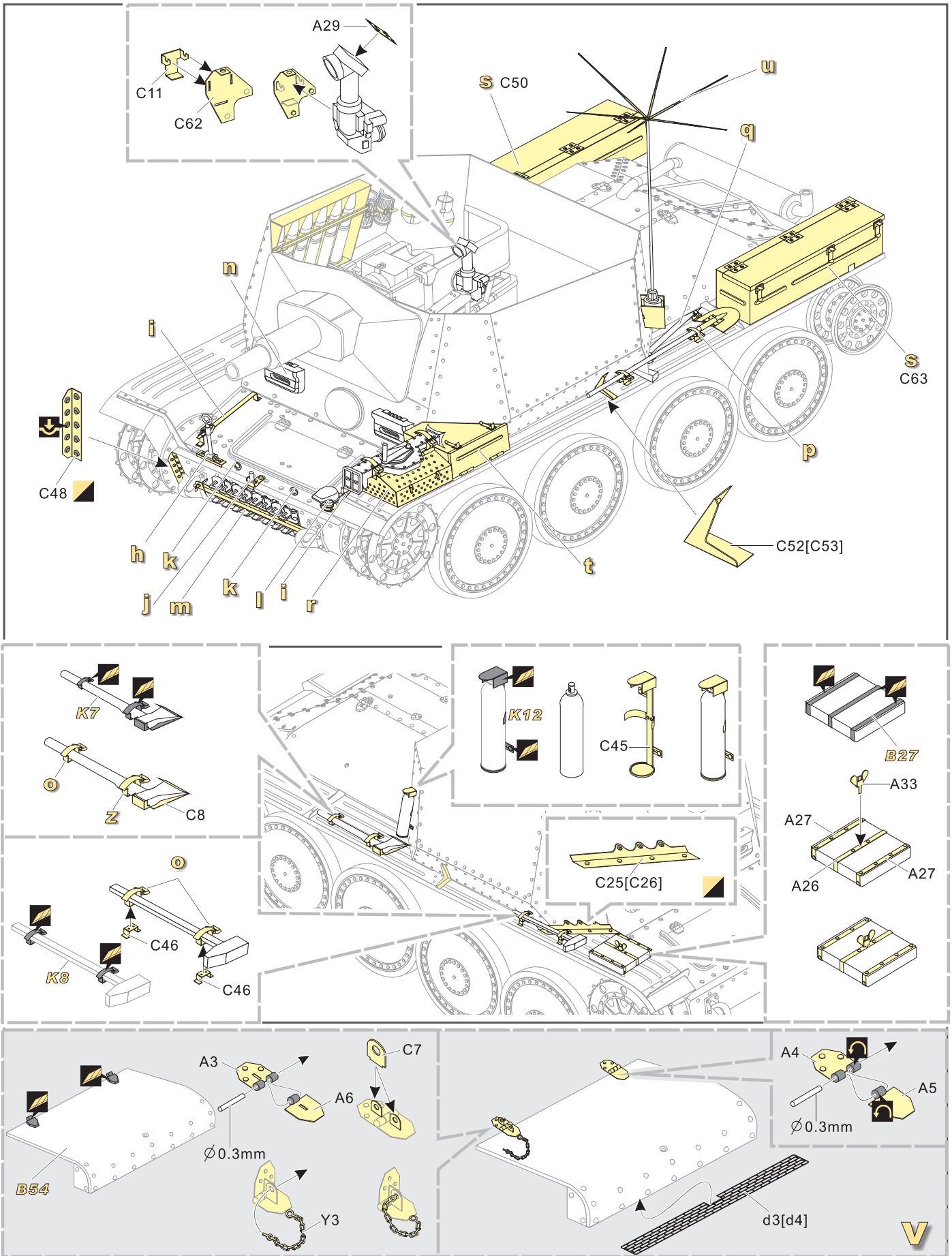

1/35 MILITARY MINIATURE VEHICLE UPGRADE SERIES PE35269

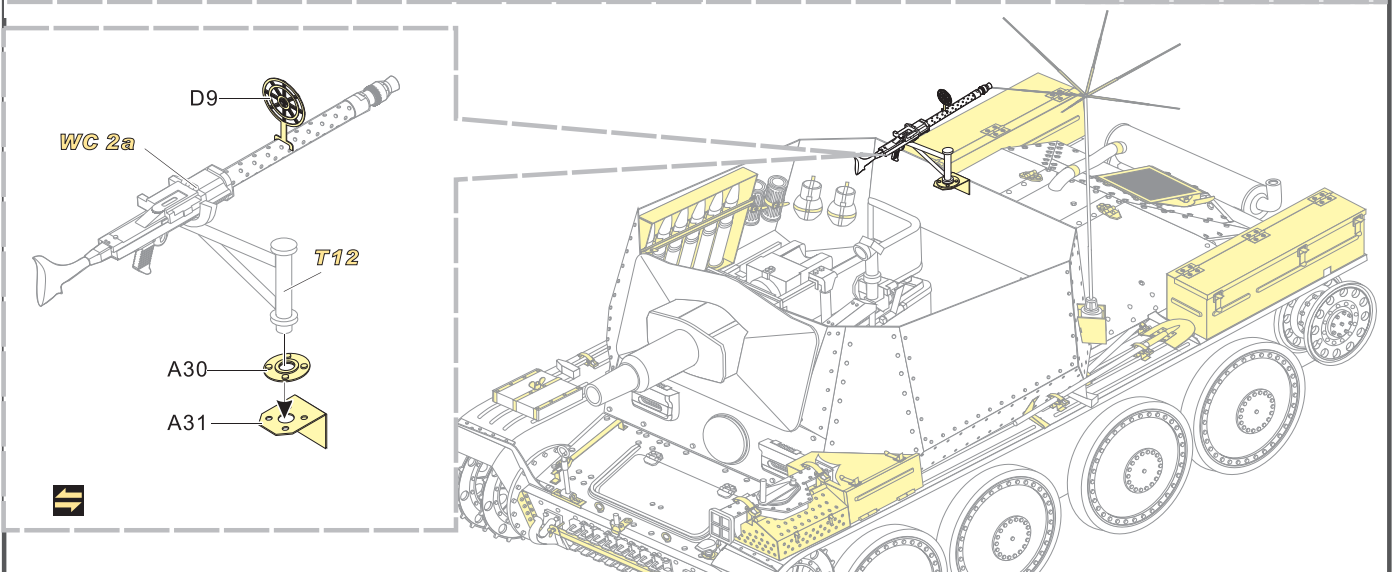
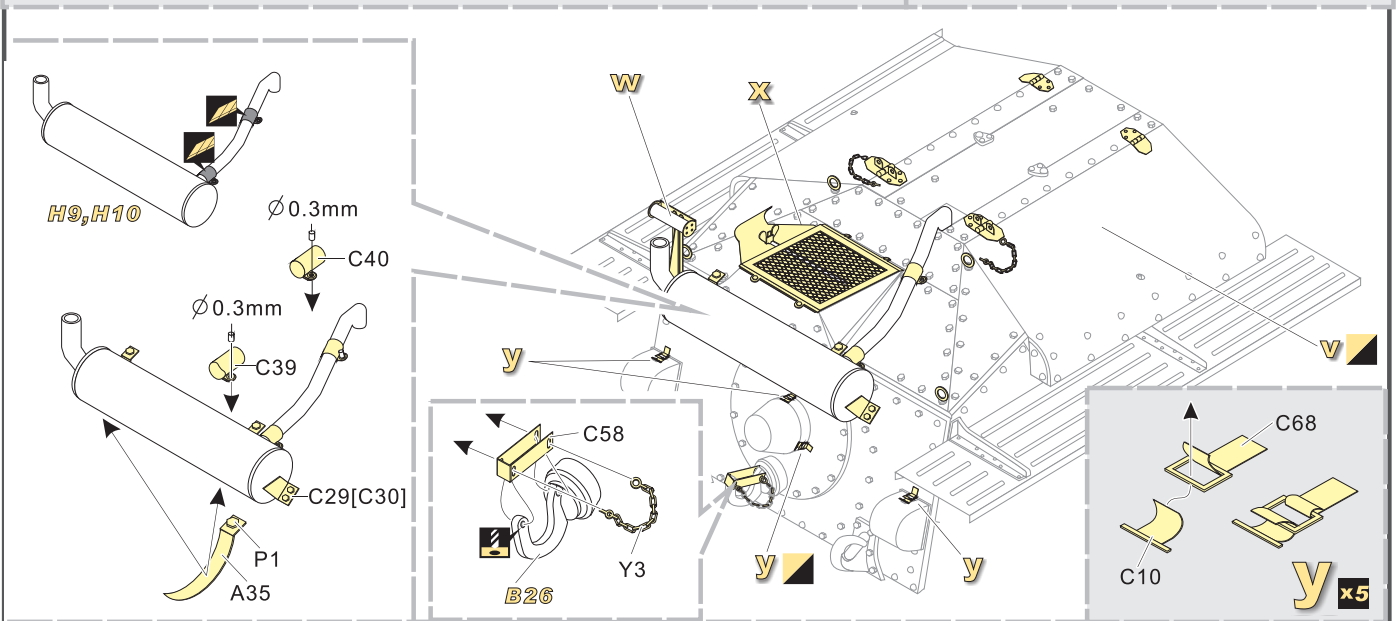
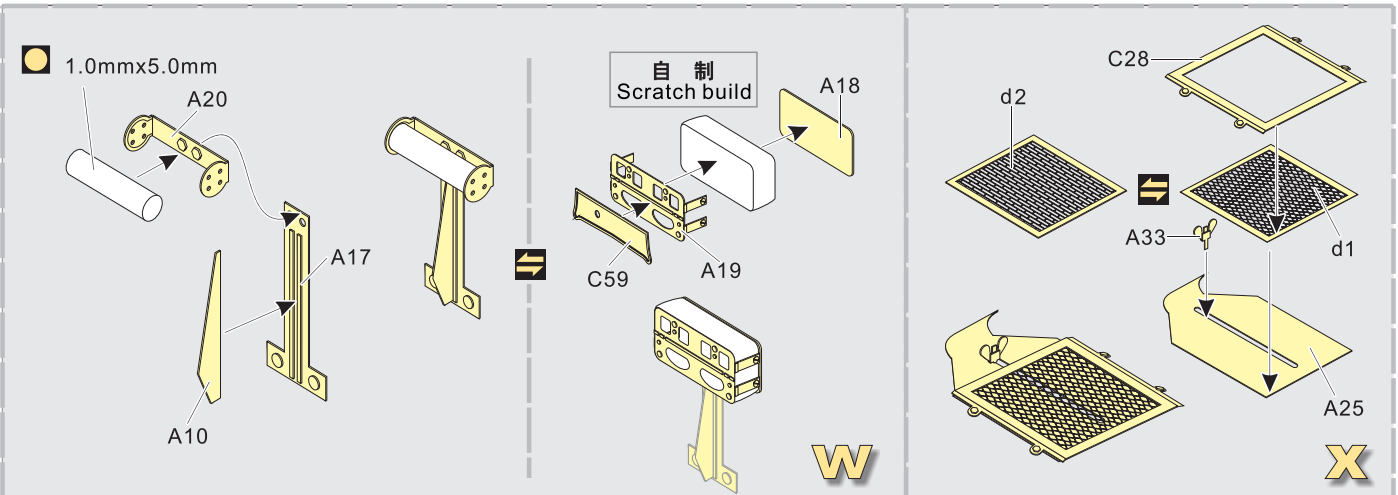

VOYAGERMODEL[®] 无微不至 极尽享受

Recommended item	
PE 35146	WWII German Pz.Kpfw.38(t) Fenders
PE 35270	WWII German Aufklarungspanzer 38(t) mit 75mm Kw.K Armour plate
VBS 0309	WWII German 75mm KwK 37/StuK 37 Ammunition
VBS 0310	WWII German 75mm KwK 37/StuK 37 Ammunition Shell Case