

Russian Su-27 Flanker B

俄罗斯Su-27"侧卫"B战斗机

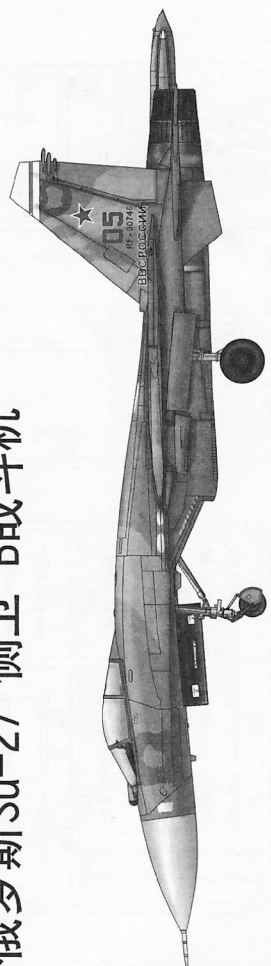

1/144 SCALE

READ BEFORE ASSEMBLY:

- Study and understand these instructions thoroughly before beginning assembly
- When needed, remove photo-etch parts carefully using a modeling knife or photo etch sprue cutter, being careful not to damage or lose small parts.
- Take extra care in handling photo etch parts in order to avoid injury
- Apply instant cement sparingly to photo etch parts where instructed
- Tools recommended (not included in kit): Plastic and instant cements, sprue cutters, long nose pliers, modeling knife, small files, tweezers, pin vise & scissors. Soft cloth and sandpaper will also assist in construction
- Glue and paint are not included in the kit. Use plastic cement and hobby paints only. Color guide for purchasing paint is included in the kit.

装配之前仔细阅读

- 小心用模型锉刀锉平所有零件表面的注射浇口。
- 小心用刀片切下蚀刻片零件，不要丢失小零件。
- 用强力的快干胶水粘合蚀刻片零件和金属轴。过量快干胶水使用可能导致零件会粘住，小心涂胶。
- 取蚀刻片时应特别注意安全，防止利边划伤手指。
- 某些零件表面需贴水上贴纸，请选择在装配的同时进行。
- 推荐模型工具(自备)：胶水、水口剪刀、长咀钳、刀片、锉刀、镊子、钻、针、剪刀，瞬间快干胶。
- 软布同砂纸同时也应该是必备工具。
- 请使用塑料胶水和油漆，模型内不含。



配重
Weight



使用强力胶
Cyanacrylate glue



钻孔
Make hole



切除
Cut / Remove



贴纸
Decal

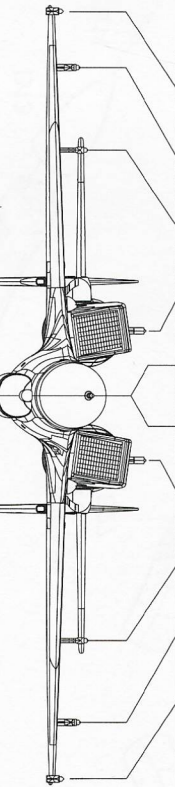

Sta.No.	1	2	3	4	5	6	7	8	9	10
Missile/Tank										
R-73E	●									
R-27R		●	●	●	●	●	●	●	●	●
R-27T			●	●	●	●	●	●	●	●

水贴纸的使用:

1. 从水贴纸上剪下印花;
2. 将印花放入温水中浸10秒, 然后放在干净布上.
3. 拿着印花纸板将印花移到模型上;
4. 手指蘸水将印花移到适当的位置;
5. 用软布轻压印花直至水干, 气泡消失

DECAL APPLICATION

1. Cut decals from sheet as needed with your finger.
2. Dip the decal in warm water for about 10 seconds and then place on soft clean cloth.
3. Hold the decal backing sheet edge and gently slide the decal into the model in its proper position.

4. While still wet, decal can be adjusted for better fit on model by dampening it gently with your finger.

5. When placed in the proper position, gently press decal down with a soft cloth until excess water and air bubbles are gone.
6. Allow decal to dry completely before handling model

部品图
Parts

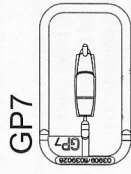
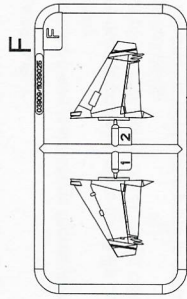
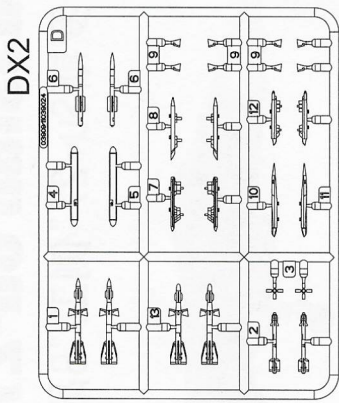
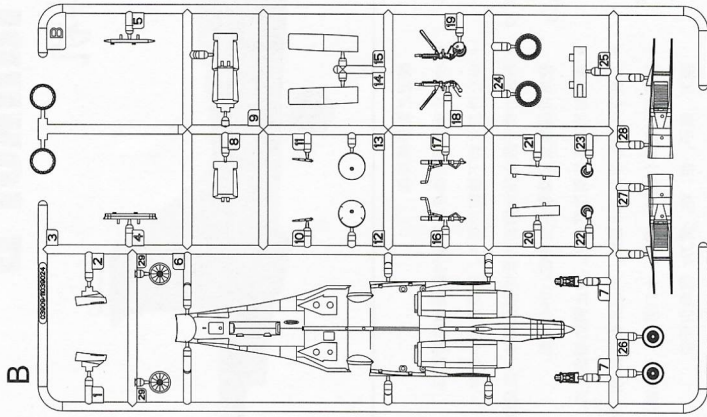

《上机身》
Top fuselage

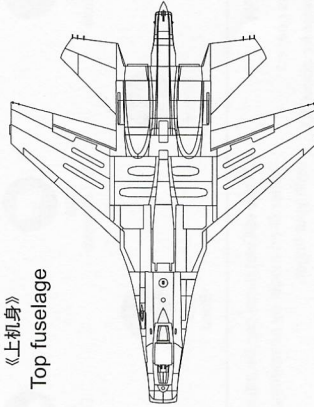

不用的部件: B3 B9 B10 B12 B18 B22 B23
Unused parts: D3 D6

《水贴》
Decal

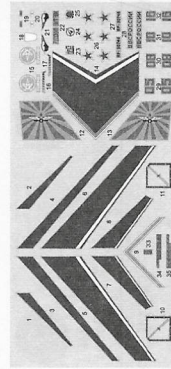

1

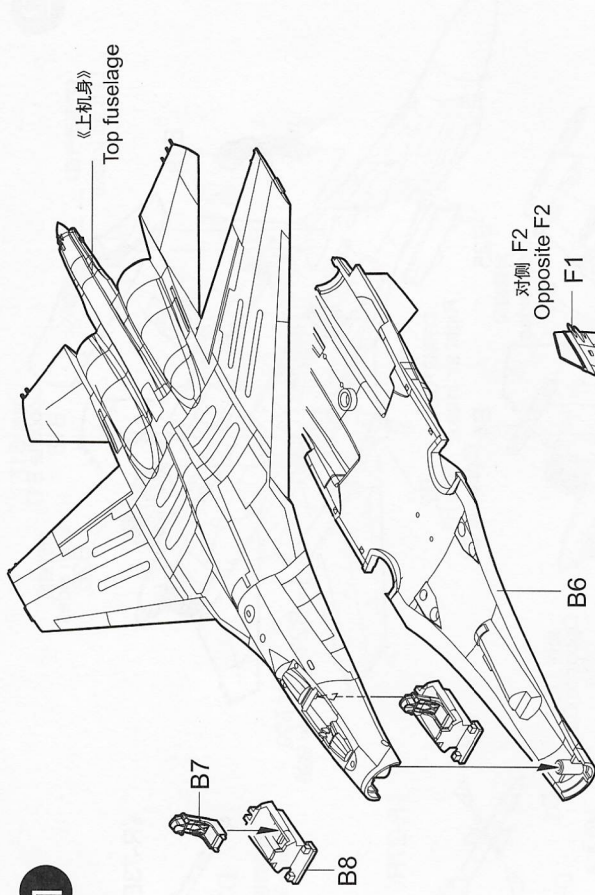

对侧 F2
Opposite F2

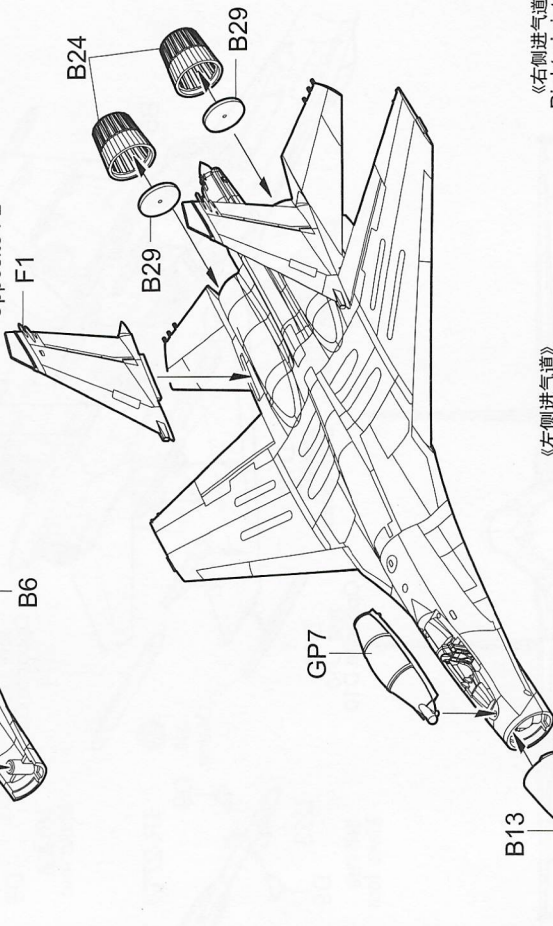

《右侧进气道》
Right air intake

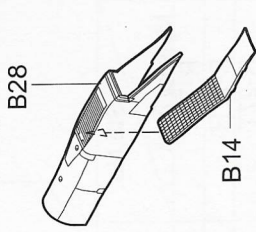

《左侧进气道》
Left air intake

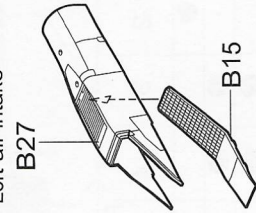

涂装同标贴指示
Painting & Marking guide

A Russian Air Force,
"Russian Knights",
Su-27, RF-90746, 05 Blue,
Zhuhai, Nov.2012

PAINT REFERENCE COLOUR

Color	Mr.Hobby	Vallejo	Model Master	Tamiya	Humbrol
红色 Red	H 3 3	908	1503	X7	19
银色 Silver	H 8 8	997	1546	X11	11
烧铁色 Burnt Iron	H 76 61	863	1795	X10	53
胎黑色 Tire black	H 77 137	-	-	-	-
透明红 Clear Red	H 90 47	934	-	X27	-
透明绿 Clear Green	H 94	936	-	X25	-
蓝色 + 光泽淡蓝 Blue + Light Blue	H 34 + H 4 4	-	-	-	-

PAINT REFERENCE COLOUR

Color	Mr.Hobby	Vallejo	Model Master	Tamiya	Humbrol
黑铁色 Metal Brown	H 18 28	864	1402	-	-
灰色 Dark gull grey	H 317 317	-	1740	XF54	140
浅灰色 Light Gray	H 338 338	71046	4765	XF14	147
天蓝 + 黄色 Flat black Yellow	H 34 + H 4 4	-	-	-	-
白色 White	H 1 1	71001	1745	X2	22
绿灰色 Light Green	H 319 319	-	1713	-	117
灰白色 Aircraft Gray	H 57 73	-	-	-	-

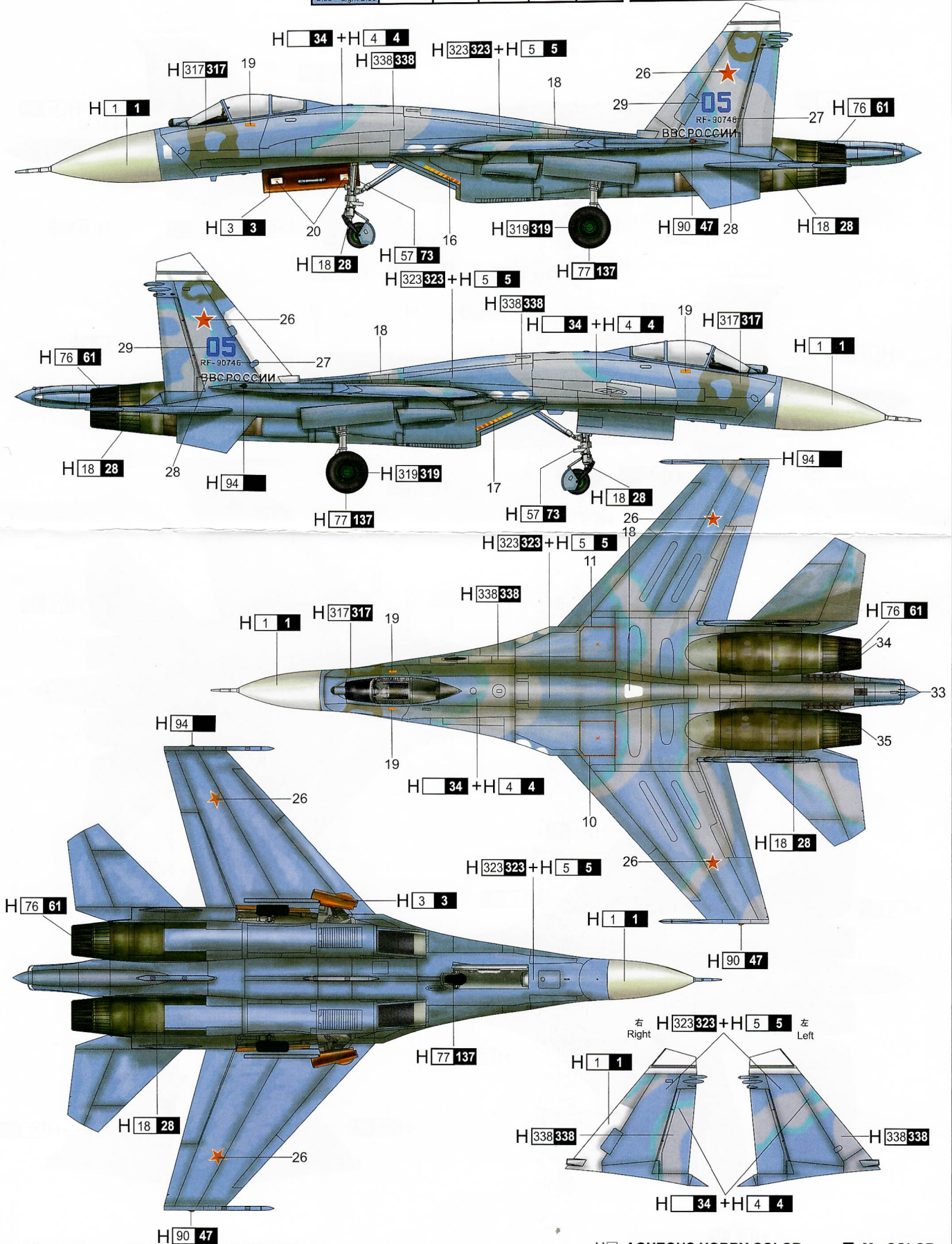

H X AQUEOUS HOBBY COLOR

X Mr. COLOR

涂装同标贴指示
Painting & Marking guide

B Russian Air Force,
"Russian Knights",
Su-27,Zhuhai,Nov.2012

PAINT REFERENCE COLOUR					
Color	Mr.Hobby	Vallejo	Model Master	Tamiya	Humbrol
红色 Red	H 3 3	908	1503	X7	19
银色 Silver	H 8 8	997	1546	X11	11
烧铁色 Burnt Iron	H 76 61	863	1795	X10	53
胎黑色 Tire black	H 77 137	-	-	-	-
透明红 Clear Red	H 90 47	934	-	X27	-
透明绿 Clear Green	H 94	936	-	X25	-

PAINT REFERENCE COLOUR					
Color	Mr.Hobby	Vallejo	Model Master	Tamiya	Humbrol
黑铁色 Metal Brown	H 18 28	864	1402	-	-
蓝色 Blue	H 328 328	71090	1772	-	190
钴蓝 Cobalt Blue	H 35 80	-	-	-	-
白色 White	H 1 1	71001	1745	X2	22
薄松叶色 Light Green	H 319 319	-	1713	-	117
灰白色 Aircraft Gray	H 57 73	-	-	-	-



H [] AQUEOUS HOBBY COLOR

[] Mr. COLOR