

AeroMaster

FROM THE
HAT IN THE RING TO
THE FLYING WING,



Aeromaster Decals™

3615 NW 20th Ave • Miami, Florida 33142 • USA
Tel. (305) 633-7398 • Fax (305) 638-4197

IPMS Columbus 97

"SCAT II"

P-38J "SCAT II", 479th Fighter Group, May through mid July 1944. This lightning carried the standard color scheme of Olive Drab uppersurfaces with Neutral Gray lowersurfaces, and had full D-Day invasion stripes added later on. It is unknown if nose art were carried on the opposite side, but extra decals are included. The spinner was either O.D., Red or natural metal. It is possible that a solid White circle was carried on the fin (decal 21).



INSIDE FINS
(Stbd. Shown)

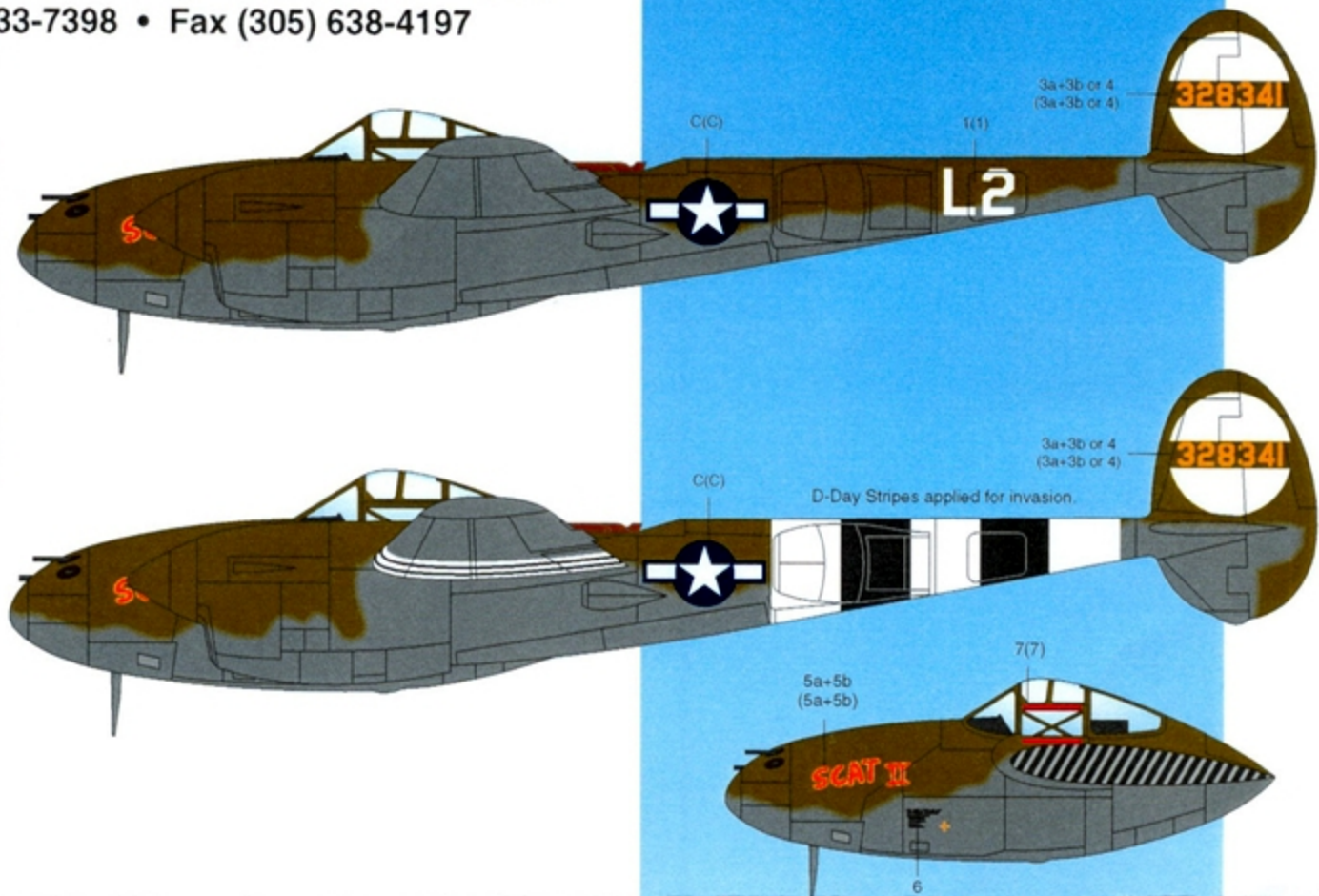

"SCAT #5"

P-51D, 44-14426 "SCAT 5", January through February 1945. Standard Aluminum finish with Red ruder. Kill markings may have been duplicated on stbd. side so an extra set is provided. European Theater stripes may have been applied, and also may have had thin White stripes along each side (decals 35).

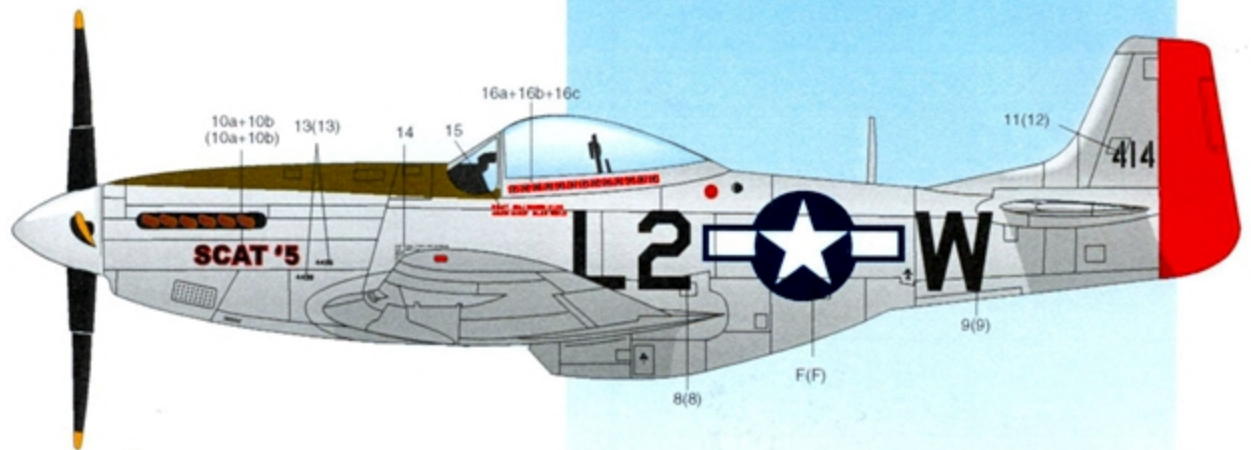

"SCAT VII"

P-51D, 44-72922 "SCAT VII", March 1945 to end of war. Standard Aluminum finish with Red ruder. Kill markings may have been duplicated on stbd. side so an extra set is provided.

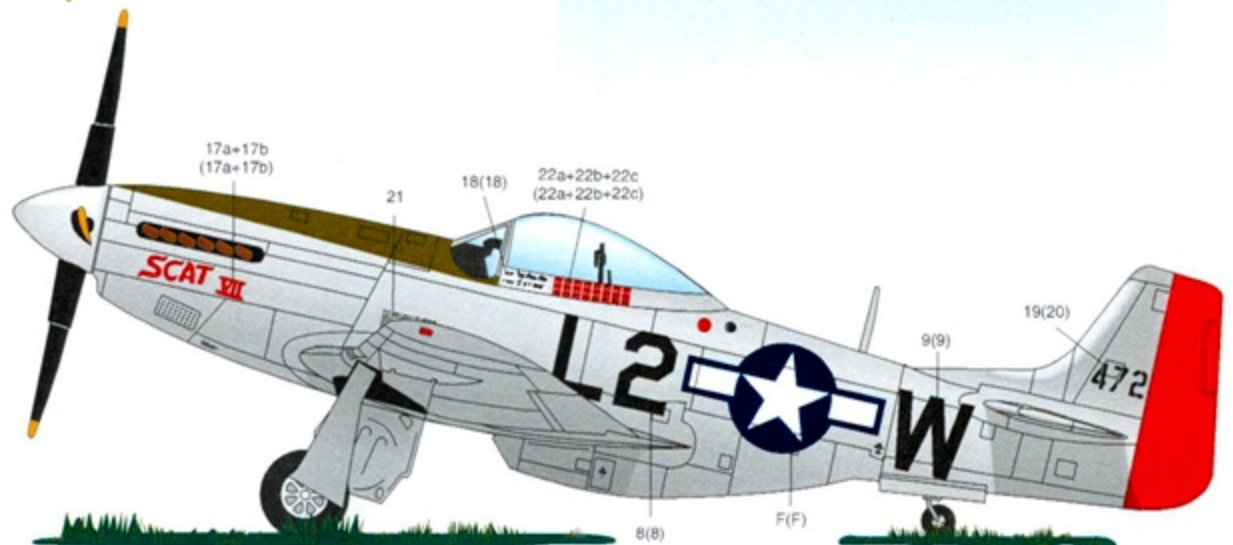

AeroMaster Decals™

P-38

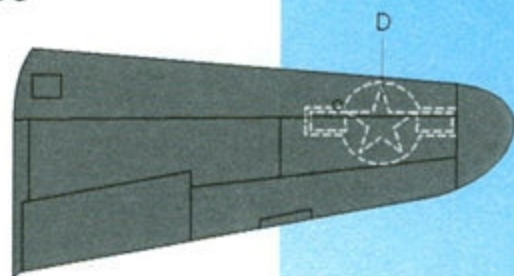
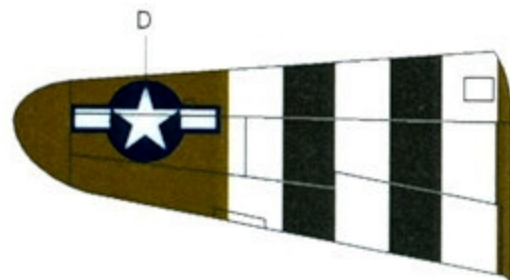

This project has been a joint venture of
Microscale, Ind. and AeroMaster Products.

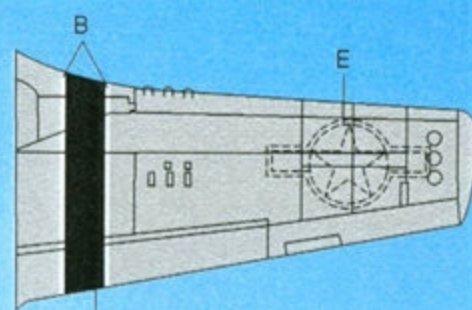
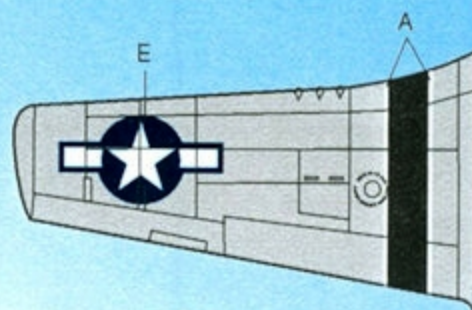
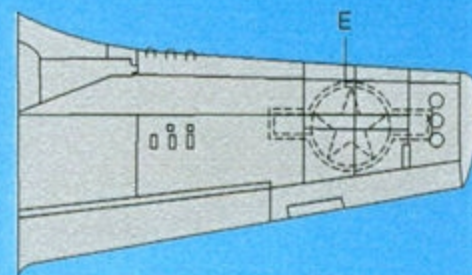
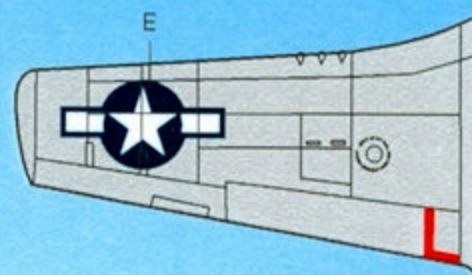

SCAT #5 had 15" black theater bands with thin white outlines (decals 35) on upper and lower wings.

Recommended AeroMaster Warbird Colors Enamels

9001	Black	9040	US Olive Drab 41
9002	White	9041	US O. Drab 41 Faded
9003	Yellow	9043	US Neutral Gray 43
9004	Blue		
9005	Red		
9010	Tire Black		

Recommended AeroMaster Warbird Colors Acrylic

1001	Gloss Clear	1040	US Olive Drab 41
1002	Semi-Gls Clr	1041	US O. Drab 41 Faded
1003	Flat Clear	1043	US Neutral Gray 43
1004	Tire Black		

NOTE:

On the decal sheet, those item numbers that are red are for 1/72 scale A/C, while those item numbers that are black are for 1/48 scale A/C. Build as you please!

Suggested Kits:

Minicraft P-38J
Tamiya P-51D
Hasegawa P-51D

References:

1. Original Photos & Interviews
2. Research by Mark Howard

have suggestions for future subject matter, AeroMaster would like to hear from you. Our goal is to provide high quality, well researched decals of unusual and interesting subjects. We value our customers' input, so if you have specific suggestions or photographs of unusual subject matter which you would be willing to share, please contact:

AeroMaster Decals™
3615 NW 20th Ave • Miami, Florida 33142 • USA

IPMS-97